

2 SPOKE CONTROL HANDWHEEL

D205



Material:

Reinforced and stabilised polyamide.
Oils and greases resistant.

Surface:

Satin.

Colour:

Black (RAL 9011).

Central Cap:

Grey polyamide (RAL 7035 cod. 13).

Alternative Cap Colour:

- Orange (RAL 2004 cod. 02)
- Blue (RAL 5015 cod. 07)
- Yellow (RAL 1021 cod. 10)
- Red (RAL 3000 cod. 16)
- Green (RAL 6024 cod. 17)
- Black (RAL 9011 cod. 01)

Main Insert:

Zinc plated steel insert with smooth through-hole (H10 tolerance).

Hub:

Solid hub.
(*) Hollow underneath hub.

For fixing system, or execution of keyway or square holes, please refer to the technical notes attached to the catalogue.

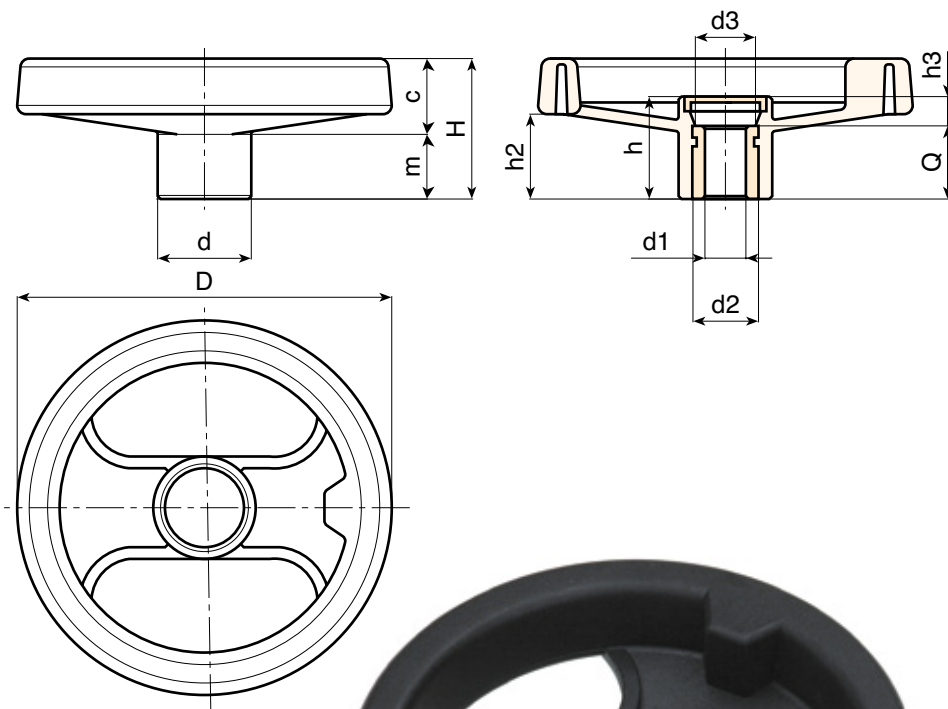

SPECIAL REQUEST:

- It's possible to supply the inserts with d1 bore by customer design, on request and for quantities.
- It's possible to supply the inserts in different material and treatment-finishes, on request and for quantities.
- It's possible to supply the products with colours (reduced range) as shown in the table at page D-19, on request and for quantities.

Version with zinc plated insert and H10 tolerance bore

Art.	D	H	h	d	m	c	h2	h3	d3	Dm	d1 H10	Q	g
D205080.TP0501P	80	34	26	24,5	16	18	20	6	16	12	05	20	94
D205100.TP0501P	99	43	33	28	20	23	26,5	9	16	16	05	24	152
D205130.TD0501P	129	50	36	32	21	29	32	12	26	18	05	24	240
D205160.TD0801P	159	57	40,5	40	22	35	34	8,5	26	22	08	32	390
D205200.TD0801P	198	61,5	39,5	51	17,5	44	33	7,5	26	22	(*) 08	32	630
D205250.TD0801P	252	70	47	55,5	24	46	39	11	24	28	(*) 08	36	920
D205350.TD0801P	346	80	49,5	67,5	24	56	43,5	17,5	35	30	(*) 08	32	1530

Attention: bore d1 (H10 tolerance) could be produced by request, with 50 pieces minimum.

Dm = It's possible to increase the hole, by boring, until Dm (enlarge).

Version with black-oxide insert and H7 tolerance bore

Art.	D	H	h	d	m	c	h2	h3	d3	Dm	d1 H7	Q	g
D205080.TD..01PZB	80	34	26	24,5	16	18	20	6	16	12	A.R.	20	94
D205100.TD..01PZB	99	43	33	28	20	23	26,5	9	16	16	A.R.	24	152
D205130.TD..01PZB	129	50	36	32	21	29	32	12	26	18	A.R.	24	240
D205160.TD..01PZB	159	57	40,5	40	22	35	34	8,5	26	22	A.R.	32	390
D205200.TD..01PZB	198	61,5	39,5	51	17,5	44	33	7,5	26	22	(*) A.R.	32	630
D205250.TD..01PZB	252	70	47	55,5	24	46	39	11	24	28	(*) A.R.	36	920
D205350.TD..01PZB	346	80	49,5	67,5	24	56	43,5	17,5	35	30	(*) A.R.	32	1530

Attention: replace the two places in the code .. with the hole diameter required - 50 pieces minimum.

Dm = It's possible to increase the hole, by boring, until Dm (enlarge). **A.R.** = By request

Presumable presence in the stock in %

(☺) 90% (☹) 40% (☹) 5% (☹) 5%

BOTECO® - © All right reserved - www.boteco.it

Any unauthorized reproduction is strictly forbidden



BOTECO