

SIŁA TRZYMANIA / HOLDING FORCE -  $F = 210 \text{ kg}$

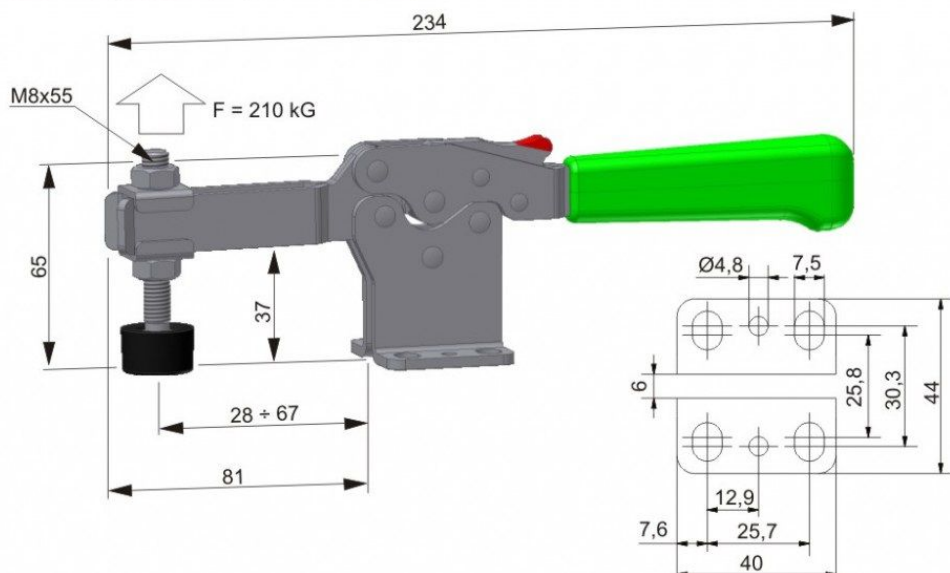

WAGA / WEIGHT - 0,43 kg

PODSTAWA / BASE

SIŁA TRZYMANIA / HOLDING FORCE -  $F = 320 \text{ kg}$

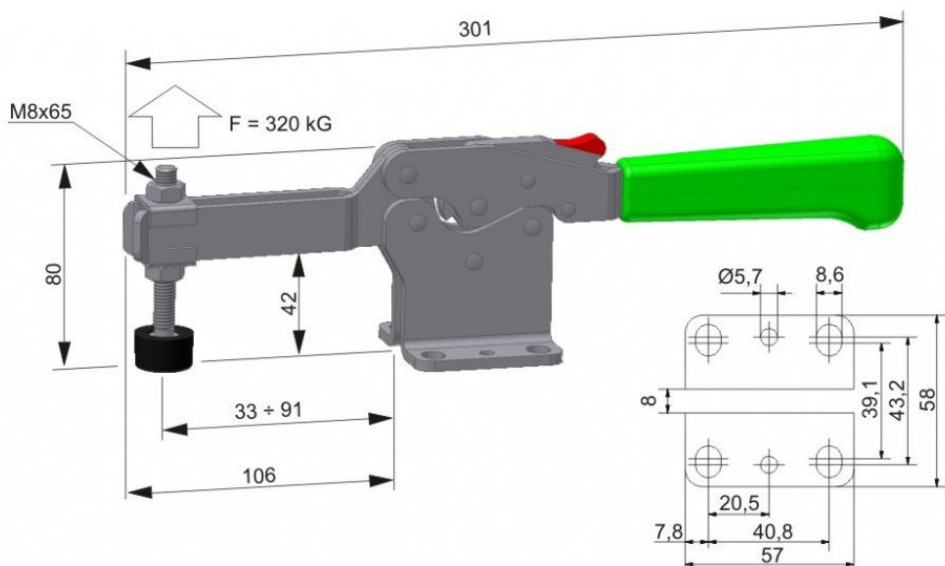

WAGA / WEIGHT - 0,88 kg

PODSTAWA / BASE

SIŁA TRZYMANIA / HOLDING FORCE -  $F = 500 \text{ kg}$

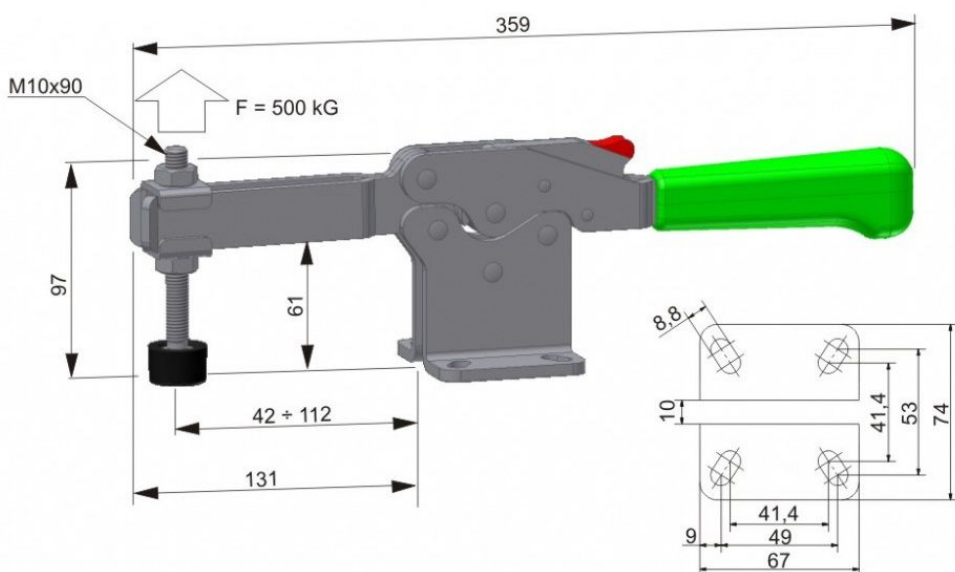

WAGA / WEIGHT - 1,56 kg

PODSTAWA / BASE