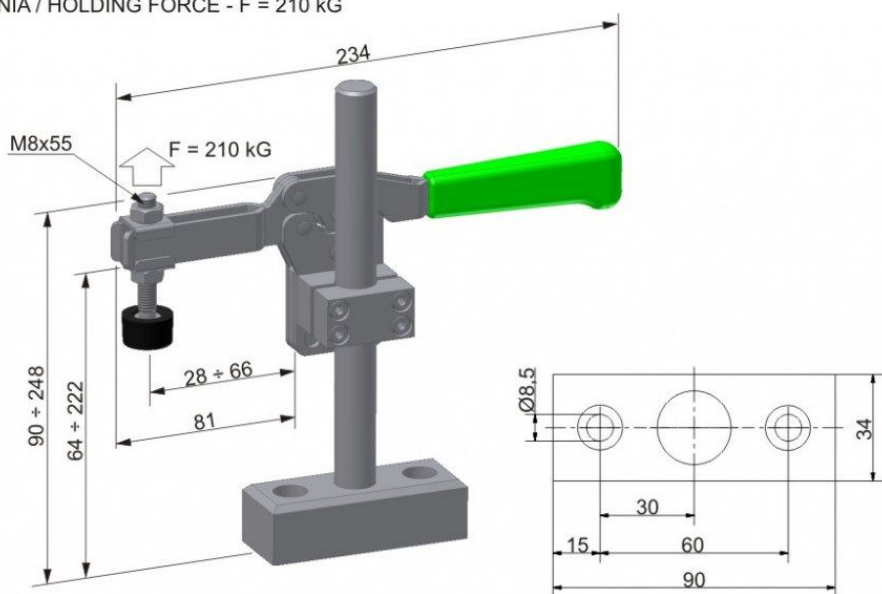
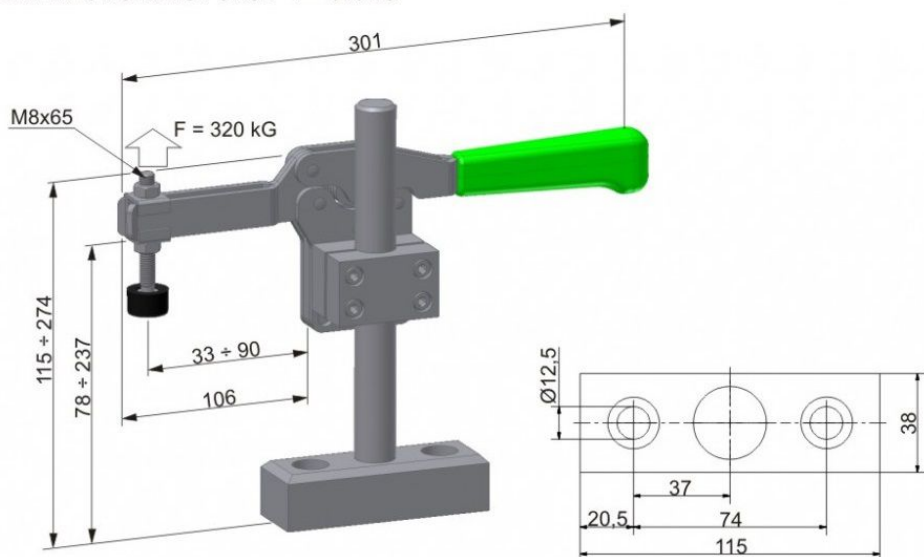

SIŁA TRZYMANIA / HOLDING FORCE - $F = 210 \text{ kG}$ 

WAGA / WEIGHT - 1,40 kg

PODSTAWA / BASE

SIŁA TRZYMANIA / HOLDING FORCE - $F = 320 \text{ kG}$ 

WAGA / WEIGHT - 2,80 kg

PODSTAWA / BASE

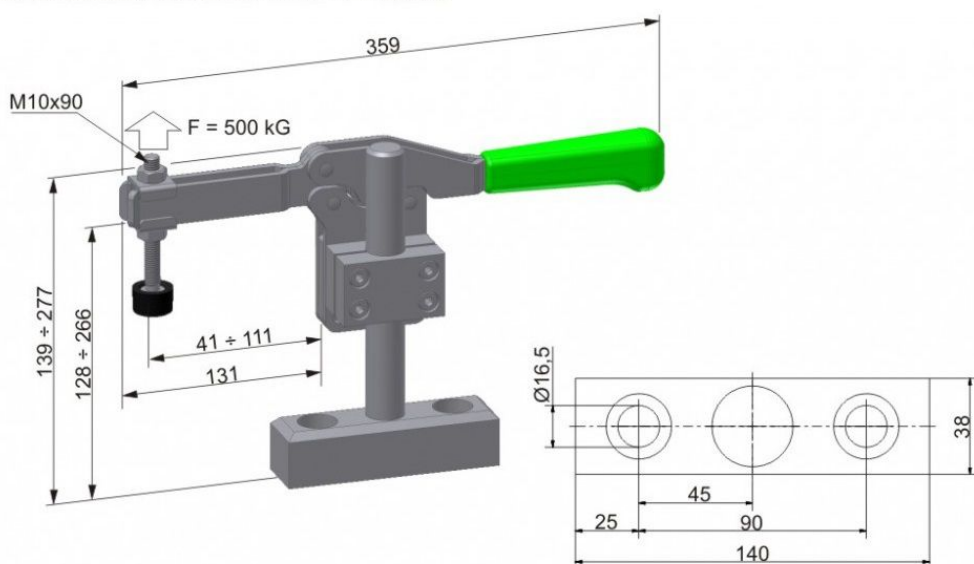
SIŁA TRZYMANIA / HOLDING FORCE - $F = 500 \text{ kG}$ 

WAGA / WEIGHT - 4,08 kg

PODSTAWA / BASE