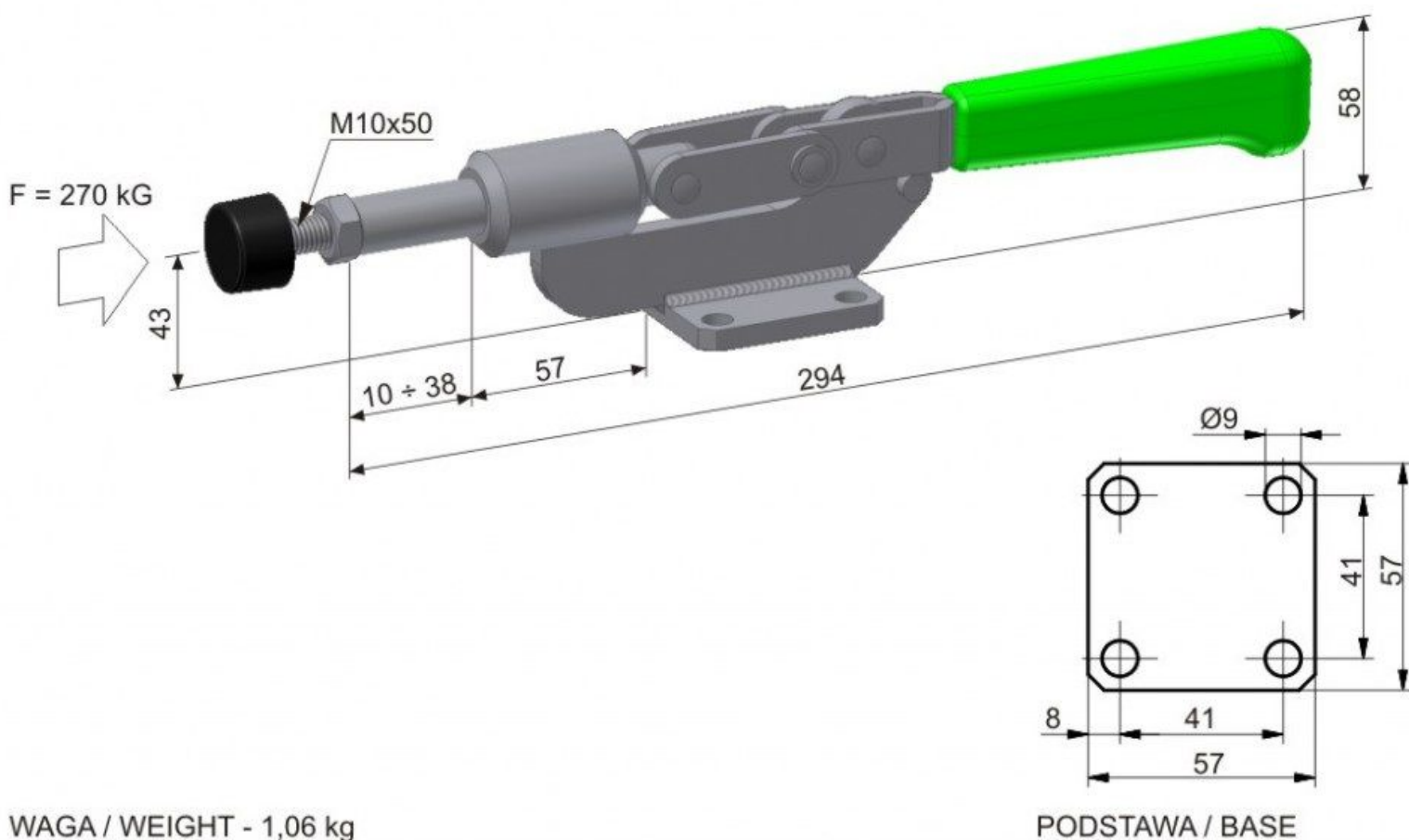

SIŁA TRZYMANIA / HOLDING FORCE - $F = 270$ kGSIŁA TRZYMANIA / HOLDING FORCE - $F = 340$ kG