

TECHNICAL REFERENCE

- EtherCAT Communication Specifications -

MODEL

Product name: AC servo amplifier

Product No.: MINAS-A5B series (EtherCAT communication/rotation type)

Issued on

May.08, 2013

Revised on

Jan.08, 2016

Motor Business Unit, Smart Factory Solutions Business Division
Automotive & Industrial Systems Company, Panasonic Corporation

7-1-1 Morofuku, Daito-City, Osaka 574-0044, Japan

Phone: +81-72-871-1212

Fax : +81-72-870-3151

この英文仕様書は、原本である和文仕様書を元にパナソニック株式会社オートモーティブ&インダストリアルシステムズ社モータビジネスユニットが翻訳・発行するものです。翻訳は、原本の利用に際して一応の参考となるように便宜的に仮訳したものであり、公的な校閲を受けたものではありません。英語訳のみを使用して生じた不都合な事態に関しては、当社は一切責任を負うものではありません。和文仕様書のみが有効です。

パナソニック株式会社
オートモーティブ&インダストリアルシステムズ社 モータビジネスユニット

This English specification is made and published by Motor Business Unit Automotive & Industrial Systems Company of Panasonic Corporation based on the original Japanese specification. Translation is provided unofficially only for the sake of convenience of utilizing the original Japanese specification as a measure of reference. It is not officially reviewed. Motor Business Division Appliances Company of Panasonic Corporation is not liable for any disadvantages caused by utilizing only English specification. Only the Japanese specification is effective.



Motor Business Unit, Automotive & Industrial Systems Company,
Panasonic Corporation

REVISIONS

Date	Page	Rev.	Description	Signed
May.08, 2013	-	1.00	First edition	
May.24,2013	-	1.01	Clerical errors are corrected and Supplementary explanations are added.	
Nov. 29, 2013	-	1.02	Functions are added. pv, tq, polarity and others are supported.	
	-		Clerical errors are corrected and Supplementary explanations are added.	
Jan. 14, 2014	-	1.03	Functions are added. The EtherCAT communication monitor of the positioning completion (INP) is supported.	
	-		Clerical errors are corrected and Supplementary explanations are added.	
Feb. 10, 2014	-	1.04	Clerical errors are corrected and Supplementary explanations are added.	
Sep. 17, 2014	-	1.05	Clerical errors are corrected.	
May.29,2015	2	2.00	Software upgrade Ver1.01 -> Ver3.01 * Added a function of the following 1)-6)	
	85, 252, 273		1) Function addition "Mode of 2 degrees of freedom control (Standard type, Synchronization type)"	
	231, 264		2) Function addition "Single-turn absolute function"	
	86, 87, 111, 112, 119-120,150, 171,277		3) Function addition "Max motor speed of csp mode" (Amount of change saturation function of command position)	
	88,150,171,272, 273		4) Function addition "Fall prevention function in the event of alarms / Servo-ON"	
	132,232		5) Function addition "Err94.3 (Home position return error protection 2)"	
	112,114,116, 164,165,167, 182,183,185		6) Function addition "Drive follows command value Setting conditions switching"	
			Other	
	27		Added the description of unsupported Mailbox type of Mailbox frame structure	
	29		Added the description of Emergency Message.	
	87,150,171		Added the description of 60B2h(Torque offset(TFF)) . (During slowdown in over-travel inhibition, the torque feedforward level becomes 0)	
	131,134-145		Added the description of hm mode of Switch signal(HOME、 POT、 NOT).	
	187		Added the Notes of the touch probe.	
	27		Clerical errors are corrected and Correction the description of Mailbox time out.	
	79		Correction the description of 6041h(Statusword) bit11(internal limit active).	
	84		Clerical errors are corrected and Correction of Position control block diagram.	
	84,148,169		Clerical errors are corrected and Correction the Notes of block diagram.	

Note: The page number (Page) is the current page number at the time of revision.

REVISIONS

Date	Page	Rev.	Description	Signed
May.29,2015	-	2.00	(Continued from previous page)	
	96		Clerical errors are corrected and Correction of pp mode block diagram.	
	98,113,124, 155,164,175, 182,217,277		Clerical errors are corrected and Correction the description of Electronic gear related objects(608Fh,6091h,6092h).	
	111		Clerical errors are corrected and Correction of csp mode block diagram.	
	122		Clerical errors are corrected and Correction of hm mode block diagram.	
	153		Clerical errors are corrected and Correction of pv mode block diagram.	
	163		Clerical errors are corrected and Correction of csv mode block diagram.	
	174		Clerical errors are corrected and Correction of tq mode block diagram.	
	181		Clerical errors are corrected and Correction of cst mode block diagram.	
	162,168, 180,186		Clerical errors are corrected and Correction the description of “servo ON”. “servo ON” ->” servo ON(Operation enabled command)”	
	187		Clerical errors are corrected and Correction the description of “Touch Probe Function”.	
	198		Clerical errors are corrected and Correction the description of 3507h	
	211		Clerical errors are corrected and Correction the description of Digital outputs (60FEh)	
	212		Clerical errors are corrected and Correction of state the output transistor of set brake.	
	215		Clerical errors are corrected and Correction the description of Electronic gear setting example.	
	218		Clerical errors are corrected and Correction the description of Polarity(607Eh).	
	242		Clerical errors are corrected and Correction the description in causes of Err81.1.	
	246		Clerical errors are corrected and Correction the description in causes of Err81.7.	
	250		Clerical errors are corrected and Correction the description in causes of Err85.3.	
	259		Clerical errors are corrected and Correction the description of the Object Dictionary List of H.	
	171,276		Clerical errors are corrected and Correction the description of 6071h of EEPROM attribute. “No” ->”Yes”	
Jun.23, 2015	2	3.00	Software upgrade Ver1.01 -> Ver3.01 * Added a function of the following 1)	
	112,119		1) Function addition “Selecting Invalid/Valid of 6080h(Max motor speed) on csp mode”	
Jan.08, 2016	2	4.00	Software upgrade Ver3.02 -> Ver3.04 * Added a function of the following 1)-5)	
	131, 232		1) Function addition “Home position reference trigger(HOME, POT, NOT, EXT1, EXT2) b-contact setting function”	
	129,222, 223,277		2) Function addition “Clearing multi-turn data via EtherCAT ”	
	30,256		3) Function addition “Read warning code via EtherCAT”	
	132,275		4) Function addition “Homing return speed limit function”	
	91,92,151,152, 172,173,277		5) Function addition “Over load factor Monitor ”	
			Other	
	2		Added the description of driver of size M	

Note: The page number (Page) is the current page number at the time of revision.

REVISIONS

Date	Page	Rev.	Description	Signed
Jan.08, 2016	-	4.00	(Continued from previous page)	
	147		Added the Notes of the hm mode Method 35,37	
	211		Added the description of set brake	
	239,240		Added the description of "Err80.6 PLL error protection" and "Err80.7 Synchronization signal error protection"	
	131		Clerical errors are corrected and Correction the description of Homing Position Mode	
	242		Clerical errors are corrected and Correction the description of "Err80.7 Synchronization signal error protection"	

Note: The page number (Page) is the current page number at the time of revision.

Contents

1 Introduction	1
1-1 Start-up guide	3
1) Preparation and connection (Mainly refer to Chapter 2 and Chapter 3).....	3
2) Communication establishment (Mainly refer to Chapter 3 and Chapter 5).....	3
3) Object settings (Mainly refer to Chapter 6)	4
4) Motor operation (Mainly refer to Chapter 6)	5
5) When the motor does not operate.....	6
6) About PANATERM.....	6
2 System Overview	7
2-1 EtherCAT Overview	8
2-2 Reference Materials	9
2-3 System Configuration (master & slave configuration).....	10
2-4 Specification List	11
3 EtherCAT Communication Specification	12
3-1 EtherCAT Frame Configuration.....	13
3-2 ESM (EtherCAT State Machine)	15
3-3 ESC Address Space.....	17
3-4 SII (Slave Information Interface) EEPROM	19
3-4-1 SII Area (0000h to 003Fh).....	20
3-5 Synchronous Communication Mode	22
3-5-1 DC (synchronous with SYNC0 event).....	23
3-5-2 SM2 (synchronous with SM2 event)	24
3-5-3 Free RUN (asynchronous)	25
3-6 SDO (Service Data Object).....	26
1) Mailbox frame configuration	26
2) Mailbox timeout.....	27
3-6-1 Message at Error Occurrence.....	28
1) Abort Message	28
2) Emergency Message	29
3-7 PDO (Process Data Object).....	32
3-7-1 PDO Mapping Object	33
3-7-2 PDO Assign Object.....	34
3-8 Front Panel Configuration.....	35
3-8-1 EtherCAT Indicators.....	35
1) RUN.....	36
2) ERR.....	36
3) L/A IN.....	36
4) L/A OUT.....	36
3-8-2 Node addressing (Setting Station alias)	37
1) Reading the value of SII from Configured Station Alias	38
2) Reading the value of rotary switch from Configured Station Alias	38
3) Reading the value of rotary switch from AL Status Code (Explicit Device ID).....	39

4 Common Object Specification	40
4-1 Object Configuration.....	41
5 CoE Communication Area (1000h to 1FFFh)	42
5-1 Object List.....	43
5-2 Device Information	45
5-3 Sync Manager Communication Type (1C00h).....	47
5-4 PDO (Process Data Object) Mapping	48
5-4-1 PDO Assign Object (1C12h to 1C13h).....	48
5-4-2 PDO Mapping Object (1600h to 1603h, 1A00h to 1A03h)	49
5-4-3 Default PDO Mapping	51
5-4-4 PDO Mapping Setting Procedure.....	53
5-5 Sync Manager 2/3 Synchronization (1C32h, 1C33h).....	55
5-5-1 DC (synchronous with SYNC0 event).....	59
5-5-2 SM2 (synchronous with SM2 event)	61
5-5-3 Free RUN (asynchronous)	63
5-5-4 Input shift time	65
5-6 Store Parameters (write object in EEPROM) (1010h)	66
5-7 Diagnosis history (Reading Function of Error (alarm) History) (10F3h).....	67
6 Drive Profile Area (6000h to 6FFFh)	69
6-1 Object List.....	72
6-2 PDS (Power Drive Systems) Specification	74
6-2-1 Finite State Automaton (FSA)	74
6-3 Controlword (6040h).....	76
6-4 Statusword (6041h)	78
6-5 Operation mode Setting.....	80
6-5-1 Supported Drive Modes (6502h)	80
6-5-2 Modes of Operation (6060h).....	81
6-5-3 Modes of Operation Display (6061h)	82
6-5-4 Precautions for Changing Operation mode	83
6-6 Position Control Function(pp,csp,ip,hm)	84
6-6-1 Common Position Control Function	84
1) Position control block diagram	84
2) Related objects common in position control (command & setup)	86
- Position system	87
- Velocity system	87
- Torque system	87
- Acceleration and deceleration system	88
- Software position limit (607Dh).....	89
3) Related objects common in position control (monitoring).....	91
- Position system	92
- Velocity system	92
- Torque system	92
- Statusword (6041h) <Common functions in position control>	93

6-6-2 Profile Position mode (pp mode)	96
1) Objects related to pp mode (command & setup)	97
- Controlword (6040h) <Functions in pp mode>	99
- Positioning option code (60F2h)	101
2) Objects related to pp mode (monitoring)	104
- Statusword (6041h) <Functions in pp mode>	105
3) Operations of pp mode	106
- Example 1 (basic set-point)	106
- Example 2 (Data change in operation, without buffer: Single set-point)	107
- Example 3 (Data change in operation, with buffer: Set of set-points)	108
- Example 4 (Buffering of set-points)	109
- Example 5 (Temporary stop by halt)	110
6-6-3 Cyclic Position Mode (csp mode)	111
1) Objects related to csp mode (command & setup)	112
- Controlword (6040h) <Functions in csp mode>	114
- Position system	114
2) Objects related to csp mode (monitoring)	115
- Statusword (6041h) <Functions in csp mode>	116
3) Operations of csp mode	117
4) Calibration process on the occurrence of communication error	118
5) Amount of change saturation function of command position	119
6-6-4 Interpolating Position Mode (ip mode) (Not supported)	121
6-6-5 Homing Position Mode (hm mode)	122
1) Objects related to hm mode (command & setup)	123
- Controlword (6040h) <Functions in hm mode>	125
- Homing method (6098h)	126
- Homing speeds (6099h)	127
- Homing acceleration (609Ah)	127
2) Objects related to hm mode (monitoring)	128
- Statusword (6041h) <Functions in hm mode>	129
- Supported homing method (60E3h)	130
3) Operations of hm mode (Homing operation)	131
- Homing error occur conditions	133
- Method 1	134
- Method 2	135
- Method 3, 4	136
- Method 5, 6	137
- Method 7, 8, 9, 10	138
- Method 11, 12, 13, 14	139
- Method 17	140
- Method 18	141
- Method 19, 20	142
- Method 21, 22	143
- Method 23, 24, 25, 26	144
- Method 27, 28, 29, 30	145
- Method 33, 34	146
- Method 35, 37	147
6-7 Velocity Control Function	148
6-7-1 Common Velocity Control Function	148
1) Velocity control block diagram	148
2) Related objects common in velocity control (command & setup)	149
- Velocity system	150
- Torque system	150
3) Related objects common in velocity control (monitoring)	151
- Position system	152
- Velocity system	152
- Torque system	152

6-7-2 Profile Velocity Mode (pv mode)	153
1) Objects related to pv mode (command & setup)	154
- Controlword (6040h) <Functions in pv mode>	156
- Velocity system	157
- Acceleration and deceleration system	157
2) Objects related to pv mode (monitoring)	158
- Statusword (6041h) <Functions in pv mode>	159
3) Operations of pv mode	162
6-7-3 Cyclic Velocity Mode (csv mode)	163
1) Objects related to csv mode (command & setup)	164
- Controlword (6040h) <Functions in csv mode>	165
2) Objects related to csv mode (monitoring)	166
- Statusword (6041h) <Functions in csv mode>	167
3) Operations of csv mode	168
6-8 Torque Control Function	169
6-8-1 Common Torque Control Function	169
1) Torque control block diagram	169
2) Related objects common in torque control (command & setup)	170
- Velocity system	171
- Torque system	171
3) Related objects common in torque control (monitoring)	172
- Position system	173
- Velocity system	173
- Torque system	173
6-8-2 Profile Torque Mode (tq mode)	174
1) Objects related to tq mode (command & setup)	175
- Controlword (6040h) <Functions in tq mode>	176
- Torque system	177
2) Related objects (monitoring)	178
- Statusword (6041h) <Functions in tq mode>	179
- Torque system	179
3) Operations of tq mode	180
6-8-3 Cyclic Torque Mode (cst mode)	181
1) Objects related to cst mode (command & setup)	182
- Controlword (6040h) <Functions in cst mode>	183
2) Objects related to cst mode (monitoring)	184
- Statusword (6041h) <Functions in cst mode>	185
3) Operations of cst mode	186
6-9 Common Motion Function	187
6-9-1 Touch Probe Function (position latch request/release)	187
1) Configuration of touch probe function	188
2) Touch probe relevant object	189
3) Touch probe function (60B8h)	190
4) Touch probe status (60B9h)	191
5) Touch probe position 1/2 positive value (60BAh - 60BDh)	192
6) Starting touch probe operation	193
7) Event mode of touch probe	194
6-9-2 Option Code (deceleration stop sequence)	196
1) Abort connection option code(6007h)	198
2) Quick stop option code(605Ah)	201
3) Shutdown option code(605Bh)	203
4) Disable operation option code (605Ch)	205
5) Halt option code (605Dh)	206
6) Fault reaction option code (605Eh)	207
7) Sequence at drive inhibition input (POT, NOT)	208

6-9-3 Digital Inputs/Digital Outputs.....	209
1) Digital inputs (60FDh).....	210
2) Digital outputs (60FEh).....	211
6-9-4 Position information	213
1) Initialization timing of position information.....	213
2) Electronic Gear Function.....	214
3) Polarity(607Eh).....	218
4) Initialization of the absolute encoder.....	220
5) Position range limit (607Bh).....	224
6) Home offset (607Ch)	225
6-9-5 Jerk.....	226
6-9-6 Interpolation time period (60C2h)	227
7 Servo Parameter Area (3000h to 3FFFh).....	228
7-1 Object Overview	229
8 EtherCAT Relevant Protection Functions	230
8-1 Error (alarm) List (attribute and LED display).....	231
1) EtherCAT communication-related error(alarm).....	231
2) Error unrelated to EtherCAT communication(alarm)	232
8-2 EtherCAT-related details of error(alarm).....	234
1) Inaccurate ESM demand error protection (Err80.0).....	234
2) ESM undefined request error protection (Err80.1).....	235
3) Bootstrap requests error protection (Err80.2).....	236
4) Incomplete PLL error protection (Err80.3)	237
5) PDO watchdog error protection (Err80.4).....	238
6) PLL error protection (Err80.6).....	239
7) Synchronization signal error protection (Err80.7).....	240
8) Synchronization cycle error protection (Err81.0).....	242
9) Mailbox error protection (Err81.1).....	243
10) PDO watchdog error protection (Err81.4).....	244
11) DC error protection (Err81.5).....	245
12) SM event mode error protection (Err81.6).....	246
13) SyncManager2/3 error protection (Err81.7)	247
14) TxPDO assignment error protection (Err85.0).....	248
15) RxPDO assignment error protection (Err85.1).....	249
16) Lost link detection error protection (Err85.2)	250
17) SII EEPROM error protection (Err85.3)	251
18) Main power undervoltage protection (AC insulation detection 2) (Err88.0)	252
19) Control mode setting error protection (Err88.1).....	253
20) ESM requirements during operation error protection (Err88.2).....	254
21) Improper operation error protection (Err88.3)	255
8-3 Reading Error (alarm)	256
8-4 Clear error (alarm)/Clear warning.....	257
8-5 Other, error(alarm) / warning related function.....	258
9 Object Dictionary List.....	259
10 Glossary of Terms.....	282
10-1 Glossary of Terms	283

1 Introduction

1-1 Start-up guide.....	3
1) Preparation and connection (Mainly refer to Chapter 2 and Chapter 3).....	3
2) Communication establishment (Mainly refer to Chapter 3 and Chapter 5).....	3
3) Object settings (Mainly refer to Chapter 6)	4
4) Motor operation (Mainly refer to Chapter 6)	5
5) When the motor does not operate.....	6
6) About PANATERM.....	6

This document is intended to describe the specification of the network interface EtherCAT to connect between the servo amplifier MINAS-A5B series (slave) and upper controller (master).

<Software version>

This document is to apply to the servo amplifiers of the software versions below:

Version1: Ver.3.04

Version2: Ver.3.04

Version3: Ver.1.00



* If there is no distinction among the software versions 1, 2, and 3 in this document, “software” indicates all of the three versions.

* Check the software versions 1 and 2 by 3744h (Reference to section 5-2) or setup support software PANATERM.

* Check the software version 3 by 100Ah (Reference to section 5-2).

* In this software version, the following functions are not supported. The descriptions about these functions in the document may be changed without a preliminary announcement when they are supported.

Item	Not supported item						
Device profile	FoE (File over EtherCAT)						
Modes of Operation	<ul style="list-style-type: none"> Semi-closed mode <table border="1" style="margin-left: 20px;"> <thead> <tr> <th>Servo loop</th> <th colspan="2">Modes of operation</th> </tr> </thead> <tbody> <tr> <td>position</td> <td>ip</td> <td>Interpolate position mode</td> </tr> </tbody> </table> Full-closed mode All modes of operation. 	Servo loop	Modes of operation		position	ip	Interpolate position mode
Servo loop	Modes of operation						
position	ip	Interpolate position mode					
Motion	Jerk						
SDO message	Complete Access						

<Target user>

This document is intended for those who design upper controller for the servo amplifier MINAS-A5B series.

<Related document>

SX-DSV02471: Reference specifications (Hardware relevant specification mainly)

SX-DSV02913: Reference specifications (Hardware relevant specification of driver of size M mainly)

* This document lists the reference specification number based on the drivers other than M size.

In the case of size M, Please replace the reference specification number in this document from "SX-DSV02471" to "SX-DSV02913".

SX-DSV02472: Technical document (Basic function specifications)

<Precautions>

- (1) No part or whole of the contents in this document may be reused or reproduced without our written permission.
- (2) The contents (specification, software version, etc.) of this document is subject to change without prior notice due to the improvement of the product.



1-1 Start-up guide

A schematic procedure until it can operate with a motor simple substance by pp control is described.

Note: This section is only for reference and does not guarantee the operation.
Some descriptions including those for the homing operation are omitted.
For details, refer to this document and the specifications issued by ETG.

1) Preparation and connection (Mainly refer to Chapter 2 and Chapter 3)

- Connect a master with a slave , and a motor with a slave.
- In EtherCAT communication, the ESI file (xml file) which indicated EtherCAT slave information is needed. Please save the ESI file offered from our company at the preservation place of the ESI file specified by the master.
- A master generates ENI based on ESI offered from our company (using a configuration tool), and builds an EtherCAT network using ENI.(Refer to the operation manual of a master for details.)
- Station alias is set up.

As for the value of Configured Station Alias(0004h) of SII, 0 is set up at the time of shipment.

When it set up Station Alias by front RSW, once switch on a power supply, write 3741h=0 in EEPROM, and set up Station Alias by RSW after turning off a power supply.

(The range of Station Alias which can be set up only by RSW is 0-255. When it set up 256 or more, refer to section 3-8-2.)

Alternatively, setting through AL Status Code (Explicit Device ID) is available. For details, refer to section 3-8-2.

The master reads the set values of the Configured Station Alias (0012h) of the ESC register and sets them to the Configured Station Address (0010h).

Thereby addresses such as FPRD commands used in the mailbox are set.

- Switch on a power supply.
Switch on both the main power and the control power.
Check 7 segment LED in the front after power activation, and check that the error has not occurred.

2) Communication establishment (Mainly refer to Chapter 3 and Chapter 5)

- According to an ENI file, a master performs communicative initialization and construction. It is necessary to set up as follows in DC mode as an example of a setup.
(When setting is DC mode, the cycles of 2ms and time until it latches data is 250us.)
1C32h-01h=2(DC), 1C32h-02h=2000000(ns)
1C33h-01h=2(DC), 1C33h-03h=2500000(ns)
- The clearance of ESC each register, The check of VendorID/ ProductCode etc., A setup of Station Alias, An ESC register is set up (SyncManager/FMMU for MailBOX) and an ESM state is made to change from Init to PreOP.
- After checking that the ESM state has changed to PreOP, a setup (DC, SyncManager/FMMU for PDO) of an ESC register is carried out, and an ESM state is made to change from PreOP to SafeOP.
- After checking that the ESM state has changed to SafeOP, an ESM state is made to change from SafeOP to OP.

The change state of the EtherCAT application layer

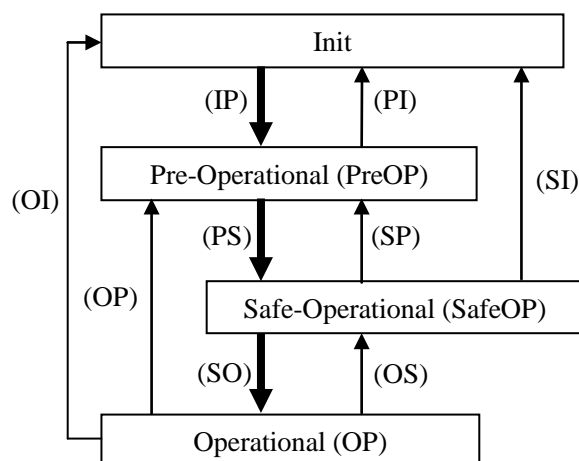

3) Object settings (Mainly refer to Chapter 6)

- The example of a setting for carrying out absolute position arrangement operation as shown in the following figure by pp control is described.
- In order to operate a motor by pp, operation mode (6060h:Modes of operation) is changed.
Set up 6060h=1(pp).
- A target position (607Ah:Target Position) is changed.
Set up 607Ah=50000000(command).
- If the setting of 607Dh (Software position limit) is enabled, the operation range is limited.
 For details, refer to section 2) in 6-6-1.
- A target speed (6081h:Profile velocity) is changed.
Set up 6081h=2000000(command/s).
- Speed is limited by the set value of 607Fh(Max profile velocity) and 6080h (Max motor speed).
 For details, refer to section 2) in 6-6-1.
- A acceleration (6083h: Profile acceleration) is changed.
Set up 6083h=5000000(command/s²).
- Speed is limited by the set value of 60C5h (Max acceleration).
 For details, refer to section 2) in 6-6-1.
- A deceleration (6084h: Profile deceleration) is changed.
Set up 6084h=2500000(command/s²).
- Speed is limited by the set value of 60C6h (Max deceleration).
 For details, refer to section 2) in 6-6-1.

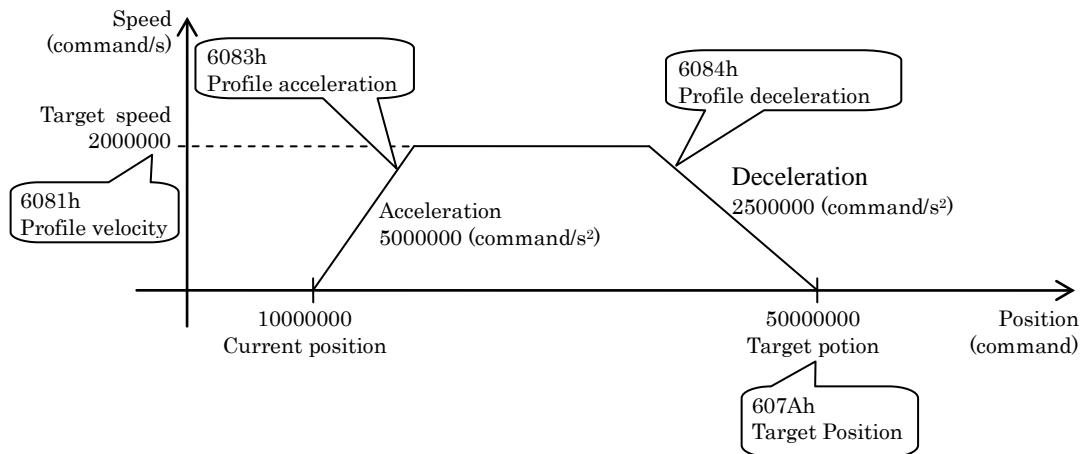

4) Motor operation (Mainly refer to Chapter 6)

- There is a PDS (Power Drive Systems) state in EtherCAT communication, the state of the motor is expressed. This PDS can be changed by the object 6040h(Controlword), and reference of a state can be performed at 6041h(Statusword). Be sure to transmit the changes instructions to the following state, after checking that the state had changed at 6041h(Statusword).
- A PDS state is changed from "Switch on disabled" to "Ready to switch on".
Please set up 6040h=0006h(2:Shutdown), check that 6041h changes from xx40h to xx21h.
- A PDS state is changed from "Ready to switch on" to "Switched on".
Please set up 6040h=0007h(3:Switch on), check that 6041h changes from xx21h to xx23h.
- A PDS state is changed from "Switched on" to "Operation enabled".
Please set up 6040h=000Fh(4:Enable operation), check that 6041h changes from xx23h to xx27h.
It will be in servo ON state by becoming 6041h=xx27h.
- In order to start pp operation, bit4(new set point) of 6040h is changed from 0 to 1.
bit5(change set immediately), bit6(absolute/relative) and bit9(change on set-point) remains at 0.
Please set up 6040h=001Fh.
Motor starts to operate.
- A PDS state is changed from "Operation enabled" to "Switched on", servo-off is carried out.
Please set up 6040h=0007h(5: Disable operation), check that 6041h changes from xx27h to xx23h.

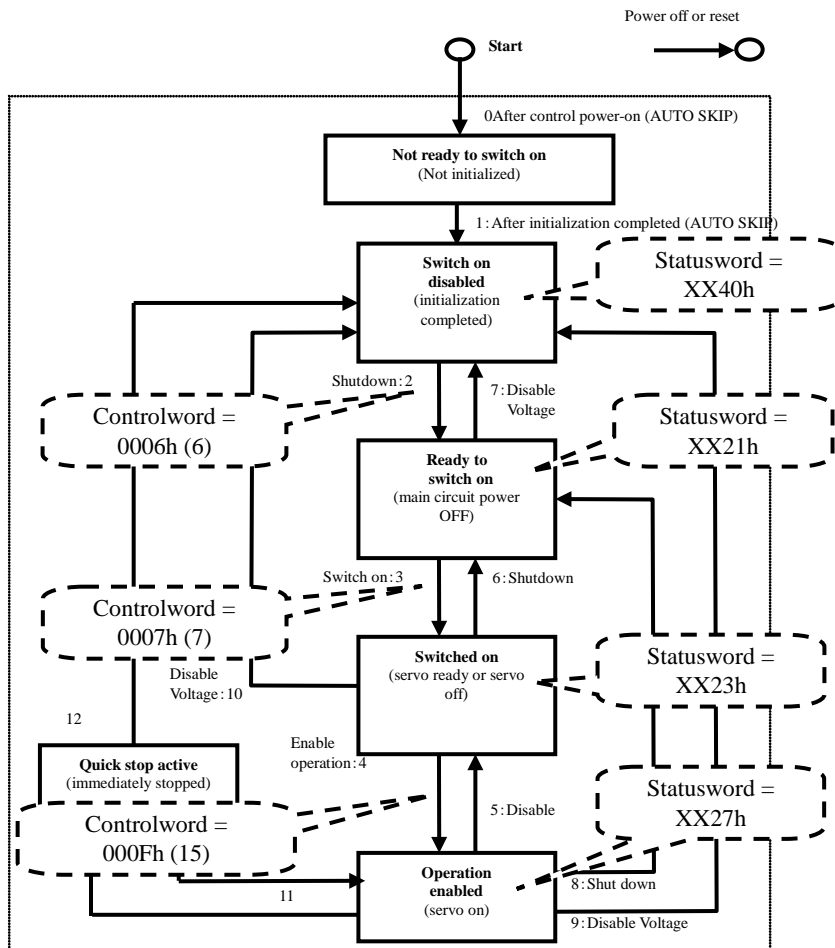

5) When the motor does not operate

- When servo-on is not performed, before the PDS state inside amplifier changes, there is a possibility of having transmitted the changes commands to the following state. Transmit the changes commands to the following state after checking that the PDS change state has been completed.
- Although servo-on is carried out, when the motor does not operate, there may be inaccurate setting object. Check the settings of the object.

In particular, make sure that the motor operation is not limited by objects that set a maximum value, such as 6080h (Max motor speed), or objects that set an operation range, such as 607Dh (Software position limit).

If bit 11 (internal limit active) of 6041h (Statusword) is 1, internal limitation is imposed. Refer to “6-4. Statusword (6041h)” to eliminate the cause of the internal limitation.

- When alarm is occurred, remove the factor of alarm after referring to Chapter 8 “EtherCAT Relevant Protection Functions” of this document or Chapter 7 “Protective function/Alarm function” in technical reference functional specification (SX-DSV02472).

After factor of alarm is removed, perform alarm clear after referring to Section 8-4 “Clear error (alarm)/Clear warning” of this document.

6) About PANATERM

We will prepare a setup support software "PANATERM" in the MINAS-A5B.

The following thing is function in PANATERM.

- A reading and writing of a servo parameter.
- A reading and writing of a object. *1)
- The status monitor of Internal amplifier, an input/output terminal.
- The detailed display of alarm, a history display, a clearance.
- Graphical display of a motor operation waveform
- A test run, frequency characteristic measurement *2)
- etc.

Please refer to the operation manual of PANATERM for details.

- *1) If writing (editing) an object using the object editor, it is necessary to set the ESM status to Init.

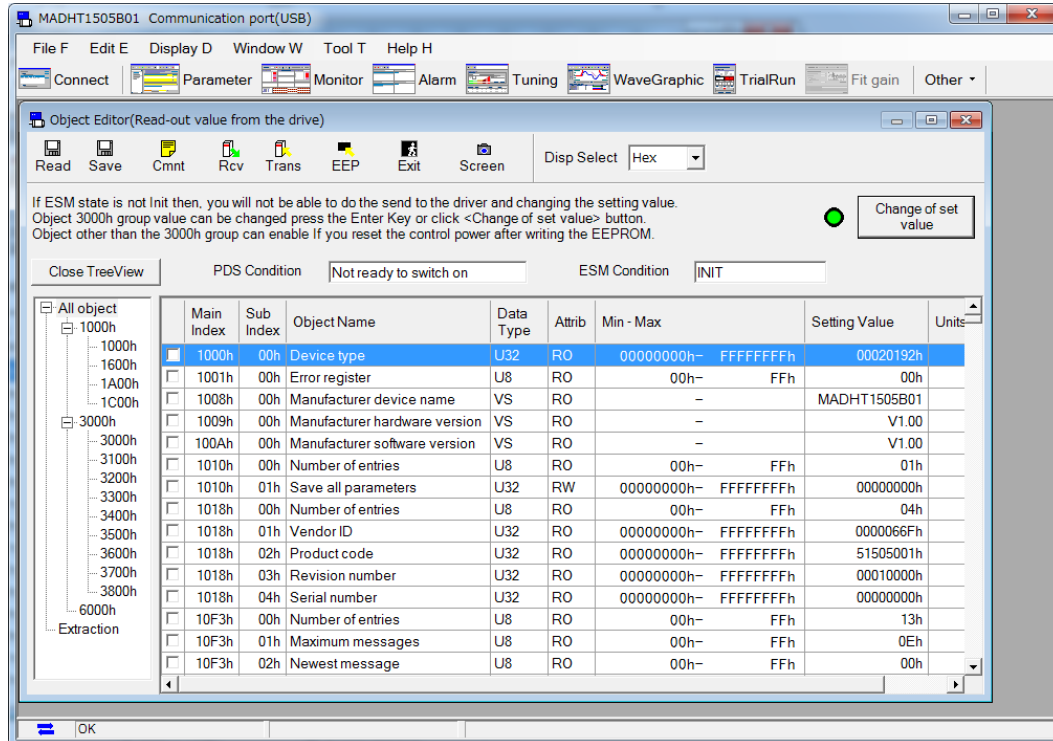

- *2) To use a test run and a frequency characteristic measurement function, it is necessary to set an ESM state to Init.

Also, at this time, Velocity offset, Torque offset, and Torque limit from the EtherCAT communication are cleared.

2 System Overview

2-1 EtherCAT Overview	8
2-2 Reference Materials	9
2-3 System Configuration (master & slave configuration).....	10
2-4 Specification List	11

2-1 EtherCAT Overview

EtherCAT is an abbreviation of Ethernet for Control Automation Technology. It is an open network communication between master and slaves using real time Ethernet developed by Beckhoff Automation GmbH and is administered by ETG (EtherCAT Technology Group).

This product has passed the EtherCAT Conformance Test.

EtherCAT[®] is registered trademark and patented technology,
licensed by Beckhoff Automation GmbH, Germany.

The logo for EtherCAT, featuring the word "EtherCAT" in a bold, sans-serif font. The "CAT" part is significantly larger and bolder than "Ether". To the right of the "T" is a stylized arrow pointing to the right, composed of two parallel horizontal lines with a triangular arrowhead.

2-2 Reference Materials

This document is created with reference to the following article.

(Note) About the difference of the written contents of this document and the following reference data, the written contents of this document become effective.

It does not guarantee all the description of the reference materials that are not described in this document.

Number	Document	Type	State	Version	Date
ETG.1000.2	EtherCAT Specification - Part2 - Physical Layer service and protocol specification	S	R	V1.0.2	2010.01.07
ETG.1000.3	EtherCAT Specification - Part3 - Data Link Layer service definition	S	R	V1.0.2	2010.01.07
ETG.1000.4	EtherCAT Specification - Part4 - Data Link Layer protocols specification	S	R	V1.0.2	2010.01.07
ETG.1000.5	EtherCAT Specification - Part5 - Application Layer service definition	S	R	V1.0.2	2010.01.07
ETG.1000.6	EtherCAT Specification - Part6 - Application Layer protocol specification	S	R	V1.0.2	2010.01.07
ETG.1020	Protocol Enhancements	S	R	V1.0.0	2011.08.09
ETG.1300	Indicator and Labeling	S	R	V1.1.0	2012.01.27
ETG.2000	Slave Information	S	D	V1.0.2.2	2011.11.14
ETG.6010	Implementation Directive for CiA402 Drive Profile	D	R	V1.0.0	2012.02.02

Number	Document	Type	State	Version	Date
IEC61800-7-200 (201)	Adjustable speed electrical power drives systems - Profile type 1 specification	-	-	Ed.1.0	2007.8.10
IEC61800-7-300 (301)	Adjustable speed electrical power drives systems - Mapping of profile type 1 to network technologies	-	-	Ed.1.0	2007.8.10

Number	Document	Type	State	Version	Date
ET1815/ET1817	EtherCAT Slave Controller IO core for xilinx FPGAs IP core Release 2.04a	-	-	1.0	2011.3.15

2-3 System Configuration (master & slave configuration)

The connection type of EtherCAT is a network system that connects master (FA controller) and multiple slaves with a line (*Note: For other than line connection, send an inquiry to us separately).

The number of connectable nodes of slaves depends on the master processing, communication cycle, number of bytes transferred, and so on.

Also check the specification of a master together.

A master generates EtherCAT Network Information (ENI) (using a configuration tool) based on EtherCAT Slave Information (ESI) offered from our company, and builds an EtherCAT network using ENI.

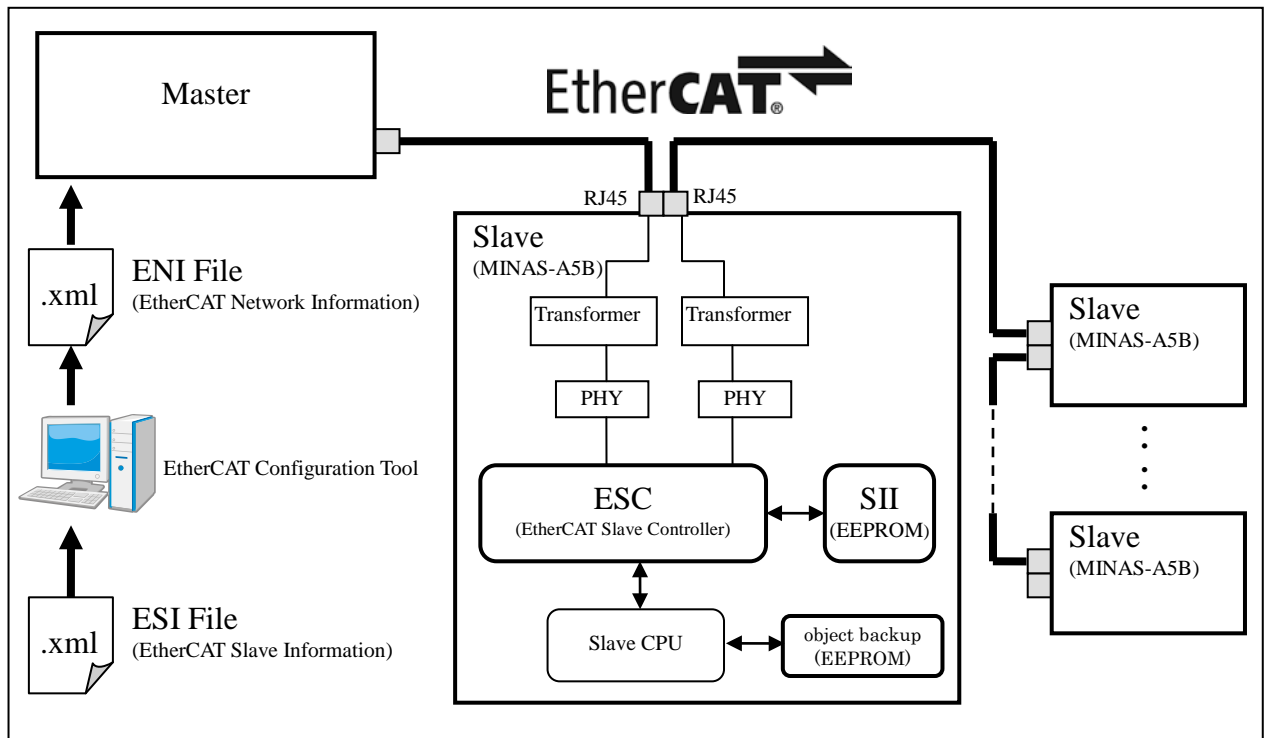

EtherCAT Slave Information (ESI) :

It is a file of the XML form offered from our company.

The definition of slave peculiar information (Vendor information, product information, a profile, an object, process data, the existence of a synchronization, a SyncManager setup, etc) is indicated.

EtherCAT Network Information (ENI) :

This is a file created by a master.

Information which identifies a slave (Vendor information etc.) and information for initializing each slave is contained in ENI and a master performs network initialization and construction based on information indicated to ENI.

Slave Information Interface (SII) :

EEPROM which saved SII data is connected to ESC. The information on Initialization information of ESC, Spec value of communication settings of the slave application (Data value size of the mailbox), Mapping of process data, etc. is set up into this EEPROM (SII).

Note:

- The length of the cable between nodes should be up to 100 m.
- Be aware that EtherCAT cannot connect to other than EtherCAT communication type, the MINAS-A4N and MINAS-A5N series for example as the RTEX (Realtime Express) communication type.

2-4 Specification List

Item	Specification																						
Physical layer	100BASE-TX (IEEE802.3)																						
Baud rate	100[Mbps] (Full duplex)																						
Topology	Line																						
Connection cable	Twist pair CAT5e																						
Cable length	Between nodes: up to 100 m																						
Number of slaves (shafts) connected	Up to 65535																						
Communication port	2 ports (RJ45 connector)																						
EtherCAT Indicators (LED)	[RUN] RUN Indicator (Green) [ERR] ERROR Indicator (Red) [L/A IN] Port0 Link/Activity Indicator (Green) [L/A OUT] Port1 Link/Activity Indicator (Green)																						
Station Alias (ID)	Range: 0 to 65535 <Setting 1>: Lower 8 bits: 2-digit rotary switch (front panel) Upper 8 bits: Object 3740h or <Setting 2>: SII saving value																						
Explicit Device ID	Supported																						
Device profile	CoE (CANopen over EtherCAT)																						
SyncManager	4																						
FMMU	3																						
Modes of Operation (operation mode) Abbreviation: Op-mode	<table border="1"> <thead> <tr> <th>Servo loop</th> <th colspan="2">Modes of operation</th> </tr> </thead> <tbody> <tr> <td rowspan="4">Position</td> <td>pp</td> <td>Profile position mode</td> </tr> <tr> <td>csp</td> <td>Cyclic synchronous position mode</td> </tr> <tr> <td>ip (Not supported)</td> <td>Interpolate position mode</td> </tr> <tr> <td>hm</td> <td>Homing mode</td> </tr> <tr> <td rowspan="2">Velocity</td> <td>pv</td> <td>Profile velocity mode</td> </tr> <tr> <td>csv</td> <td>Cyclic synchronous velocity mode</td> </tr> <tr> <td rowspan="2">Torque</td> <td>tq</td> <td>Torque profile mode</td> </tr> <tr> <td>cst</td> <td>Cyclic synchronous torque mode</td> </tr> </tbody> </table>	Servo loop	Modes of operation		Position	pp	Profile position mode	csp	Cyclic synchronous position mode	ip (Not supported)	Interpolate position mode	hm	Homing mode	Velocity	pv	Profile velocity mode	csv	Cyclic synchronous velocity mode	Torque	tq	Torque profile mode	cst	Cyclic synchronous torque mode
Servo loop	Modes of operation																						
Position	pp	Profile position mode																					
	csp	Cyclic synchronous position mode																					
	ip (Not supported)	Interpolate position mode																					
	hm	Homing mode																					
Velocity	pv	Profile velocity mode																					
	csv	Cyclic synchronous velocity mode																					
Torque	tq	Torque profile mode																					
	cst	Cyclic synchronous torque mode																					
Touch Probe	2ch Positive edge/Negative edge																						
Synchronous mode	DC (SYNC0 event synchronization) (DC 32bit) SM2 (SM2 event synchronization) Free RUN (asynchronous)																						
Cycle time (DC, SM2 communication cycle)	250, 500, 1000, 2000, 4000[μs]																						
Communication object	SDO (Service Data Object) PDO (Process Data Object)																						
SDO message	Supported: SDO Request, SDO Response, SDO information, Emergency Message Not supported: Complete Access																						
Free PDO Mapping	Supported																						
Maximum number of PDO assigns	RxPDO:4 [Table] TxPDO:4 [Table]																						
Maximum PDO data length	RxPDO:32 [byte] TxPDO:32 [byte]																						
Diagnosis Object	Diagnosis message only																						
Command Object	Not supported																						
Shift time	It only supports Input(Response) in increments of 250us.																						
Communication error correction of csp	Supported																						
Object Monitor	Supported (Object values can be monitored using the setup support software PANATERM)																						

3 EtherCAT Communication Specification

3-1 EtherCAT Frame Configuration.....	13
3-2 ESM (EtherCAT State Machine)	15
3-3 ESC Address Space.....	17
3-4 SII (Slave Information Interface) EEPROM	19
3-4-1 SII Area (0000h to 003Fh).....	20
3-5 Synchronous Communication Mode.....	22
3-5-1 DC (synchronous with SYNC0 event).....	23
3-5-2 SM2 (synchronous with SM2 event)	24
3-5-3 Free RUN (asynchronous)	25
3-6 SDO (Service Data Object).....	26
1) Mailbox frame configuration	26
2) Mailbox timeout.....	27
3-6-1 Message at Error Occurrence.....	28
1) Abort Message	28
2) Emergency Message	29
3-7 PDO (Process Data Object).....	32
3-7-1 PDO Mapping Object	33
3-7-2 PDO Assign Object.....	34
3-8 Front Panel Configuration.....	35
3-8-1 EtherCAT Indicators.....	35
1) RUN.....	36
2) ERR.....	36
3) L/A IN.....	36
4) L/A OUT.....	36
3-8-2 Node addressing (Setting Station alias)	37
1) Reading the value of SII from Configured Station Alias	38
2) Reading the value of rotary switch from Configured Station Alias	38
3) Reading the value of rotary switch from AL Status Code (Explicit Device ID).....	39

3-1 EtherCAT Frame Configuration

EtherCAT is an Ethernet based, real-time controllable, communication protocol for industrial use. EtherCAT is an extension of IEEE 802.3 Ethernet standard, allowing you to transfer data in the standard Ethernet frame without changing its basic structure. Set Ether Type in the Ethernet header to 88A4h, and subsequent Ethernet data is handled as the EtherCAT frame. The EtherCAT frame is composed of a header and not less than one datagram. And, the EtherCAT datagram is further divided more pieces. ESC handles only the EtherCAT frame with EtherCAT header type = 1.

Ethernet/EtherCAT frame configuration

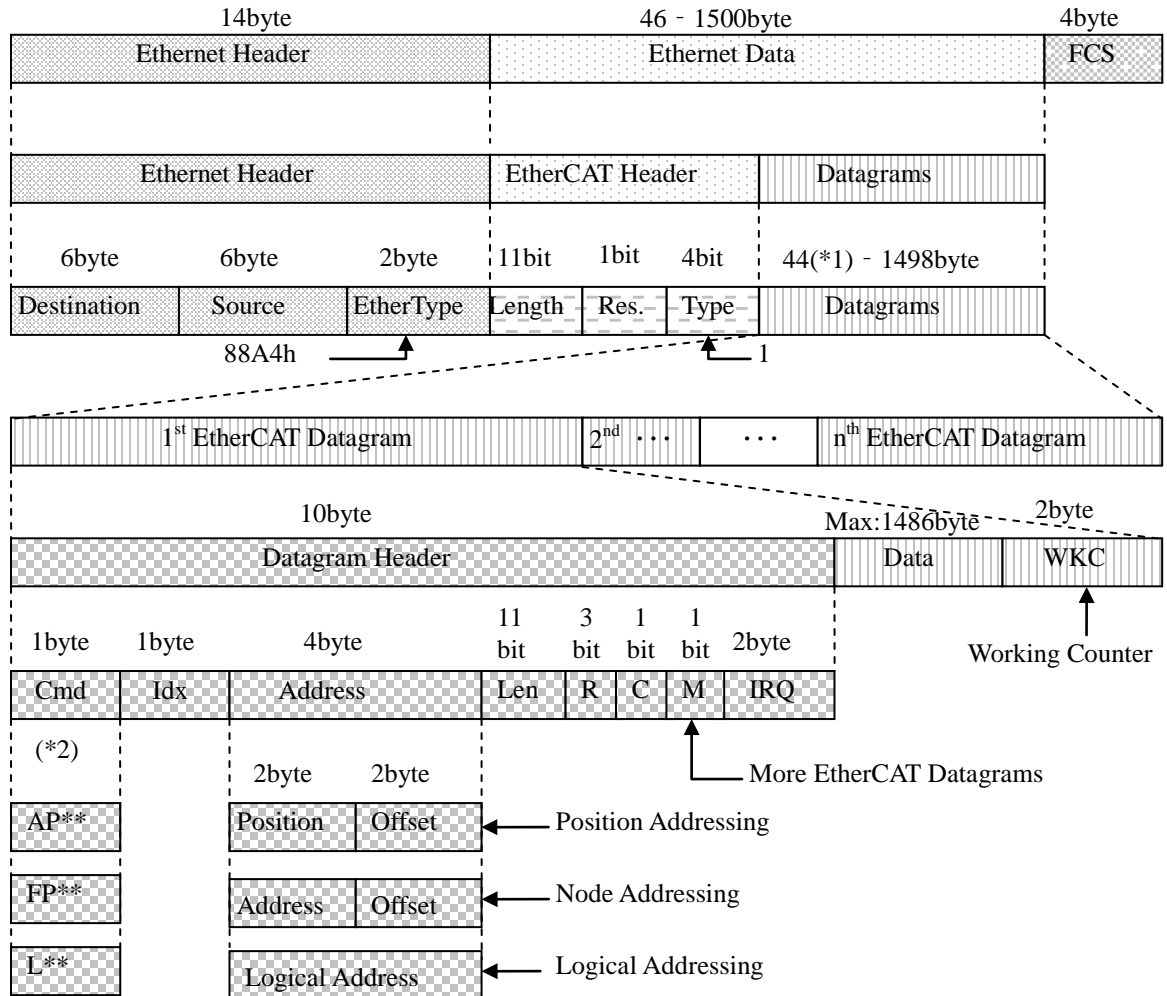

*1): If the Ethernet frame length is shorter than 64 bytes, add 1 to 32 bytes. (Ethernet Header + Ethernet Data + FCS)

*2) Cmd

Addressing mode	Cmd	Abbreviation	Name	Explanation
-	00h	NOP	No operation	No operation is executed.
Position Addressing	01h	APRD	Auto increment physical read	Each slave increments Address. When a frame whose Address value is 0 is received, the required read operation will be executed.
	02h	APWR	Auto increment physical write	Each slave increments Address. When a frame whose Address value is 0 is received, the required write operation will be executed.
	03h	APRW	Auto increment physical read write	Each slave increments Address. When a frame whose Address value is 0 is received, the required read & write operation will be executed.
Node Addressing	04h	FPRD	Configured address physical read	When the value of Address matches with Station Address, each slave executes the required read operation.
	05h	FPWR	Configured address physical write	When the value of Address matches with Station Address, each slave executes the required write operation.
	06h	FPRW	Configured address physical read write	When the value of Address matches with Station Address, each slave executes the required read & write operation.
—	07h	BRD	Broadcast read	All slaves execute the required read operation.
	08h	BWR	Broadcast write	All slaves execute the required write operation.
	09h	BRW	Broadcast read write	All slaves execute the required read & write operation.
Logical Addressing	0Ah	LRD	Logical read	When the value of Logical Address matches with the logical memory area designated by the request of FMMU, each slave executes the required read operation.
	0Bh	LWR	Logical write	When the value of Logical Address matches with the logical memory area designated by the request of FMMU, each slave executes the required write operation.
	0Ch	LRW	Logical read write	When the value of Logical Address matches with the logical memory area designated by the request of FMMU, each slave executes the required read & write operation.
Position Addressing	0Dh	ARWM	Positional physical read / multiple write	Each slave increments Address. A slave which received a frame whose Address value is 0 executes the required read operation. Other slaves execute the write operation.
Node Addressing	0Eh	FRMW	Configured address physical read / multiple write	Each slave compares the values of Address and Station Address. Matching slaves execute the required read operation. Other slaves execute the write operation.
—	0Fh ~ FFh	—	(Reserved)	—

3-2 ESM (EtherCAT State Machine)

The figure below shows a transition diagram for the state (ESM state) of EtherCAT application layer:

State transition diagram of EtherCAT application layer

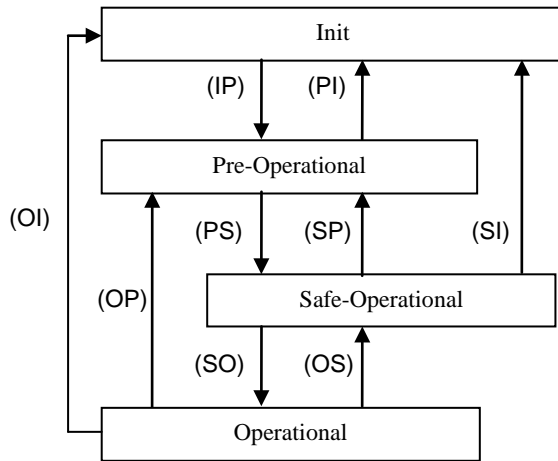

Note: The signs including IP are the abbreviations of the state transitions in the state transition diagram.

(IP):Init → Pre-Operational

(PS):Pre-Operational → Safe-Operational etc.

ESM state	Possible operation in each state	Communication operation			FFT test operation
		Send/receive SDO (Mailbox)	Send PDO (S to M)	Receive PDO (M to S)	
Init	The communication part is initializing and the transmission and reception with both SDO (Mailbox) and PDO are impossible	-	-	-	Yes
Pre-Operational (abbr.: PreOP)	Possible to send and receive data through SDO (Mailbox)	Yes	-	-	-
Safe-Operational (abbr.: SafeOP)	The transmission (from slave to master) with PDO as well as the transmission and reception over SDO (Mailbox) are possible	Yes	Yes	-	-
Operational (abbr.: OP)	Possible to send and receive both SDO (Mailbox) and PDO	Yes	Yes	Yes	-

- It is always possible to access an ESC register from the master regardless of the table above.
- When the command update, SYNC0 event, and SM2 event are stopped before the ESM state transition is completed while ESM is changing from Op to other ESM state (Init, PreOP, or SafeOP), a communication error may occur.
- A test run is possible in setup support soft PANATERM. To use a frequency characteristic measurement function, it is necessary to set an ESM state to Init.

The table below lists the relationship between each PDS (Power Drive Systems) and ESM states.
For more information on PDS (Power Drive Systems), refer to the section 6-2.

PDS state \ ESM state	Init	PreOP	SafeOP	Op
Not ready to switch on	Yes	No	No	Yes
Switch on disabled	Yes	Yes	Yes	Yes
Ready to switch on *1)	No	Yes	Yes	Yes
Switched on *1)	No	Yes	Yes	Yes
Operation enabled *2) *5)	No	Yes *4)	Yes *4)	Yes
Fault reaction active	Yes	Yes	Yes	Yes
Fault *3)	Yes	Yes	Yes	Yes

- *1): When the ESM state received a transition command from PreOp, SafeOp and Op to Init, the PDS state changes Switch on disabled.
- *2): When an ESM state received a transition command to other ESM states with the PDS state at "Operation enabled", Err.88.2 (ESM requirements during operation error protection) occurs and the PDS state changes to "Fault".
- *3): An ESM state is held when a PDS state changes to Fault by errors other than EtherCAT communication relation. However, an ESM state follows the specification indicated in Section 8-2 when EtherCAT communication relation error is occurred.
- *4): Transition to the Operation enable state PDS should be done at the time of the OP is ESM state.
- *5): It may take time for the state to complete a transition in accordance with an ESM request from the master; pay attention to the timeout setting on the master side and other relevant settings.
For example, if the ESM state is changed from "OP" to "PreOP" with the PDS state at "Operation enabled", Err.88.2 (ESM requirements during operation error protection) occurs, and deceleration is performed in accordance with 605Eh (Fault reaction option code). However, since the ESM state maintains "OP", the lower the deceleration rate, the longer it takes for the ESM state to transition to "PreOP".

3-3 ESC Address Space

MINAS-A5B has the physical address space of 12 Kbyte.

The first 4 Kbyte (0000h to 0FFFh) is used as a register space and subsequent 8 Kbyte is used as the process data RAM area.

Major registers are shown below. For details of the registers and other registers, refer to the datasheets of the IP cores (ET1815/ET1817).

ESC Register Byte Address	Length (Byte)	Description	Initial value *1)
ESC Information			
0000h	1	Type	04h
0001h	1	Revision	02h
0002h~0003h	2	Build	0040h
0004h	1	FMMUs supported	03h
0005h	1	SyncManagers supported	04h
0006h	1	RAM Size	08h
0007h	1	Port Descriptor	0Fh
0008h~0009h	2	ESC Features supported	0184h
Station Address			
0010h~0011h	2	Configured Station Address	-
0012h~0013h	2	Configured Station Alias	-
⋮			
Data Link Layer			
⋮			
0100h~0103h	4	ESC DL Control	-
⋮			
0110h~0111h	2	ESC DL Status	-
Application Layer			
0120h~0121h	2	AL Control	-
0130h~0131h	2	AL Status	-
0134h~0135h	2	AL Status Code	-
⋮			
PDI			
0140h	1	PDI Control	08h
0141h	1	ESC Configuration	0Ch
0150h	1	PDI Configuration	-
0151h	1	SYNC/LATCH PDI Configuration	66h
0152h~0153h	2	Extended PDI Configuration	-
⋮			

ESC Register Byte Address	Length (Byte)	Description	Initial value *1)
⋮			
Watchdogs			
0400h~0401h	2	Watchdog Divider	-
0410h~0411h	2	Watchdog Time PDI	-
0420h~0421h	2	Watchdog Time Process Data	-
0440h~0441h	2	Watchdog Status Process Data	-
0442h	1	Watchdog Counter Process Data	-
0443h	1	Watchdog Counter PDI	-
⋮			
FMMU			
0600h~062Fh	3x16	FMMU[2:0]	-
+0h~3h	4	Logical Start Address	-
+4h~5h	2	Length	-
+6h	1	Logical Start bit	-
+7h	1	Logical Stop bit	-
+8h~9h	2	Physical Start Address	-
+Ah	1	Physical Start bit	-
+Bh	1	Type	-
+Ch	1	Activate	-
+Dh~Fh	3	Reserved	-
⋮			
Distributed Clocks (DC) — SYNC Out Unit			
0981h	1	Activation	-
⋮			
0984h	1	Activation Status	-
098Eh	1	SYNC0 Status	-
⋮			
0990h~0993h	4	Start Time Cyclic Operation/Next SYNC0 Pulse	-
⋮			
09A0h~09A3h	4	SYNC0 Cycle Time	-
⋮			

*1) The initial value is at the time of start-up ESC. Thereafter, may change such as CPU firmware.

3-4 SII (Slave Information Interface) EEPROM

MINAS-A5B is equipped with 16 Kbit EEPROM for storing the EtherCAT slave information (ESI). The table below lists the EEPROM structure. ESI uses the word addressing.

SII EEPROM Word Address	+0h	+1h	+2h	+3h	+4h	+5h	+6h	+7h
0000h	EtherCAT Slave Controller Configuration Area							
0008h	Vendor ID		Product Code		Revision Number		Serial Number	
0010h	Hardware Delays				Bootstrap Mailbox Config			
0018h	Mailbox Sync Man Config							
0020h	Reserved							
⋮								
0038h							Size	Version
0040h	Additional Information (Subdivided in Categories)							
⋮	Category Strings							
	Category Generals							
	Category FMMU							
	Category SyncManager							
	Category TxPDO / RxPDO for each PDO							

3-4-1 SII Area (0000h to 003Fh)

Among the ESC configuration areas (EEPROM word address 0000h to 0007h), Configured Station Alias is automatically read out by ESC and written to the ESC register after the power is turned on.

To reflect the value after SII EEPROM change to the ESC register, turn off the power and then on again.

Except for this, the initial value of the IP core (ET1815/ET1817) is set.

Note: Basically, do not make changes to other addresses than 0004h (Configured Station Alias) and 0007h (Checksum). 0004h and 0007h need to be changed together. For details, refer to the datasheets of the IP cores (ET1815/ET1817).

SII EEPROM Word Address	Name	Description	ESC Register Word Address	Data type	Initial value
0000h	PDI Control	Initial value for the PDI control register	0140h 0141h	Unsigned16	0C08h
0001h	PDI Configuration	Initial value for the PDI configuration register	0150h 0151h	Unsigned16	6600h
0002h	Pulse Length of SYNC Signals	Initial value for the pulse length of SYNC signal	0982h 0983h	Unsigned16	0064h
0003h	Extended PDI Configuration	Initial value for the extended PDI configuration register	0152h 0153h	Unsigned16	0002h
0004h	Configured Station Alias	Initial value for the Station Alias (ID) For details, refer to section 3-8-2.	0012h 0013h	Unsigned16	0000h
0005h	Reserved	Reserved	-	BYTE[4]	-
0006h					
0007h	Checksum	Checksum of ESC configuration area	-	Unsigned16	-

The table below lists the contents of SII EEPROM following the ESC configuration area:

SII EEPROM Word Address	Name	Description	ESC Register Word Address	Data type	Initial value
0008h	Vendor ID	Vendor ID	-	Unsigned32	066Fh
0009h					
000Ah	Product Code	Product code	-	Unsigned32	(Depends on the product)
000Bh					
000Ch	Revision Number	Revision No	-	Unsigned32	(Depends on the product)
000Dh					
000Eh	Serial Number	Serial No	-	Unsigned32	(Depends on the product)
000Fh					
0010h	Execution Delay	Execution delay	-	Unsigned16	0000h
0011h	Port0 Delay	Port 0 delay	-	Int16	0000h
0012h	Port1 Delay	Port 1 delay	-	Int16	0000h
0013h	Reserved	Reserved	-	BYTE[2]	-
0014h	Bootstrap Receive Mailbox Offset	Offset (from master to slave) of receiving Mailbox in Bootstrap state (Not supported)	-	Unsigned16	0000h
0015h	Bootstrap Receive Mailbox Size	Size (from master to slave) of receiving Mailbox in Bootstrap state (Not supported)	-	Unsigned16	0000h
0016h	Bootstrap Send Mailbox Offset	Offset (from slave to master) of sending Mailbox in Bootstrap state (Not supported)	-	Unsigned16	0000h
0017h	Bootstrap Send Mailbox Size	Size (from slave to master) of sending Mailbox in Bootstrap state (Not supported)	-	Unsigned16	0000h
0018h	Standard Receive Mailbox Offset	Offset (from master to slave) of default receiving Mailbox	-	Unsigned16	1000h
0019h	Standard Receive Mailbox Size	Size (from master to slave) of default receiving Mailbox	-	Unsigned16	0100h
001Ah	Standard Send Mailbox Offset	Offset (from slave to master) of default sending Mailbox	-	Unsigned16	1200h
001Bh	Standard Send Mailbox Size	Size (from slave to master) of default sending Mailbox	-	Unsigned16	0100h
001Ch	Mailbox Protocol	Supported Mailbox protocol	-	Unsigned16	0004h
001Dh	Reserved	Reserved	-	BYTE[66]	-
:					
003Dh					
003Eh	Size	Size of EEPROM (This amplifier is equipped with 16 Kbit EEPROM.)	-	Unsigned16	000Fh
003Fh	Version	Version (Fixed at 1.)	-	Unsigned16	0001h
0040h	Data for each category				
:					

3-5 Synchronous Communication Mode

The MINAS-A5B series enables you to select synchronous modes below:

Synchronous mode	Description	Synchronization method	Characteristic
DC	Synchronous with SYNC0 event	Synchronize the time information of other slaves based on the time of the first shaft.	<ul style="list-style-type: none"> •High accuracy •Correction process is required on the master side.
SM2	Synchronous with SM2 event	Synchronize it to the reception timing of RxPDO.	<ul style="list-style-type: none"> •There is no transmission delay correction and accuracy is low. •It is necessary to keep the transmission timing constant on the controller side. (dedicated hardware etc.)
FreeRun	Asynchronous	Asynchronous	<ul style="list-style-type: none"> •Process is simple. •Real-time characteristics are insufficient.

3-5-1 DC (synchronous with SYNC0 event)

The MINAS-A5B series is equipped with 32 bits DC (Distributed Clock).

The synchronization of the EtherCAT communication is based on DC.

A slave can be synchronized by sharing the same standard clock (System Time) based on DC.

The local cycle of the slave is triggered by the SYNC0 event.

The process (servo process) of the slave is triggered by the SYNC0 event cycle, so a slave process is always synchronous with the SYNC0 event.

The master needs to perform propagation delay compensation (offset compensation) at the time of communication initialization, and also needs to perform drift compensation periodically.

The figure below shows the flow from the control power-on to the synchronization between the SYNC0 event and slave process (servo process):

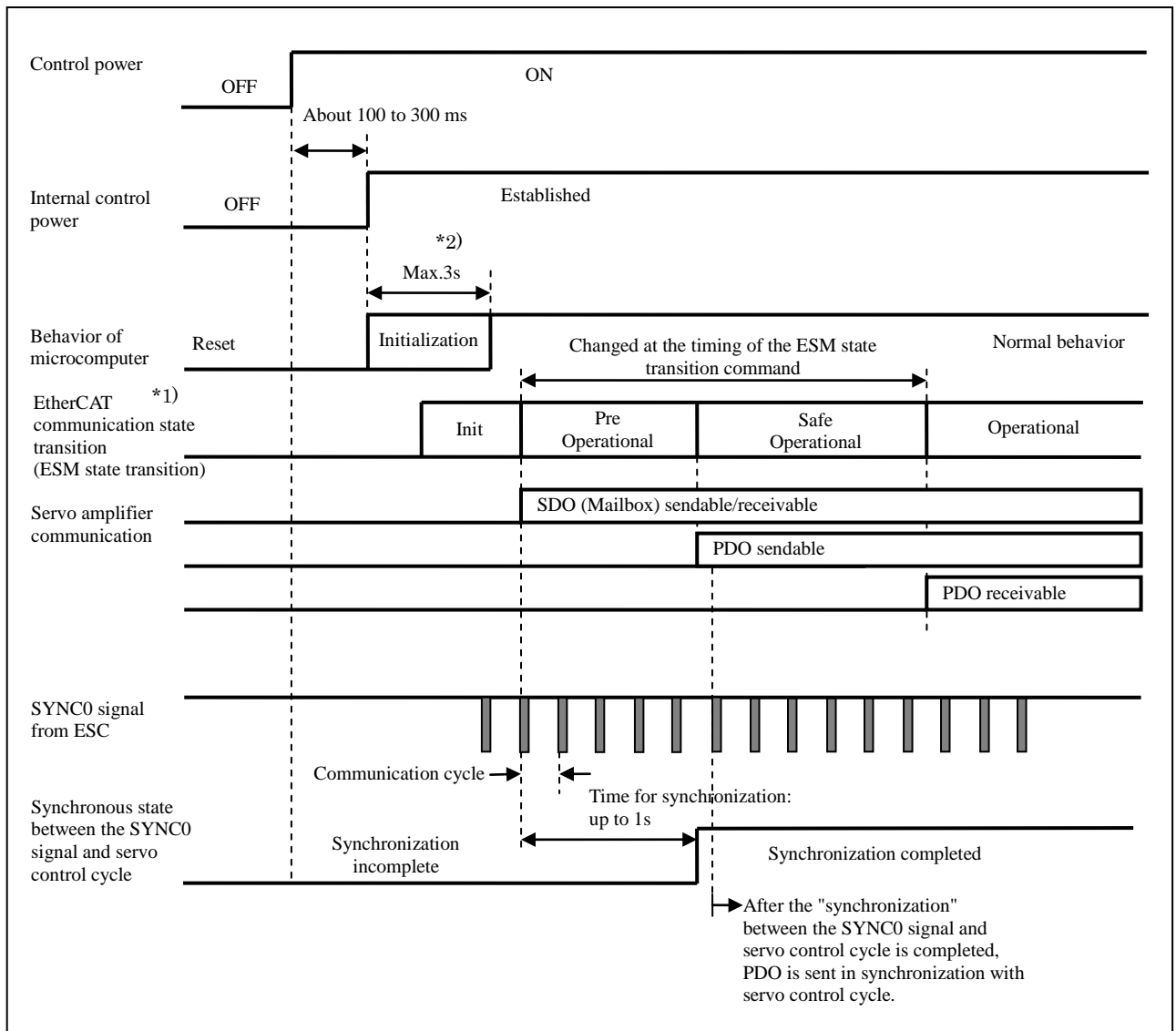

*1) The ESM state of the above figure is an internal state of servo amplifier. Check the completion of changes between each state by the higher rank (master) side.

*2) Initialization time can be lengthened at 3618h (Power-up wait time).

3-5-2 SM2 (synchronous with SM2 event)

Local cycle of the slave is triggered by the SM2 event.

The process of the slave is triggered by the SM2 event cycle, so slave process is always synchronous with the SM2 event.

Note: Since the SM2 event occurs in sync with the PDO reception, it is necessary to keep the sending timing of the upper (master) side constant.
 If the jitter (dispersion) of sending timing is large, the synchronization will not be completed or an alarm may occur.
 If it will cause a problem, use DC (synchronous with SYNC0 event).

The figure below shows the flow from the control power-on to the synchronization between the SM2 event and slave process (servo process):

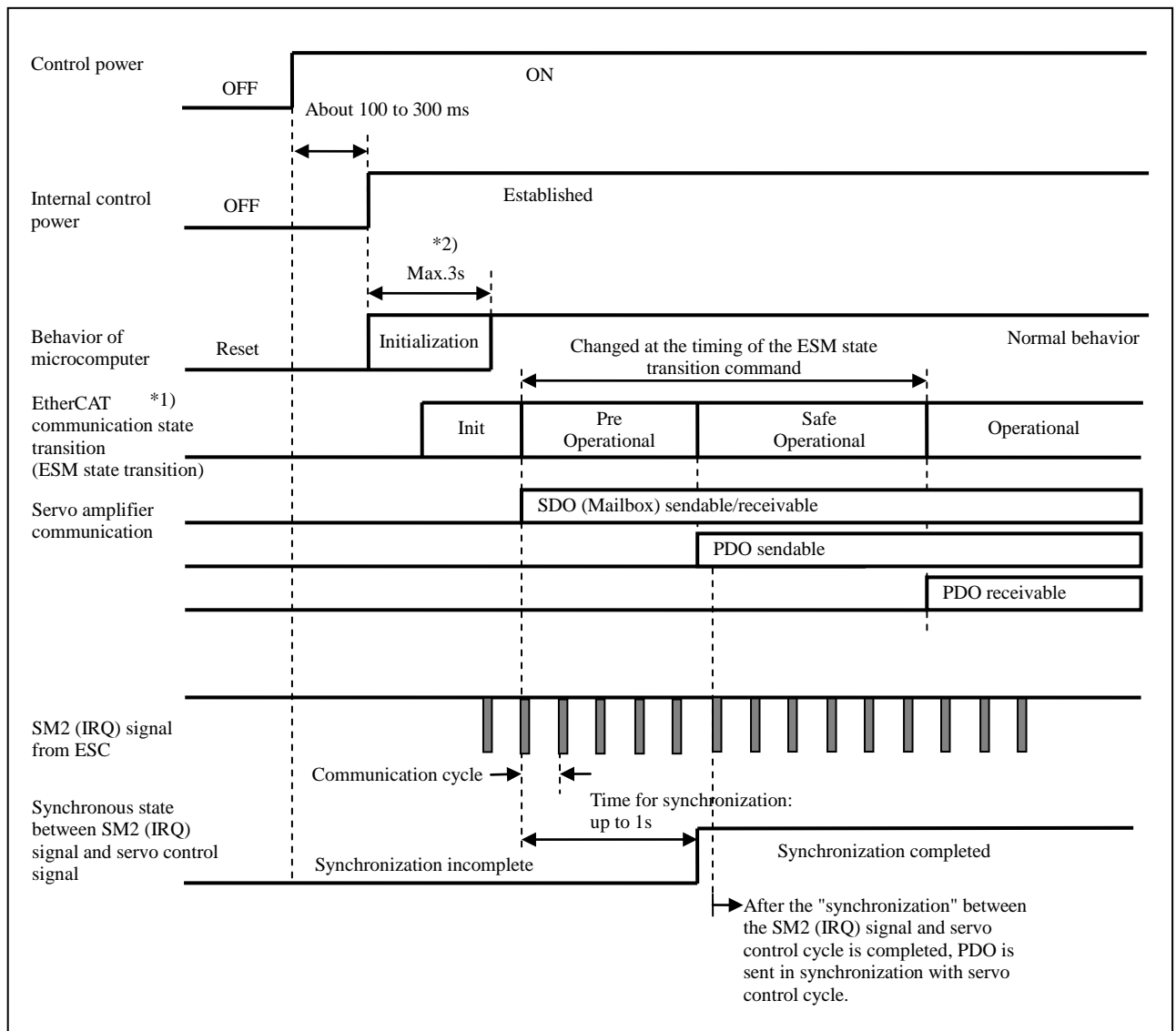

*1) The ESM state of the above figure is an internal state of servo amplifier. Check the completion of changes between each state by the higher rank (master) side.

*2) Initialization time can be lengthened at 3618h (Power-up wait time).

3-5-3 Free RUN (asynchronous)

The Free RUN mode is started by the local timer interrupt of a slave.

The local cycle runs independent of the communication cycle and master cycle and is asynchronous from them.

The figure below shows the flow during the control power-on:

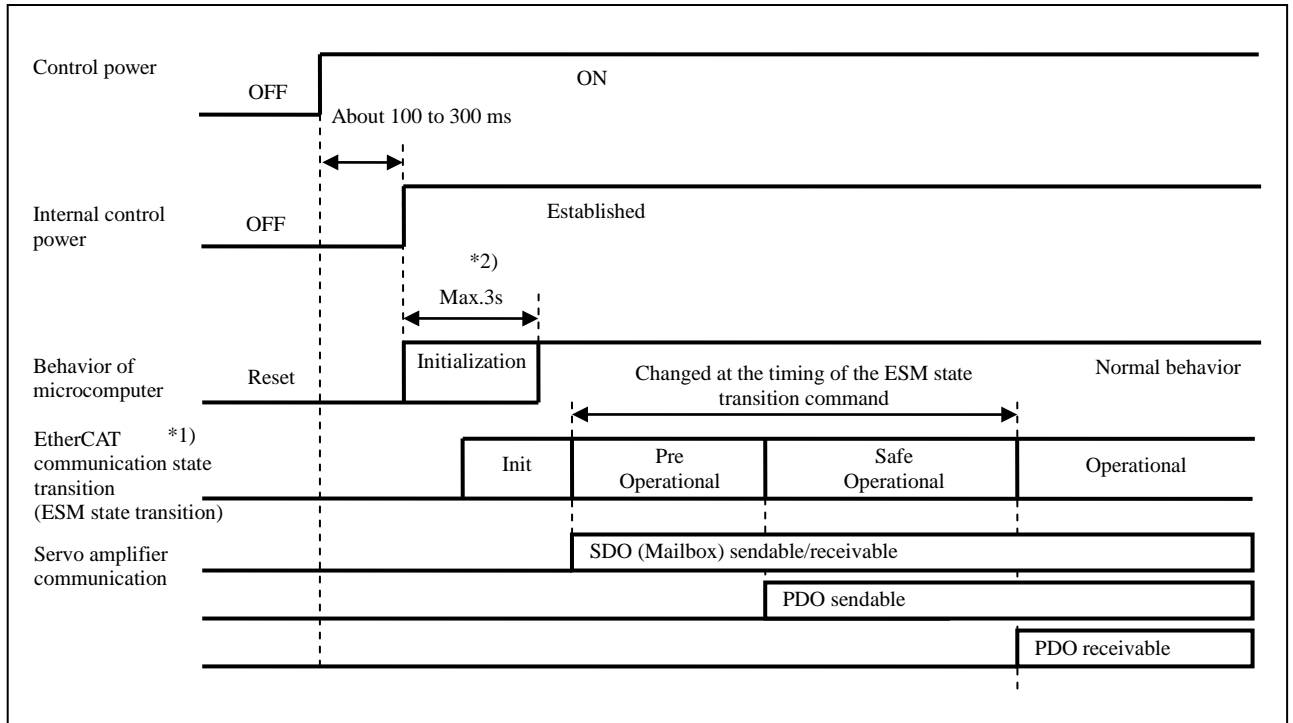

*1) The ESM state of the above figure is an internal state of servo amplifier. Check the completion of changes between each state by the higher rank (master) side.

*2) Initialization time can be lengthened at 3618h (Power-up wait time).

*3) Do not send PDO with a shorter cycle than 250 μs.

3-6 SDO (Service Data Object)

The MINAS-A5B series supports SDO (Services Data Object).

The data exchange of SDO uses the Mailbox communication. Therefore, be aware that the data update timing of the SDO will be indefinite.

The object setting and various state monitoring of the slaves are enabled by reading/writing data from/into the entry of the object dictionary in the master.

Note)

- It may take some time to read and write operations SDO response.
- Objects that are updated in the PDO do not update the SDO.
They are overwritten with the values of PDO.

1) Mailbox frame configuration

The figure below shows the frame configuration of Mailbox/SDO.

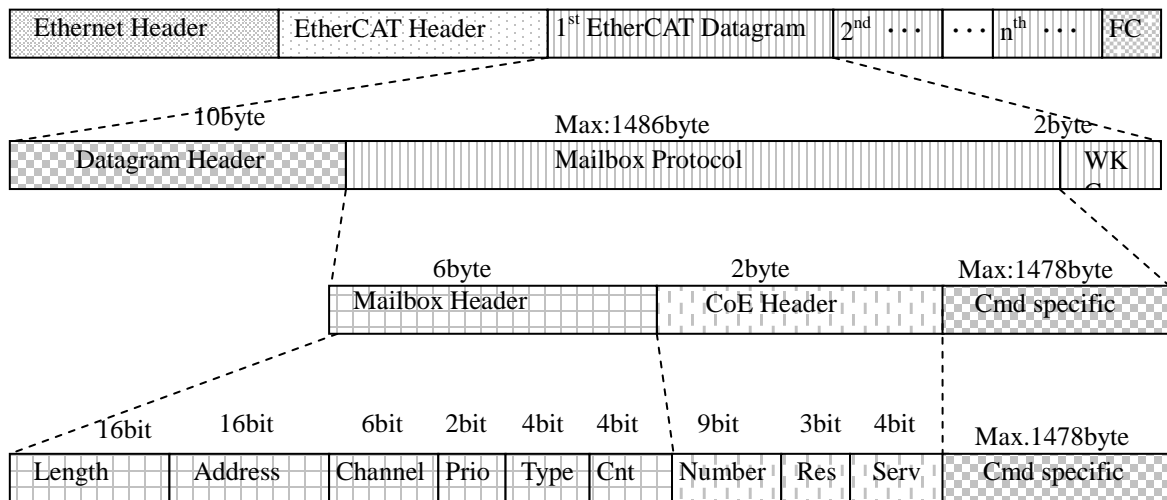

For more information, refer to ETG standards (ETG1000-5 and ETG1000-6).



Frame block	Data field	Data type	Function
Mailbox Header	Length	WORD	Data length of mailbox
	Address	WORD	Source station address
	Channel	Unsigned6	(Reserved)
	Priority	Unsigned2	Priority
	Type	Unsigned4	Mailbox type 00h : Error 01h : (Reserved) 02h : EoE (Not supported) 03h : CoE 04h : FoE (Not supported) 05h : SoE (Not supported) 06h-0Eh : (Reserved) 0Fh : VoE (Not supported)
	Cnt	Unsigned3	Mailbox counter
	Reserved	Unsigned1	(Reserved)
CoE Header	Number	Unsigned9	(Reserved)
	Reserved	Unsigned3	(Reserved)
	Service	Unsigned4	Message type
Cmd specific	Size indicator	Unsigned1	Dataset size enabled
	Transfer type	Unsigned1	Select Normal/Expedited transfer
	Dataset size	Unsigned2	Dataset size setting
	Complete access	Unsigned1	Select how to access object (Not supported)
	Command specifier	Unsigned3	Upload/download Select request, response, etc.
	Index	WORD	Object index
	Subindex	BYTE	Object sub-index
	□□□	□□□	Data, abort message, etc. of object [Function varies depending on the combination of the following: Size Indicator, Transfer Type, Data Set Size, Complete Access, Command Specifier]

2) Mailbox timeout

With this servo amplifier, the timeout time in Mailbox communication is set as follows:

-  - Timeout time for Mailbox request: 100 ms
If the master transmits a request to the slave (amplifier) and WKC of transmission data of the request frame is updated, the request is considered to be properly received by the slave.
Although retry operation is performed until WKC is updated, timeout occurs at the master side if WKC is not updated until this setting time expires.
-  - Timeout time for Mailbox response: 10 seconds
If the master receives a response to a request from the slave (amplifier) and WKC is updated, the response is considered to be properly received by the slave.
Timeout occurs at the master side if the master does not receive a response where WKC is updated until this setting time expires.
The maximum time required for the response creation of the slave (amplifier).

3-6-1 Message at Error Occurrence

1) Abort Message

When the SDO data exchange (read/write) fails, The error message containing Abort code, called Abort message is returned.

The abort message is an error only for the SDO data exchange. There is not any abort message for the PDO data exchange.

The contents of abort code can differ according to the access conditions.

Abort code	Description	
05030000h	Toggle bit not changed	(Not supported)
05040000h	SDO protocol timeout	(Not supported)
05040001h	Client/Server command specifier not valid or unknown	
05040005h	Out of memory	(Not supported)
06010000h	Not supported access to an object	
06010001h	Attempt to read to a write only object	(Not supported)
06010002h	Attempt to write to a read only object	
06010003h	Subindex cannot be written, SIO must be 0 for write access	
06020000h	The object does not exist in the object directory	
06040041h	The object can not be mapped into the PDO	(Not supported)
06040042h	The number and length of the objects to be mapped would exceed the PDO length	(Not supported)
06040043h	General parameter incompatibility reason	(Not supported)
06040047h	General internal incompatibility in the device	(Not supported)
06060000h	Access failed due to a hardware error	
06070010h	Data type does not match, length of service parameter does not match	
06070012h	Data type does not match, length of service parameter too high	(Not supported)
06070013h	Data type does not match, length of service parameter too low	(Not supported)
06090011h	Subindex does not exist	
06090030h	Value range of parameter exceeded (only for write access)	
06090031h	Value of parameter written too high	
06090032h	Value of parameter written too low	
06090036h	Maximum value is less than minimum value	
08000000h	General error	(Not supported)
08000020h	Data cannot be transferred or stored the application	
08000021h	Data cannot be transferred or stored to the application because of local control	(Not supported)
08000022h	Data cannot be transferred or stored to the application because of the present device state	
08000023h	Object dictionary dynamic generation fails or no object dictionary is present	

2) Emergency Message

A slave notifies the master of the emergency message through the mailbox communication when an error(alarm) occurs in the servo amplifier(Slave).

When no error (alarm) occurs and only warning occurs, it is not reported.



A maximum of 8 Emergency messages generated while the ESM state is Init are buffered in the order of occurrence, these messages are returned if the ESM state is PreOP or higher. However, if the number of Emergency messages exceeds 8, messages are discarded in the order of occurrence.

Effective/invalidity of Emergency message transmission can be set up by 10F3h(Diagnosis history)-05h(Flags):Bit0.

Emergency message transmission of a default is "effective". (10F3h-05h(Flags):Bit0=1)

Refer to Section 5-7 for Sub-Index other than Sub-Index:05h.

Index	Sub-Index	Name / Description	Units	Range	Data Type	Access	PDO	Op-mode	EEPROM	
10F3h	-	Diagnosis history Reads an error history and enables/disables an emergency message.	-	-	-	-	-	-	-	
	05h	Flags	-	0 - 65535	U16	See below	No	ALL	Yes	
		bit 0	RW	Emergency messages execution permission 0 : Emergency message Invalid 1 : Whenever new abnormality is detected, emergency message is issued. (Some of the anomaly does not remain in the Diagnosis message)						
		bit 1	R	Not supported : Fixed at 1						
		bit 2	R	Not supported : Fixed at 1						
		bit 3	R	Not supported : Fixed at 0						
		bit 4	R	Not supported : Fixed at 0						
		bit 5	R	Diagnosis message clearances information 1 : Clearance of diagnosis message is completed. (at the time of 10F3h-03h=0 writing) (The value is kept until new error (alarm) occurs)						
		bit 6-15	-	Reservation						



If an error(alarm) occurrence and clearing are repeated multiple times within a short period of time, only the emergency message for the final status may be noticed.

The emergency message is composed of 8 bytes data as shown in the figure below:

Byte	0	1	2	3	4	5	6	7
Description	Error code (*1) (OD:603Fh) (L) (H)		Error register (*2) (OD:1001h)	Error Field (*3) (L) (H)				

*1) Error code

The same value as 603Fh(Error code) returns to Error code.
 The error codes at 0000h to FEFFh are defined in IEC61800-7-201.
 FF00h to FFFFh is defined peculiar by the maker and serves as the following contents.

Index	Sub-Index	Name / Description	Units	Range	Data Type	Access	PDO	Op-mode	EEPRO M
603Fh	00h	Error code  <ul style="list-style-type: none"> Displays an alarm (main number only) / warning occurred in the servo amplifier. When both an alarm and warning does not occur, displays 0000h. When an alarm and warning occur at the same time, display the alarm. FF**h  Alarm (main) number (00h to 9Fh) warning number(A0h to A9h, C3h) Example: FF0Ch: 0Ch=12d. Err12.0 (over voltage protection) occurred FF55h: 55h=85d. Err85.0 (TxPDO assignment error protection) or Err85.1 (RxPDO assignment error protection) occurred (Note) In the case of Err81.7(SyncManager2/3 error protection) occurs, A000h is displayed as an exception.	-	0 - 65535	U16	ro	TxPDO	ALL	No

*2) Error register

The same value as the one in 1001h (Error register) is returned.

Index	Sub-Index	Name / Description	Units	Range	Data Type	Access	PDO	Op-mode	EEPRO M															
1001h	00h	Error Register Displays the type (state) of an alarm occurred in the servo amplifier. When an alarm does not occur, displays 0000h. No warning is displayed. <table border="1" data-bbox="510 1456 1380 1758"> <thead> <tr> <th>bit</th> <th>Description</th> </tr> </thead> <tbody> <tr> <td>0</td> <td rowspan="3">(Not supported)</td> </tr> <tr> <td>1</td> </tr> <tr> <td>2</td> </tr> <tr> <td>3</td> <td rowspan="2">The alarm which is defined in the AL status code *1)</td> </tr> <tr> <td>4</td> </tr> <tr> <td>5</td> <td>(Not supported)</td> </tr> <tr> <td>6</td> <td>(reserved)</td> </tr> <tr> <td>7</td> <td>The alarm which is not defined in AL status code *2)</td> </tr> </tbody> </table> <p>*1) " The alarm which is defined in the AL status code " is which indicate Err80.0-7 and Err81.0-7, Err85.0-7 in the EtherCAT communication related error. *2) " The alarm which is not defined in AL status code " is which indicate Err88.0-7 in the EtherCAT communication related error and other than EhterCAT communication related error. The details of alarm refer to Chapter 8.</p>	bit	Description	0	(Not supported)	1	2	3	The alarm which is defined in the AL status code *1)	4	5	(Not supported)	6	(reserved)	7	The alarm which is not defined in AL status code *2)	-	0 - 255	U8	ro	No	ALL	No
bit	Description																							
0	(Not supported)																							
1																								
2																								
3	The alarm which is defined in the AL status code *1)																							
4																								
5	(Not supported)																							
6	(reserved)																							
7	The alarm which is not defined in AL status code *2)																							

*3) Error Field

- When abnormalities other than Err81.7(SyncManager2/3 error protection) occur within servo amplifier:
The alarm's subnumber is returned to Data [0].
00h is returned to Data [1] to [4].

Example: Err.16.1 (Torque saturation protection) occurred:

Byte	0	1	2	3	4	5	6	7
Description	Error code		Error register	Data [0]	Data [1]	Data [2]	Data [3]	Data [4]
Value	FF10h		80h	01h	00h	00h	00h	00h

↑ Alarm main number ↑ Alarm sub number

- When an abnormal condition is cleared in the servo amplifier:
Data [0] to [4] is 00h cleared.

Example: The alarm state is cleared due to the fault reset:

Byte	0	1	2	3	4	5	6	7
Description	Error code		Error register	Data [0]	Data [1]	Data [2]	Data [3]	Data [4]
Value	0000h		00h	00h	00h	00h	00h	00h

- The SM2/3 setting check at the time of the changes to SafeOp from PreOp is inaccurate in the communication error, and when Err81.7 “SyncManager2/3 error protection” occurs, Error code is set to A000h, Error register is set to 10h, and it returns regular data.
For more information, refer to ETG standards (ETG1000-6).

Example:

- [1] The Length(ESC Register 0812h and 0813h) of SyncManager2 is invalid *1)
- [2] The Physical Start Address(ESC Register 0810h and 0811h) of SyncManager2 is invalid (other than 1000h to 2FFFh, odd, etc.)
- [3] The SyncManager2 setting is invalid (set to Inactive, 1buffer, Write, etc.)
- [4] The Length(ESC Register 081Ah and 081Bh) of SyncManager3 is invalid *1)
- [5] The Physical Start Address(ESC Register 0818h and 0819h) of SyncManager3 is invalid (other than 1000h to 2FFFh, odd, etc.)
- [6] The SyncManager3 setting is invalid (set to Inactive, 1buffer, Read, etc.)

Byte	0	1	2	3	4	5	6	7
Description	Error code		Error register	Data [0]	Data [1]	Data [2]	Data [3]	Data [4]
[1]	A000h		10h	08h	(L) Length *2)	(H)	(L) Length *2)	(H)
[2]	A000h		10h	09h	00h	10h	FEh	2Fh
[3]	A000h		10h	0Ah	24h *3)	00h *3)	01h *3)	00h *3)
[4]	A000h		10h	0Ch	(L) Length *2)	(H)	(L) Length *2)	(H)
[5]	A000h		10h	0Dh	00h	10h	FEh	2Fh
[6]	A000h		10h	0Eh	22h *3)	03h *3)	01h *3)	00h *3)

- *1) It returns, when the setting is different from the PDO mapping size.
If the PDO mapping size exceeds 32 bytes, Err85.1(RxPDO assignment error protection) occurs, and 01h (the subnumber of the alarm) is returned to Data [0], and 00h is returned to Data [1] to [4].
- *2) An actual set value of the PDO mapping size is returned to Length.
For example, when the PDO mapping size is 9, returned values are: Data [1] = 09h, Data [2] = 00h, Data [3] = 09h, and Data [4] = 00h.
- *3) When the PDO mapping size is 0, 00h is returned to Data [1] to [4].

3-7 PDO (Process Data Object)

The MINAS-A5B series supports PDO (Process Data Object).

The real time data transfer over EtherCAT is done by the data exchange with PDO (Process Data Object).

PDO is composed of RxPDO transferring from master to slave and TxPDO transferring from slave to master.

	Sender	Receiver
RxPDO	Master	Slave
TxPDO	Slave	Master

(Note) The object updated by PDO should not carry out updating by SDO.

3-7-1 PDO Mapping Object

The PDO mapping is the mapping of the application object from the object dictionary to PDO.
 As the PDO mapping table, MINAS-A5B can use the mapping object from 1600h to 1603h for RxPDO and from 1A00h to 1A03h for TxPDO.

The maximum number of application objects to be mapped to a mapping object is as follows:

Maximum PDO data length	RxPDO:32 [byte] TxPDO:32 [byte]
-------------------------	------------------------------------

Here, setting example of the PDO mapping is as follows:
 For more information on setting method, refer to section 5-4.

<Setting example>

In the case set application object(6040h,6060h,607Ah,60B8h) to 1600h(Receive PDO mapping 1:RxPDO_1).

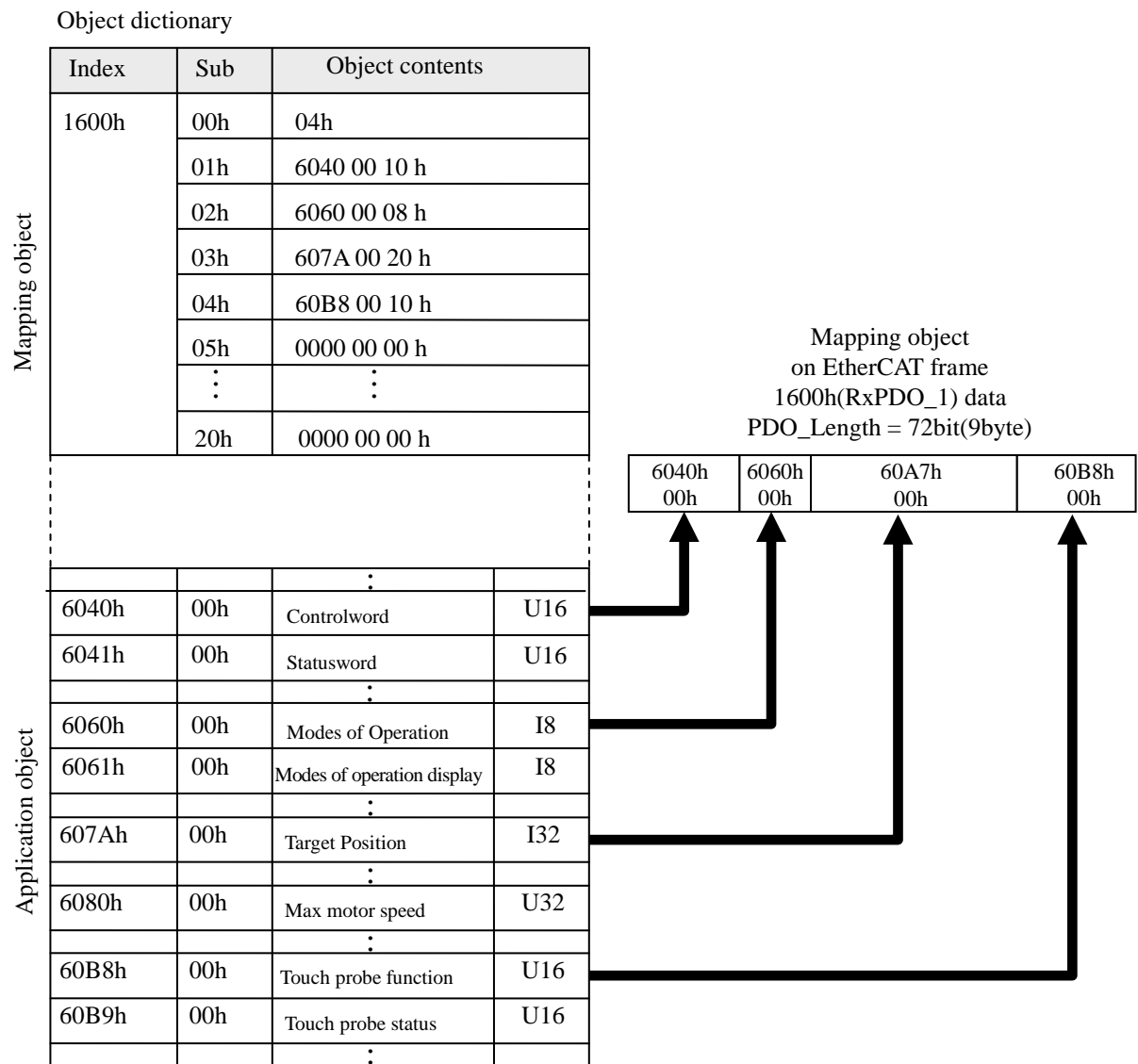

3-7-2 PDO Assign Object

To exchange the PDO data, assign a PDO mapping table in Sync Manager.

Describe the relationship between PDO mapping table and Sync Manager in the Sync Manager PDO assign object.

MINAS-A5B can use 1C12h for RxPDO (SyncManager2) and 1C13h for TxPDO (SyncManager3), as a Sync Manager PDO assign object.

The maximum number of mapping objects to be mapped to an assign object is as follows:

Maximum number of PDO assigns	RxPDO:4 [Table] TxPDO:4 [Table]
-------------------------------	------------------------------------

Normally, only one mapping object is sufficient, so a change from default is not required.

The setting example of the Sync Manager PDO assign object is as follows:

For more information on setting method, refer to section 5-4.

<Setting example>

In the case set 1A00h(Transmit PDO mapping 1:TxPDO_1) to assign object 1C13h(Sync manager channel 3).

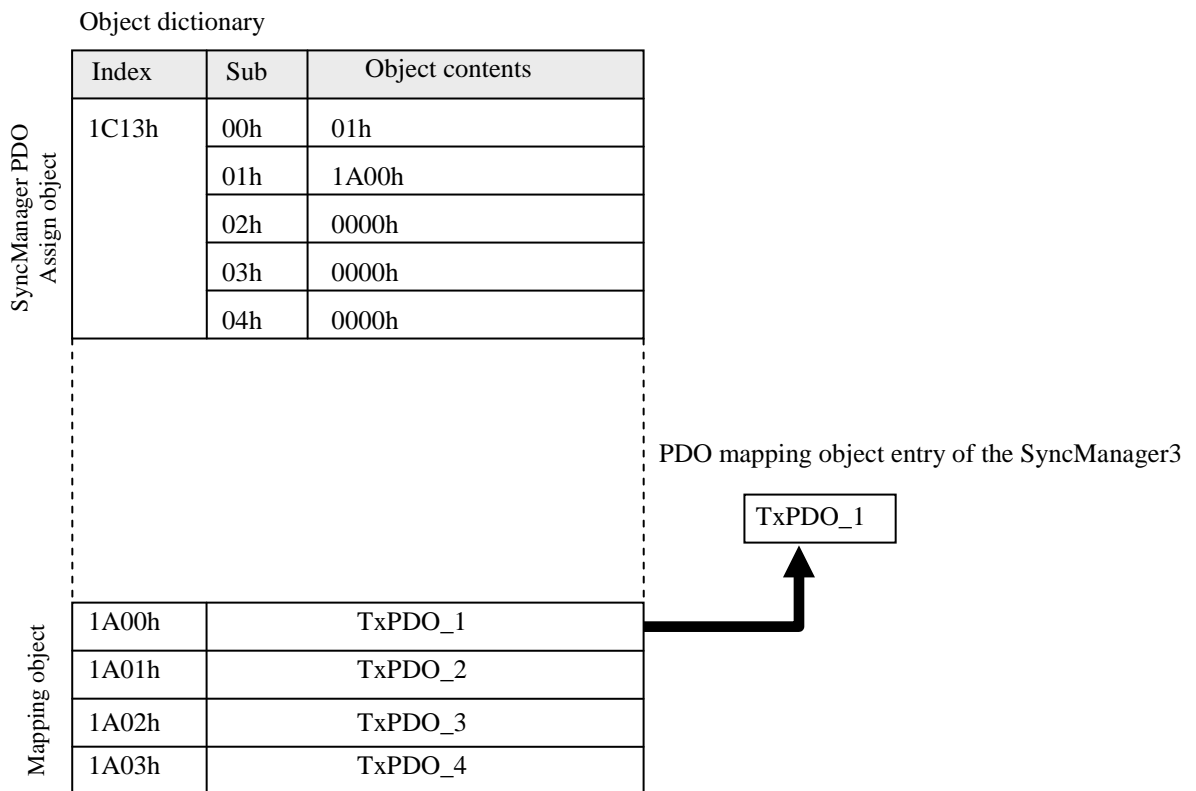

3-8 Front Panel Configuration

The figure below shows the front panel configuration in the MINAS-A5B series:

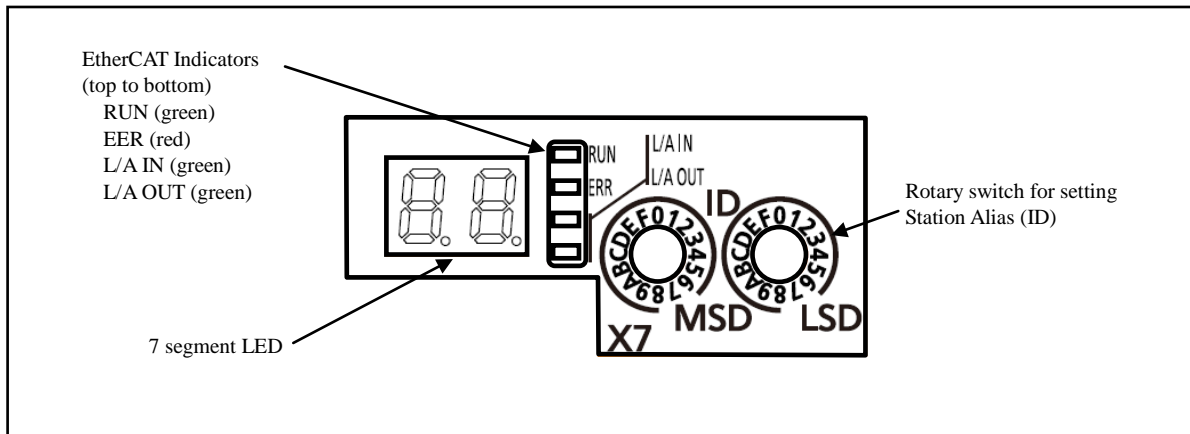

3-8-1 EtherCAT Indicators

MINAS-A5B series has four EtherCAT Indicators (LED).

There are four patterns below indicating the LED status besides ON and OFF:

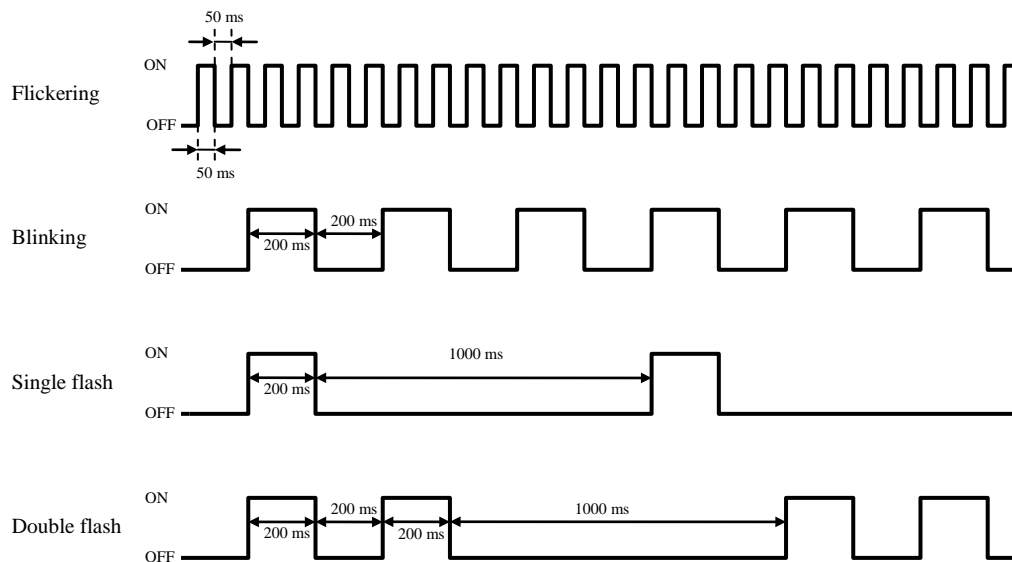

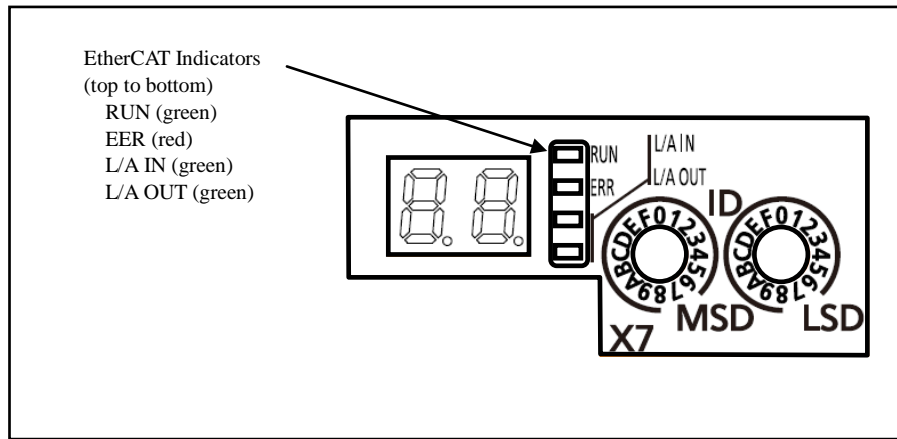

1) RUN

RUN Indicator indicates the ESM (EtherCAT State Machine) status.

LED lights in green.

LED state	Description
OFF	ESM: INIT state
Blinking	ESM: Pre-operational state
Single flash	ESM: Safe-operational state
ON	ESM: Operational state

2) ERR

ERR Indicator indicates an alarm state defined in the AL status code *1).

LED lights in red.

Also, For more information, refer to section 8-1.

LED state	Description
OFF	No occurrence of alarms defined in the AL status code *1)
Blinking	Communication setup error
Single flash	Synchronous event error
Double flash	Application watchdog timeout
Flickering	Initialization error
ON	PDI error

*1) Alarms defined in the AL status code refer to Err80.0 to 7, Err81.0 to 7, and Err85.0 to 7 of the errors related to EtherCAT communication.

3) L/A IN

4) L/A OUT

L/A IN, L/A OUT Indicators indicate the LINK state and activity of each port's physical layer.

LED lights in green.

LED state	Description
OFF	LINK not established
Flickering	LINK established, There are data transmission and reception.
ON	LINK established, There are no data transmission and reception.

3-8-2 Node addressing (Setting Station alias)

Addressing mode defined by EtherCAT is as follows.

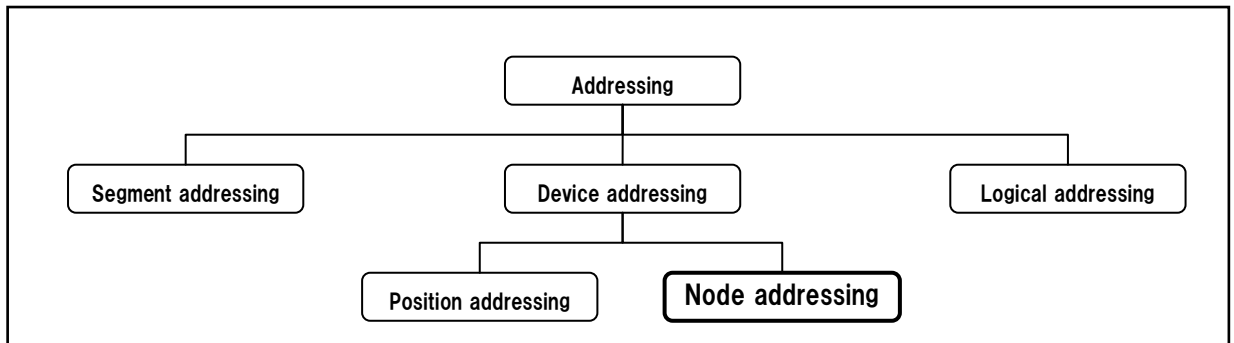

This section describes about the method of Node addressing.

This is peculiar node ID (Station alias) for a master to specify a slave.

In this servo amplifier, Node addressing has three ways regarding setting means and reading method.

- 1) Reading the value of SII from Configured Station Alias
 Reading the value of 0004h(Configured Station Alias) in the SII from 0012h(Configured Station Alias) of ESC register.
- 2) Reading the value of rotary switch from Configured Station Alias
 Reading the value made of object 3740h(Station alias setup(high)) and front panel rotary switch from 0012h(Configured Station Alias) of ESC register.
- 3) Reading the value of rotary switch from AL Status Code (Explicit Device ID)
 Reading the value made of object 3740h(Station alias setup(high)) and front panel rotary switch from AL Status Code(0134h).

The master reads the set values of the Configured Station Alias (0012h) of the ESC register and sets them to the Configured Station Address (0010h).

Thereby addresses such as FPRD commands used in the mailbox are set.

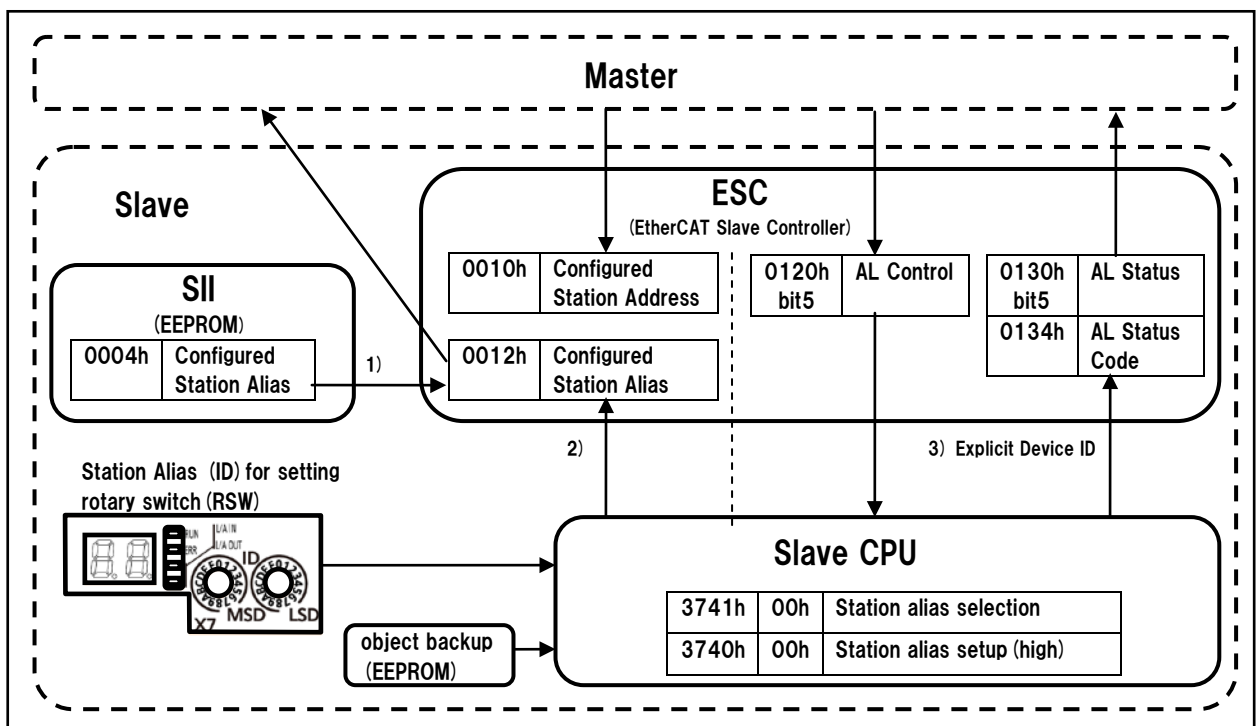

1) Reading the value of SII from Configured Station Alias

This explains the method of reading the value of 0004h(Configured Station Alias) in the SII from 0012h(Configured Station Alias) of ESC register.

Servo amplifier reads the value of object 3741h(Station alias selection) from backup EEPROM at the control power-on.

If the value is 1, the value saved at 0004h(Configured Station Alias) in the SII into 0012h(Configured Station Alias) of ESC register.

Master reads this value.

2) Reading the value of rotary switch from Configured Station Alias

This explains the method of reading the value made of object 3740h(Station alias setup(high)) and front panel rotary switch from 0012h(Configured Station Alias) of ESC register.

Servo amplifier reads the value of object 3741h(Station alias selection) from backup EEPROM at the control power-on.

If the value is 0, the value made of object 3740h(Station alias setup(high)) and front panel rotary switch into 0012h(Configured Station Alias) of ESC register.

Master reads this value.

- Selection of station alias setting

Index	Sub-Index	Name / Description	Units	Range	Data Type	Access	PDO	Op-mode	EEPROM									
3741h	00h	Station Alias selection Designates how to set a Station Alias. * Default configuration is 1.	-	0 - 2	Int16	rw	No	ALL	Yes									
		<table border="1"> <thead> <tr> <th>value</th> <th>Function</th> </tr> </thead> <tbody> <tr> <td>0</td> <td>The value made of object 3740h and front panel rotary switch is set as station alias. *1)</td> </tr> <tr> <td>1</td> <td>The value saved at 0004h in the SII is set as station alias.</td> </tr> <tr> <td>2</td> <td>Used by manufacturer (Can not be set)</td> </tr> </tbody> </table>	value	Function	0	The value made of object 3740h and front panel rotary switch is set as station alias. *1)	1	The value saved at 0004h in the SII is set as station alias.	2	Used by manufacturer (Can not be set)								
value	Function																	
0	The value made of object 3740h and front panel rotary switch is set as station alias. *1)																	
1	The value saved at 0004h in the SII is set as station alias.																	
2	Used by manufacturer (Can not be set)																	
		*1) If setting values for both the rotary switch and 3740h are 0, the value of the SII area (0004h) is regarded as Station Alias.																

- How to set the parameters with rotary switch and object

The Station Alias is set by combining a value (lower 8 bits) set by rotary switch and a value (upper 8 bits) in 3740h (Station Alias setup (high)).

Station Alias	
Upper 8 bits	Lower 8 bits
Value set by 3740h	Value set by rotary switch

Index	Sub-Index	Name / Description	Units	Range	Data Type	Access	PDO	Op-mode	EEPROM
3740h	00h	Station Alias setup(high) Designates upper 8 bits of the Station Alias.	-	0 - 255	Int16	rw	No	ALL	Yes

Note: Each setting is enabled when the control power is turned on.

Therefore, if a value is changed after control power-on, the change is not yet effective.

Note that the change will be effective at next control power-on.

To avoid unnecessary problem, do not alter each value after control power-on.

3) Reading the value of rotary switch from AL Status Code (Explicit Device ID)

This explains the method of reading the value made of object 3740h(Station alias setup(high))(upper 8 bits) and front panel rotary switch(lower 8 bits) from AL Status Code(0134h).

The Station Alias read by this method is not that of 0012h (Configured Station Alias) of an ESC register.

- (1) Bit5 (ID Request) of AL Control(0120h) is set to 1.
- (2) The Station Alias set up by a rotary switch (lower 8 bits) and 3740h(upper 8 bits) returns to AL Status Code(0134h).
- (3) 1 returns to Bit5 (ID Loaded) of AL Status(0130h).
- (4) Bit5 (ID Request) of AL Control(0120h) is set to 0.
- (5) 0 returns to Bit5 (ID Loaded) of AL Status(0130h).
- (6) AL Status Code(0134h) is cleared.

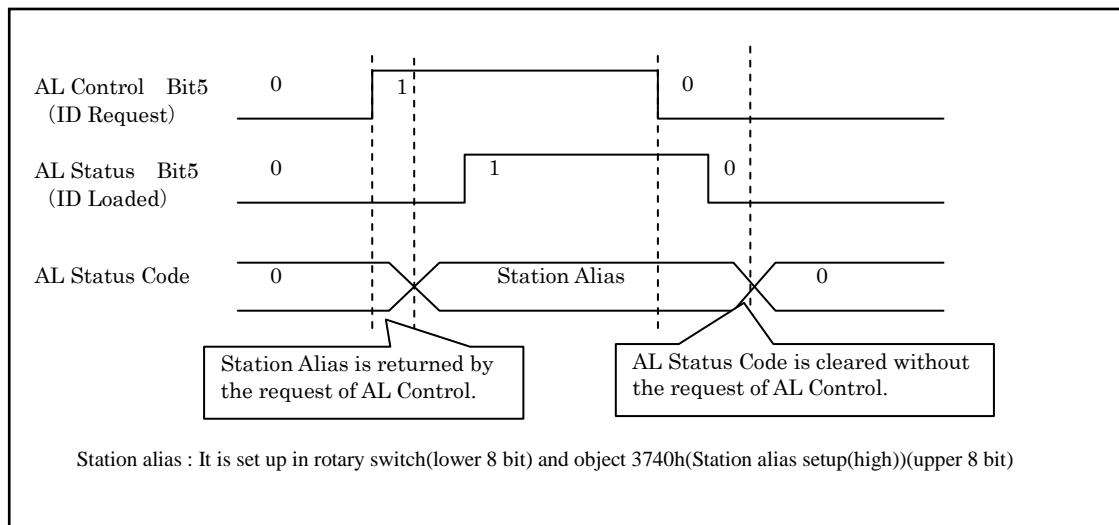

In the period of returning Station Alias, if a alarm which is defined in the AL status code(Err80.0-7, Err81.0-7 and Err85.0-7 in the EtherCAT communication related errors) occurs, AL status code of the alarm is returned.

When the alarm is cleared, Station Alias is returned again.

(To clear alarm, refer to Section 8-4)

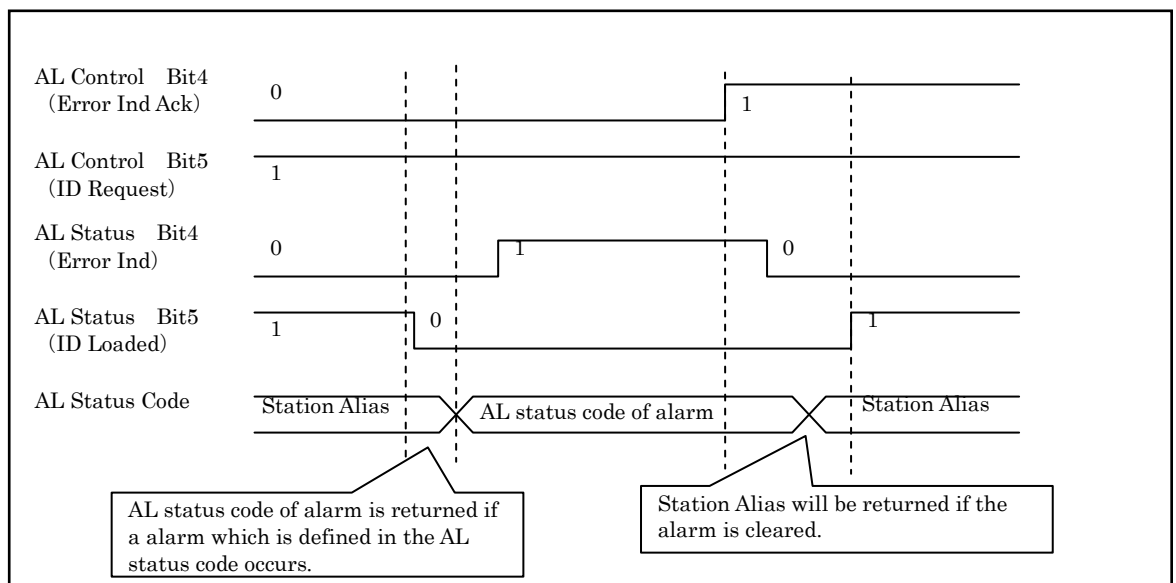

4 Common Object Specification

4-1 Object Configuration..... 41

4-1 Object Configuration

Every object is addressed by 16 bits index which is represented as a 4-digit hexadecimal number and is placed in an object dictionary on an object group basis.

The table below lists the CoE (CANopen over EtherCAT) object dictionary defined in CiA402 and the MINAS-A5B series object dictionary.

Object dictionary defined in CiA402		MINAS-A5B object dictionary		
Index	Description	Index	Description	Refer to
0000h to 0FFFh	Data type area	0000h to 0FFFh	Data type area	-
1000h to 1FFFh	CoE communication area	1000h to 1FFFh	CoE communication area	Chapter 5
2000h to 5FFFh	Manufacturer-specific area	2000h to 2FFFh	Reserved	-
		3000h to 3FFFh	Servo parameter area	Chapter 7
		4000h to 5FFFh	Reserved	-
6000h to 9FFFh	Profile area	6000h to 6FFFh	Drive profile area	Chapter 6
		7000h to 9FFFh	Reserved	-
A000h to FFFFh	Reserved	A000h to FFFFh	Reserved	-

5 CoE Communication Area (1000h to 1FFFh)

5-1 Object List.....	43
5-2 Device Information	45
5-3 Sync Manager Communication Type (1C00h).....	47
5-4 PDO (Process Data Object) Mapping	48
5-4-1 PDO Assign Object (1C12h to 1C13h).....	48
5-4-2 PDO Mapping Object (1600h to 1603h, 1A00h to 1A03h)	49
5-4-3 Default PDO Mapping	51
5-4-4 PDO Mapping Setting Procedure.....	53
5-5 Sync Manager 2/3 Synchronization (1C32h, 1C33h).....	55
5-5-1 DC (synchronous with SYNC0 event).....	59
5-5-2 SM2 (synchronous with SM2 event)	61
5-5-3 Free RUN (asynchronous)	63
5-5-4 Input shift time.....	65
5-6 Store Parameters (write object in EEPROM) (1010h)	66
5-7 Diagnosis history (Reading Function of Error (alarm) History) (10F3h).....	67

5-1 Object List

Index	Sub-Index	Name
1000h	00h	Device type
1001h	00h	Error register
1008h	00h	Manufacturer device name
1009h	00h	Manufacturer hardware version
100Ah	00h	Manufacturer software version
1010h		Store parameters
	00h	Number of entries
	01h	Save all parameters
1018h		Identity object
	00h	Number of entries
	01h	Vendor ID
	02h	Product code
	03h	Revision number
10F3h		Diagnosis history
	00h	Number of entries
	01h	Maximum messages
	02h	Newest message
	03h	Newest acknowledged message
	04h	New messages available
	05h	Flags
	06h	Diagnosis message 1
	∴	∴
	13h	Diagnosis message 14

Index	Sub-Index	Name
1600h		Receive PDO mapping 1
	00h	Number of entries
	01h	1st receive PDO mapped
	02h	2nd receive PDO mapped
	03h	3rd receive PDO mapped
	04h	4th receive PDO mapped
	05h	5th receive PDO mapped
	06h	6th receive PDO mapped
	07h	7th receive PDO mapped
	08h	8th receive PDO mapped
	∴	∴
	20h	32nd receive PDO mapped
	1601h	
00h		Number of entries
01h		1st receive PDO mapped
02h		2nd receive PDO mapped
03h		3rd receive PDO mapped
04h		4th receive PDO mapped
05h		5th receive PDO mapped
06h		6th receive PDO mapped
07h		7th receive PDO mapped
08h		8th receive PDO mapped
∴		∴
20h		32nd receive PDO mapped
1602h		
	00h	Number of entries
	01h	1st receive PDO mapped
	02h	2nd receive PDO mapped
	03h	3rd receive PDO mapped
	04h	4th receive PDO mapped
	05h	5th receive PDO mapped
	06h	6th receive PDO mapped
	07h	7th receive PDO mapped
	08h	8th receive PDO mapped
	∴	∴
	20h	32nd receive PDO mapped
	1603h	
00h		Number of entries
01h		1st receive PDO mapped
02h		2nd receive PDO mapped
03h		3rd receive PDO mapped
04h		4th receive PDO mapped
05h		5th receive PDO mapped
06h		6th receive PDO mapped
07h		7th receive PDO mapped
08h		8th receive PDO mapped
∴		∴
20h		32nd receive PDO mapped

Index	Sub-Index	Name
1A00h		Transmit PDO mapping 1
	00h	Number of entries
	01h	1st transmit PDO mapped
	02h	2nd transmit PDO mapped
	03h	3rd transmit PDO mapped
	04h	4th transmit PDO mapped
	05h	5th transmit PDO mapped
	06h	6th transmit PDO mapped
	07h	7th transmit PDO mapped
	08h	8th transmit PDO mapped
	∴	∴
1A01h	20h	32nd transmit PDO mapped
		Transmit PDO mapping 2
	00h	Number of entries
	01h	1st transmit PDO mapped
	02h	2nd transmit PDO mapped
	03h	3rd transmit PDO mapped
	04h	4th transmit PDO mapped
	05h	5th transmit PDO mapped
	06h	6th transmit PDO mapped
	07h	7th transmit PDO mapped
	08h	8th transmit PDO mapped
∴	∴	
1A02h	20h	32nd transmit PDO mapped
		Transmit PDO mapping 3
	00h	Number of entries
	01h	1st transmit PDO mapped
	02h	2nd transmit PDO mapped
	03h	3rd transmit PDO mapped
	04h	4th transmit PDO mapped
	05h	5th transmit PDO mapped
	06h	6th transmit PDO mapped
	07h	7th transmit PDO mapped
	08h	8th transmit PDO mapped
∴	∴	
1A03h	20h	32nd transmit PDO mapped
		Transmit PDO mapping 4
	00h	Number of entries
	01h	1st transmit PDO mapped
	02h	2nd transmit PDO mapped
	03h	3rd transmit PDO mapped
	04h	4th transmit PDO mapped
	05h	5th transmit PDO mapped
	06h	6th transmit PDO mapped
	07h	7th transmit PDO mapped
	08h	8th transmit PDO mapped
∴	∴	
1C00h	20h	32nd transmit PDO mapped
		Sync manager communication type
	00h	Number of used sync manager channels
	01h	Communication type sync manager 0
	02h	Communication type sync manager 1
03h	Communication type sync manager 2	
04h	Communication type sync manager 3	

Index	Sub-Index	Name
1C12h		Sync manager channel 2
	00h	Number of assigned PDOs
	01h	PDO mapping object index of assigned RxPDO 1
	02h	PDO mapping object index of assigned RxPDO 2
	03h	PDO mapping object index of assigned RxPDO 3
1C13h	04h	PDO mapping object index of assigned RxPDO 4
		Sync manager channel 3
	00h	Number of assigned PDOs
	01h	PDO mapping object index of assigned TxPDO 1
	02h	PDO mapping object index of assigned TxPDO 2
1C32h	03h	PDO mapping object index of assigned TxPDO 3
	04h	PDO mapping object index of assigned TxPDO 4
		Sync manager 2 synchronization
	00h	Number of sub-objects
	01h	Sync mode
1C33h	02h	Cycle time
	03h	Shift time
	04h	Sync modes supported
	05h	Minimum cycle time
	06h	Calc and copy time
	08h	Command
	09h	Delay time
	0Ah	Sync0 cycle time
	0Bh	Cycle time too small
	0Ch	SM-event missed
	0Dh	Shift time too short
	0Eh	RxPDO toggle failed
	20h	Sync error
1C33h		Sync manager 3 synchronization
	00h	Number of sub-objects
	01h	Sync mode
	02h	Cycle time
	03h	Shift time
	04h	Sync modes supported
	05h	Minimum cycle time
	06h	Calc and copy time
	08h	Command
	09h	Delay time
	0Ah	Sync0 cycle time
	0Bh	Cycle time too small
	0Ch	SM-event missed
0Dh	Shift time too short	
0Eh	RxPDO toggle failed	
20h	Sync error	

5-2 Device Information

This section describes the objects for the device information of slaves.

Index	Sub-Index	Name / Description	Units	Range	Data Type	Access	PDO	Op-mode	EEPROM																																																		
1000h	00h	Device type • Displays a device type. The value of the servo amplifier is fixed at 00020192h.	-	0 - 4294967295	U32	ro	No	ALL	No																																																		
1001h	00h	Error register Displays the type (state) of an alarm occurred in the servo amplifier. When an alarm does not occur, displays 0000h. No warning is displayed.	-	0 - 255	U8	ro	No	ALL	No																																																		
		<table border="1"> <thead> <tr> <th>bit</th> <th>Description</th> </tr> </thead> <tbody> <tr> <td>0</td> <td rowspan="4">(Not supported)</td> </tr> <tr> <td>1</td> </tr> <tr> <td>2</td> </tr> <tr> <td>3</td> </tr> <tr> <td>4</td> <td>The alarm which is defined in the AL status code *1)</td> </tr> <tr> <td>5</td> <td>(Not supported)</td> </tr> <tr> <td>6</td> <td>(reserved)</td> </tr> <tr> <td>7</td> <td>The alarm which is not defined in AL status code *2)</td> </tr> </tbody> </table> <p>*1) " The alarm which is defined in the AL status code " indicate Err80.0-7 and Err81.0-7, Err85.0-7 in the EtherCAT communication related error. *2) " The alarm which is not defined in AL status code " indicate Err88.0-7 in the EtherCAT communication related error and other than EtherCAT communication related error.</p> <p>The details of alarm refer to Chapter 8.</p>	bit	Description	0	(Not supported)	1	2	3	4	The alarm which is defined in the AL status code *1)	5	(Not supported)	6	(reserved)	7	The alarm which is not defined in AL status code *2)																																										
bit	Description																																																										
0	(Not supported)																																																										
1																																																											
2																																																											
3																																																											
4	The alarm which is defined in the AL status code *1)																																																										
5	(Not supported)																																																										
6	(reserved)																																																										
7	The alarm which is not defined in AL status code *2)																																																										
1008h	00h	Manufacture device name Displays a product model with 16 characters. If it is less than 16 characters long, add spaces (20h). Example:	-	-	VS	ro	No	ALL	No																																																		
		<table border="1"> <thead> <tr> <th>byte</th> <th>0</th> <th>1</th> <th>2</th> <th>3</th> <th>4</th> <th>5</th> <th>6</th> <th>7</th> <th>8</th> <th>9</th> <th>10</th> <th>11</th> <th>12</th> <th>13</th> <th>14</th> <th>15</th> </tr> </thead> <tbody> <tr> <td>character</td> <td>M</td> <td>A</td> <td>D</td> <td>H</td> <td>T</td> <td>1</td> <td>5</td> <td>0</td> <td>5</td> <td>B</td> <td>A</td> <td>2</td> <td colspan="4">(space)</td> </tr> </tbody> </table>	byte	0	1	2	3	4	5	6	7	8	9	10	11	12	13	14	15	character	M	A	D	H	T	1	5	0	5	B	A	2	(space)																										
byte	0	1	2	3	4	5	6	7	8	9	10	11	12	13	14	15																																											
character	M	A	D	H	T	1	5	0	5	B	A	2	(space)																																														
1009h	00h	Manufacture hardware version Displays a product hardware version with 16 characters. If it is less than 16 characters long, add spaces (20h). Example: *Hardware version: 1.23:	-	-	VS	ro	No	ALL	No																																																		
		<table border="1"> <thead> <tr> <th>byte</th> <th>0</th> <th>1</th> <th>2</th> <th>3</th> <th>4</th> <th>5</th> <th>6</th> <th>7</th> <th>8</th> <th>9</th> <th>10</th> <th>11</th> <th>12</th> <th>13</th> <th>14</th> <th>15</th> </tr> </thead> <tbody> <tr> <td>character</td> <td>V</td> <td>1</td> <td>.</td> <td>2</td> <td>3</td> <td colspan="10">(space)</td> </tr> <tr> <td>Application</td> <td>(fixed)</td> <td colspan="4">Hardware version</td> <td colspan="11">(space)</td> </tr> </tbody> </table>	byte	0	1	2	3	4	5	6	7	8	9	10	11	12	13	14	15	character	V	1	.	2	3	(space)										Application	(fixed)	Hardware version				(space)																	
byte	0	1	2	3	4	5	6	7	8	9	10	11	12	13	14	15																																											
character	V	1	.	2	3	(space)																																																					
Application	(fixed)	Hardware version				(space)																																																					
100Ah	00h	Manufacturer software version Displays a product software version 3 with 16 characters. If it is less than 16 characters long, add spaces (20h). Example: *Software version3: 1.23:	-	-	VS	ro	No	ALL	No																																																		
		<table border="1"> <thead> <tr> <th>byte</th> <th>0</th> <th>1</th> <th>2</th> <th>3</th> <th>4</th> <th>5</th> <th>6</th> <th>7</th> <th>8</th> <th>9</th> <th>10</th> <th>11</th> <th>12</th> <th>13</th> <th>14</th> <th>15</th> </tr> </thead> <tbody> <tr> <td>character</td> <td>V</td> <td>1</td> <td>.</td> <td>2</td> <td>3</td> <td colspan="10">(space)</td> </tr> <tr> <td>Application</td> <td>(fixed)</td> <td colspan="4">Software version3</td> <td colspan="11">(space)</td> </tr> </tbody> </table>	byte	0	1	2	3	4	5	6	7	8	9	10	11	12	13	14	15	character	V	1	.	2	3	(space)										Application	(fixed)	Software version3				(space)																	
byte	0	1	2	3	4	5	6	7	8	9	10	11	12	13	14	15																																											
character	V	1	.	2	3	(space)																																																					
Application	(fixed)	Software version3				(space)																																																					

Index	Sub-Index	Name / Description	Units	Range	Data Type	Access	PDO	Op-mode	EEPROM																																																																																																																																																																									
1018h	-	Identity object Displays device information.	-	-	-	-	-	-	-																																																																																																																																																																									
	00h	Number of entries Represents the number of sub-indexes for this object. The value is fixed at 04h.	-	0 - 255	U8	ro	No	ALL	No																																																																																																																																																																									
	01h	Vendor ID Displays the EtherCAT Vender ID. The value is fixed at 66Fh.	-	0 - 4294967295	U32	ro	No	ALL	No																																																																																																																																																																									
	02h	Product code Displays a product code. Example) In case of the MADHT1505BA2 <table border="1" style="margin-left: 20px;"> <thead> <tr> <th>bit</th> <th>31-28</th> <th>27-24</th> <th>23-20</th> <th>19-16</th> <th>15-12</th> <th>11-8</th> <th>7-4</th> <th>3-0</th> </tr> </thead> <tbody> <tr> <td>value (hex)</td> <td>5</td> <td>1</td> <td>5</td> <td>0</td> <td>5</td> <td>0</td> <td>A</td> <td>2</td> </tr> <tr> <td>Application</td> <td>Series category *1)</td> <td colspan="4">6 to 9 figure of product form</td> <td colspan="2">11 figure of product form *2) *3)</td> <td colspan="2">12 figure of product form *3)</td> </tr> </tbody> </table> <p>*1) Contents to be displayed in each frame of A5 series is as follows.</p> <table border="1" style="margin-left: 20px;"> <thead> <tr> <th></th> <th colspan="2">bit 31-28</th> </tr> </thead> <tbody> <tr> <td>A5 series of frames A to G</td> <td colspan="2">5</td> </tr> <tr> <td>A5 series of frame H</td> <td colspan="2">D</td> </tr> </tbody> </table> <p>*2) Content to be displayed by the character of the 11 figure of product form will be as follows.</p> <table border="1" style="margin-left: 20px;"> <thead> <tr> <th></th> <th>bit 11-8</th> <th>bit 7-4</th> <th></th> <th>bit 11-8</th> <th>bit 7-4</th> <th></th> <th>bit 11-8</th> <th>bit 7-4</th> <th></th> <th>bit 11-8</th> <th>bit 7-4</th> </tr> </thead> <tbody> <tr> <td>0</td> <td>0</td> <td>0</td> <td>A</td> <td>0</td> <td>A</td> <td>K</td> <td>4</td> <td>4</td> <td>U</td> <td>4</td> <td>E</td> </tr> <tr> <td>1</td> <td>0</td> <td>1</td> <td>B</td> <td>0</td> <td>B</td> <td>L</td> <td>4</td> <td>5</td> <td>V</td> <td>4</td> <td>F</td> </tr> <tr> <td>2</td> <td>0</td> <td>2</td> <td>C</td> <td>0</td> <td>C</td> <td>M</td> <td>4</td> <td>6</td> <td>W</td> <td>8</td> <td>0</td> </tr> <tr> <td>3</td> <td>0</td> <td>3</td> <td>D</td> <td>0</td> <td>D</td> <td>N</td> <td>4</td> <td>7</td> <td>X</td> <td>8</td> <td>1</td> </tr> <tr> <td>4</td> <td>0</td> <td>4</td> <td>E</td> <td>0</td> <td>E</td> <td>O</td> <td>4</td> <td>8</td> <td>Y</td> <td>8</td> <td>2</td> </tr> <tr> <td>5</td> <td>0</td> <td>5</td> <td>F</td> <td>0</td> <td>F</td> <td>P</td> <td>4</td> <td>9</td> <td>Z</td> <td>8</td> <td>3</td> </tr> <tr> <td>6</td> <td>0</td> <td>6</td> <td>G</td> <td>4</td> <td>0</td> <td>Q</td> <td>4</td> <td>A</td> <td></td> <td></td> <td></td> </tr> <tr> <td>7</td> <td>0</td> <td>7</td> <td>H</td> <td>4</td> <td>1</td> <td>R</td> <td>4</td> <td>B</td> <td></td> <td></td> <td></td> </tr> <tr> <td>8</td> <td>0</td> <td>8</td> <td>I</td> <td>4</td> <td>2</td> <td>S</td> <td>4</td> <td>C</td> <td></td> <td></td> <td></td> </tr> <tr> <td>9</td> <td>0</td> <td>9</td> <td>J</td> <td>4</td> <td>3</td> <td>T</td> <td>4</td> <td>D</td> <td></td> <td></td> <td></td> </tr> </tbody> </table> <p>*3) The product from which the 12 figure of product form is set to "G"to"Z" in a special article etc. differs in the display method of bit11-0.</p>	bit	31-28	27-24	23-20	19-16	15-12	11-8	7-4	3-0	value (hex)	5	1	5	0	5	0	A	2	Application	Series category *1)	6 to 9 figure of product form				11 figure of product form *2) *3)		12 figure of product form *3)			bit 31-28		A5 series of frames A to G	5		A5 series of frame H	D			bit 11-8	bit 7-4		bit 11-8	bit 7-4		bit 11-8	bit 7-4		bit 11-8	bit 7-4	0	0	0	A	0	A	K	4	4	U	4	E	1	0	1	B	0	B	L	4	5	V	4	F	2	0	2	C	0	C	M	4	6	W	8	0	3	0	3	D	0	D	N	4	7	X	8	1	4	0	4	E	0	E	O	4	8	Y	8	2	5	0	5	F	0	F	P	4	9	Z	8	3	6	0	6	G	4	0	Q	4	A				7	0	7	H	4	1	R	4	B				8	0	8	I	4	2	S	4	C				9	0	9	J	4	3	T	4	D				-	0 - 4294967295	U32	ro	No	ALL	No
	bit	31-28	27-24	23-20	19-16	15-12	11-8	7-4	3-0																																																																																																																																																																									
value (hex)	5	1	5	0	5	0	A	2																																																																																																																																																																										
Application	Series category *1)	6 to 9 figure of product form				11 figure of product form *2) *3)		12 figure of product form *3)																																																																																																																																																																										
	bit 31-28																																																																																																																																																																																	
A5 series of frames A to G	5																																																																																																																																																																																	
A5 series of frame H	D																																																																																																																																																																																	
	bit 11-8	bit 7-4		bit 11-8	bit 7-4		bit 11-8	bit 7-4		bit 11-8	bit 7-4																																																																																																																																																																							
0	0	0	A	0	A	K	4	4	U	4	E																																																																																																																																																																							
1	0	1	B	0	B	L	4	5	V	4	F																																																																																																																																																																							
2	0	2	C	0	C	M	4	6	W	8	0																																																																																																																																																																							
3	0	3	D	0	D	N	4	7	X	8	1																																																																																																																																																																							
4	0	4	E	0	E	O	4	8	Y	8	2																																																																																																																																																																							
5	0	5	F	0	F	P	4	9	Z	8	3																																																																																																																																																																							
6	0	6	G	4	0	Q	4	A																																																																																																																																																																										
7	0	7	H	4	1	R	4	B																																																																																																																																																																										
8	0	8	I	4	2	S	4	C																																																																																																																																																																										
9	0	9	J	4	3	T	4	D																																																																																																																																																																										
03h	Revision number Displays a revision number. Example) In case of 1.23. <table border="1" style="margin-left: 20px;"> <thead> <tr> <th>bit</th> <th>31-28</th> <th>27-24</th> <th>23-20</th> <th>19-16</th> <th>15-12</th> <th>11-8</th> <th>7-4</th> <th>3-0</th> </tr> </thead> <tbody> <tr> <td>value (hex)</td> <td>0</td> <td>0</td> <td>0</td> <td>1</td> <td>0</td> <td>0</td> <td>2</td> <td>3</td> </tr> <tr> <td>Application</td> <td colspan="4">Major revision</td> <td colspan="4">Minor revision</td> </tr> </tbody> </table>	bit	31-28	27-24	23-20	19-16	15-12	11-8	7-4	3-0	value (hex)	0	0	0	1	0	0	2	3	Application	Major revision				Minor revision				-	0 - 4294967295	U32	ro	No	ALL	No																																																																																																																																															
bit	31-28	27-24	23-20	19-16	15-12	11-8	7-4	3-0																																																																																																																																																																										
value (hex)	0	0	0	1	0	0	2	3																																																																																																																																																																										
Application	Major revision				Minor revision																																																																																																																																																																													
04h	Serial number Displays a product serial number. Example) In case of the 13040001 <table border="1" style="margin-left: 20px;"> <thead> <tr> <th>bit</th> <th>31-28</th> <th>27-24</th> <th>23-20</th> <th>19-16</th> <th>15-12</th> <th>11-8</th> <th>7-4</th> <th>3-0</th> </tr> </thead> <tbody> <tr> <td>value (hex)</td> <td>1</td> <td>3</td> <td>0</td> <td>4</td> <td>0</td> <td>0</td> <td>0</td> <td>1</td> </tr> </tbody> </table>	bit	31-28	27-24	23-20	19-16	15-12	11-8	7-4	3-0	value (hex)	1	3	0	4	0	0	0	1	-	0 - 4294967295	U32	ro	No	ALL	No																																																																																																																																																								
bit	31-28	27-24	23-20	19-16	15-12	11-8	7-4	3-0																																																																																																																																																																										
value (hex)	1	3	0	4	0	0	0	1																																																																																																																																																																										
3744h	00h	Software version Displays software version1 and software version2. Example) In case of the Software version1: 1.23 and Software version2: 4.56 <table border="1" style="margin-left: 20px;"> <thead> <tr> <th>bit</th> <th>31-28</th> <th>27-24</th> <th>23-20</th> <th>19-16</th> <th>15-12</th> <th>11-8</th> <th>7-4</th> <th>3-0</th> </tr> </thead> <tbody> <tr> <td>value (hex)</td> <td>0</td> <td>1</td> <td>2</td> <td>3</td> <td>0</td> <td>4</td> <td>5</td> <td>6</td> </tr> <tr> <td>Application</td> <td>(reserved)</td> <td colspan="4">Software version 1 (major) (minor)</td> <td>(reserved)</td> <td colspan="3">Software version 2 (major) (minor)</td> </tr> </tbody> </table>	bit	31-28	27-24	23-20	19-16	15-12	11-8	7-4	3-0	value (hex)	0	1	2	3	0	4	5	6	Application	(reserved)	Software version 1 (major) (minor)				(reserved)	Software version 2 (major) (minor)			-	-2147483648 – 2147483647	I32	ro	No	ALL	Yes																																																																																																																																													
bit	31-28	27-24	23-20	19-16	15-12	11-8	7-4	3-0																																																																																																																																																																										
value (hex)	0	1	2	3	0	4	5	6																																																																																																																																																																										
Application	(reserved)	Software version 1 (major) (minor)				(reserved)	Software version 2 (major) (minor)																																																																																																																																																																											

5-3 Sync Manager Communication Type (1C00h)

Sets the object in 1C00h so as to allocate each Sync Manager to an operation mode.
This value of object is fixed this servo amplifier.

Index	Sub-Index	Name / Description	Units	Range	Data Type	Access	PDO	Op-mode	EEPROM
1C00h		Sync manager communication type Sets the operation mode of each Sync Manager.	-	-	-	-	-	-	-
	00h	Number of used sync manager channels Represents the number of sub-indexes for this object. The value is fixed at 4.	-	0 - 255	U8	ro	No	ALL	No
	01h	Communication type sync manager 0 Sets the application of Sync Manager 0. 0: Not used 1: Reception through Mailbox (master to slave), 3: RxPDO (master to slave) 2: Sending through Mailbox (slave to master), 4: TxPDO (slave to master) Sync Manager 0 is used for receiving data through Mailbox, so the value is fixed at 1.	-	0 - 4	U8	ro	No	ALL	No
	02h	Communication type sync manager 1 Sets the application of Sync Manager 1. 0: Not used 1: Reception through Mailbox (master to slave), 3: RxPDO (master to slave) 2: Sending through Mailbox (slave to master), 4: TxPDO (slave to master) Sync Manager 1 is used for sending data through Mailbox, so the value is fixed at 2.	-	0 - 4	U8	ro	No	ALL	No
	03h	Communication type sync manager 2 Sets the application of Sync Manager 2. 0: Not used 1: Reception through Mailbox (master to slave), 3: RxPDO (master to slave) 2: Sending through Mailbox (slave to master), 4: TxPDO (slave to master) Sync Manager 2 is used for process data output (RxPDO), so the value is fixed at 3.	-	0 - 4	U8	ro	No	ALL	No
	04h	Communication type sync manager 3 Sets the application of Sync Manager 3. 0: Not used 1: Reception through Mailbox (master to slave), 3: RxPDO (master to slave) 2: Sending through Mailbox (slave to master), 4: TxPDO (slave to master) Sync Manager 3 is used for process data input (TxPDO), so the value is fixed at 4.	-	0 - 4	U8	ro	No	ALL	No

5-4 PDO (Process Data Object) Mapping

For the outline of the PDO mapping, also refer to Section 3-7-1 and Section 3-7-2.

5-4-1 PDO Assign Object (1C12h to 1C13h)

Sets the object in 1C12h and 1C13h so as to allocate a PDO mapping table to a Sync Manager.

Index	Sub-Index	Name / Description	Units	Range	Data Type	Access	PDO	Op-mode	EEPROM
1C12h	-	Sync manager channel 2 Sets the PDO mapping object entry for Sync Manager 2. Sync Manager 2 is used as the process data output (RxPDO). It is possible to change this object value only when the ESM state is PreOP. Note: If the sub-index 00h is not cleared to 0 once, 01h - 04h cannot be changed.	-	-	-	-	-	-	-
	00h	Number of assigned PDOs Represents the number of assign object for this object.	-	0 - 4	U8	rw	No	ALL	Yes
	01h	PDO mapping object index of assigned RxPDO 1 Designate the PDO mapping object to be used.	-	1600h - 1603h	U16	rw	No	ALL	Yes
	02h	PDO mapping object index of assigned RxPDO 2 Designate the PDO mapping object to be used.	-	1600h - 1603h	U16	rw	No	ALL	Yes
	03h	PDO mapping object index of assigned RxPDO 3 Designate the PDO mapping object to be used.	-	1600h - 1603h	U16	rw	No	ALL	Yes
	04h	PDO mapping object index of assigned RxPDO 4 Designate the PDO mapping object to be used.	-	1600h - 1603h	U16	rw	No	ALL	Yes
1C13h	-	Sync manager channel 3 Sets the PDO mapping object entry for Sync Manager 3. Sync Manager 3 is used as the process data input (TxPDO). It is possible to change this object value only when the ESM state is PreOP. Note: If the sub-index 00h is not cleared to 0 once, 01h - 04h cannot be changed.	-	-	-	-	-	-	-
	00h	Number of assigned PDOs Represents the number of assign object for this object.	-	0 - 4	U8	rw	No	ALL	Yes
	01h	PDO mapping object index of assigned TxPDO 1 Designate the PDO mapping object to be used.	-	1A00h - 1A03h	U16	rw	No	ALL	Yes
	02h	PDO mapping object index of assigned TxPDO 2 Designate the PDO mapping object to be used.	-	1A00h - 1A03h	U16	rw	No	ALL	Yes
	03h	PDO mapping object index of assigned TxPDO 3 Designate the PDO mapping object to be used.	-	1A00h - 1A03h	U16	rw	No	ALL	Yes
	04h	PDO mapping object index of assigned TxPDO 4 Designate the PDO mapping object to be used.	-	1A00h - 1A03h	U16	rw	No	ALL	Yes

NOTE) It is possible to change subindex 01h-04h of 1C12h,1C13h value only when the ESM state is PreOP and subindex00h=0. Abort Code(06010003h) is returned in any other state.
After changing the settings, the PDO assign object is reflected when the sub-index 00h is set to number of subindexes to be used and the ESM state transitions to SafeOP.

5-4-2 PDO Mapping Object (1600h to 1603h, 1A00h to 1A03h)

As the PDO mapping table, the object from 1600h to 1603h can be used for RxPDO and the object from 1A00h to 1A03h for TxPDO.

The subindex 01h or later indicate the information of the application object to be mapped.

Index	Sub-Index	Name / Description	Units	Range	Data Type	Access	PDO	Op-mode	EEPROM
1600h	-	Receive PDO mapping 1 Indicates an RxPDO object. It is possible to change this object value only when the ESM state is PreOP. Note: If the sub-index 00h is not cleared to 0 once, 01h - 20h cannot be changed.	-	-	-	-	-	-	-
	00h	Number of entries Set the number of RxPDO objects mapped to this object.	-	0 - 32	U8	rw	No	ALL	Yes
	01h	1st Receive PDO mapped Set an object to be mapped 1st.	-	0 - 4294967295	U32	rw	No	ALL	Yes
			bit	31 ... 16	15 ... 08	07 ... 01	Index number Subindex number Bit length		
	02h	2nd Receive PDO mapped Set an object to be mapped 2nd. The same setting method as the sub-index 01h.	-	0 - 4294967295	U32	rw	No	ALL	Yes
	03h	3rd Receive PDO mapped Set an object to be mapped 3rd. The same setting method as the sub-index 01h.	-	0 - 4294967295	U32	rw	No	ALL	Yes
	04h	4th Receive PDO mapped Set an object to be mapped 4th. The same setting method as the sub-index 01h.	-	0 - 4294967295	U32	rw	No	ALL	Yes
	05h	5th Receive PDO mapped Set an object to be mapped 5th. The same setting method as the sub-index 01h.	-	0 - 4294967295	U32	rw	No	ALL	Yes
	06h	6th Receive PDO mapped Set an object to be mapped 6th. The same setting method as the sub-index 01h.	-	0 - 4294967295	U32	rw	No	ALL	Yes
	07h	7th Receive PDO mapped Set an object to be mapped 7th. The same setting method as the sub-index 01h.	-	0 - 4294967295	U32	rw	No	ALL	Yes
	08h	8th Receive PDO mapped Set an object to be mapped 8th. The same setting method as the sub-index 01h.	-	0 - 4294967295	U32	rw	No	ALL	Yes
	⋮								
	20h	32nd Receive PDO mapped Set an object to be mapped 32nd. The same setting method as the sub-index 01h.	-	0 - 4294967295	U32	rw	No	ALL	Yes
1601h	-	Receive PDO mapping 2 The specification of the subindex, etc. is the same as 1600h.	-	-	-	-	-	-	-
1602h	-	Receive PDO mapping 3 The specification of the subindex, etc. is the same as 1600h.	-	-	-	-	-	-	-
1603h	-	Receive PDO mapping 4 The specification of the subindex, etc. is the same as 1600h.	-	-	-	-	-	-	-

NOTE)

- Please do not overlap the same object mapping.

The action at the time of carrying out a duplication setup is not guaranteed.

- It is possible to change subindex 01h-20h of 1600h-1603h value only when the ESM state is PreOP and subindex00h=0. Abort Code(06010003h) is returned in any other state.

After changing the settings, the PDO mapping object is reflected when the sub-index 00h is set to number of subindexes to be used and the ESM state transitions to SafeOP.

Index	Sub-Index	Name / Description	Units	Range	Data Type	Access	PDO	Op-mode	EEPROM												
1A00h	-	Transmit PDO mapping 1 Indicates the TxPDO object. It is possible to change this object value only when the ESM state is PreOP. Note: If the sub-index 00h is not cleared to 0 once, 01h - 20h cannot be changed.	-	-	-	-	-	-	-												
	00h	Number of entries Set the number of TxPDO objects mapped to this object.	-	0 - 32	U8	rw	No	ALL	Yes												
	01h	1st Transmit PDO mapped Set an object to be mapped 1st.	0 - 4294967295	U32	rw	No	ALL	Yes													
			<table border="1"> <thead> <tr> <th>bit</th> <th>31</th> <th>...</th> <th>16</th> <th>15</th> <th>...</th> <th>08</th> <th>07</th> <th>...</th> <th>01</th> </tr> </thead> <tbody> <tr> <td colspan="5">Index number</td> <td colspan="3">Subindex number</td> <td colspan="2">Bit length</td> </tr> </tbody> </table>	bit	31	...	16	15	...	08	07	...	01	Index number					Subindex number		
	bit	31	...	16	15	...	08	07	...	01											
	Index number					Subindex number			Bit length												
	02h	2nd Transmit PDO mapped Set an object to be mapped 2nd. The same setting method as the sub-index 01h.	-	0 - 4294967295	U32	rw	No	ALL	Yes												
	03h	3rd Transmit PDO mapped Set an object to be mapped 3rd. The same setting method as the sub-index 01h.	-	0 - 4294967295	U32	rw	No	ALL	Yes												
	04h	4th Transmit PDO mapped Set an object to be mapped 4th. The same setting method as the sub-index 01h.	-	0 - 4294967295	U32	rw	No	ALL	Yes												
	05h	5th Transmit PDO mapped Set an object to be mapped 5th. The same setting method as the sub-index 01h.	-	0 - 4294967295	U32	rw	No	ALL	Yes												
	06h	6th Transmit PDO mapped Set an object to be mapped 6th. The same setting method as the sub-index 01h.	-	0 - 4294967295	U32	rw	No	ALL	Yes												
	07h	7th Transmit PDO mapped Set an object to be mapped 7th. The same setting method as the sub-index 01h.	-	0 - 4294967295	U32	rw	No	ALL	Yes												
	08h	8th Transmit PDO mapped Set an object to be mapped 8th. The same setting method as the sub-index 01h.	-	0 - 4294967295	U32	rw	No	ALL	Yes												
	⋮	⋮																			
20h	32nd Transmit PDO mapped Set an object to be mapped 32nd. The same setting method as the sub-index 01h.	-	0 - 4294967295	U32	rw	No	ALL	Yes													
1A01h	-	Transmit PDO mapping 2 The specification of the subindex, etc. is the same as 1A00h.	-	-	-	-	-	-	-												
1A02h	-	Transmit PDO mapping 3 The specification of the subindex, etc. is the same as 1A00h.	-	-	-	-	-	-	-												
1A03h	-	Transmit PDO mapping 4 The specification of the subindex, etc. is the same as 1A00h.	-	-	-	-	-	-	-												

NOTE)

- Please do not overlap the same object mapping.

The action at the time of carrying out a duplication setup is not guaranteed.

- It is possible to change subindex 01h-20h of 1A00h-1A03h value only when the ESM state is PreOP and subindex00h=0. Abort Code(06010003h) is returned in any other state.

After changing the settings, the PDO mapping object is reflected when the sub-index 00h is set to number of subindexes to be used and the ESM state transitions to SafeOP.

5-4-3 Default PDO Mapping

This section describes the default PDO mapping definition in MINAS-A5B.

This default PDO mapping provides the values of the PDO mapping objects at the time of shipment.

This mapping is defined in ESI File (.xml format).

Moreover, a shipment value is determined in the following formats.

bit	31	...	16	15	...	08	07	...	01
	Index No.			Sub-Index No.			bit size		

- PDO mapping 1

For position control (Touch probe available)

	Index	Sub-Index	Size (bit)	Name	Shipment value
RxPDO (1600h)	6040h	00h	16	Controlword	60400010h
	6060h	00h	8	Modes of operation	60600008h
	607Ah	00h	32	Target Position	607A0020h
	60B8h	00h	16	Touch probe function	60B80010h
TxPDO (1A00h)	603Fh	00h	16	Error code	603F0010h
	6041h	00h	16	Statusword	60410010h
	6061h	00h	8	Modes of operation display	60610008h
	6064h	00h	32	Position actual value	60640020h
	60B9h	00h	16	Touch probe status	60B90010h
	60BAh	00h	32	Touch probe pos1 pos value	60BA0020h
	60F4h	00h	32	Following error actual value	60F40020h
60FDh	00h	32	Digital inputs	60FD0020h	

- PDO mapping 2

For position, velocity, and torque control (Touch probe available)

	Index	Sub-Index	Size (bit)	Name	Shipment value
RxPDO (1601h)	6040h	00h	16	Controlword	60400010h
	6060h	00h	8	Modes of operation	60600008h
	6071h	00h	16	Target Torque	60710010h
	607Ah	00h	32	Target Position	607A0020h
	6080h	00h	32	Max motor speed	60800020h
	60B8h	00h	16	Touch probe function	60B80010h
	60FFh	00h	32	Target Velocity	60FF0020h
TxPDO (1A01h)	603Fh	00h	16	Error code	603F0010h
	6041h	00h	16	Statusword	60410010h
	6061h	00h	8	Modes of operation display	60610008h
	6064h	00h	32	Position actual value	60640020h
	606Ch	00h	32	Velocity actual value	606C0020h
	6077h	00h	16	Torque actual value	60770010h
	60B9h	00h	16	Touch probe status	60B90010h
	60BAh	00h	32	Touch probe pos1 pos value	60BA0020h
	60FDh	00h	32	Digital inputs	60FD0020h

- PDO mapping 3

For position and velocity control (Touch probe and torque limit available)

	Index	Sub-Index	Size (bit)	Name	Shipment value
RxPDO (1602h)	6040h	00h	16	Controlword	60400010h
	6060h	00h	8	Modes of operation	60600008h
	6072h	00h	16	Max torque	60720010h
	607Ah	00h	32	Target Position	607A0020h
	60B8h	00h	16	Touch probe function	60B80010h
	60FFh	00h	32	Target Velocity	60FF0020h
TxPDO (1A02h)	603Fh	00h	16	Error code	603F0010h
	6041h	00h	16	Statusword	60410010h
	6061h	00h	8	Modes of operation display	60610008h
	6064h	00h	32	Position actual value	60640020h
	606Ch	00h	32	Velocity actual value	606C0020h
	6077h	00h	16	Torque actual value	60770010h
	60B9h	00h	16	Touch probe status	60B90010h
	60BAh	00h	32	Touch probe pos1 pos value	60BA0020h
60FDh	00h	32	Digital inputs	60FD0020h	

- PDO mapping 4

For position, velocity, and torque control (Touch probe and torque limit available)

	Index	Sub-Index	Size (bit)	Name	Shipment value
RxPDO (1603h)	6040h	00h	16	Controlword	60400010h
	6060h	00h	8	Modes of operation	60600008h
	6071h	00h	16	Target Torque	60710010h
	6072h	00h	16	Max torque	60720010h
	607Ah	00h	32	Target Position	607A0020h
	6080h	00h	32	Max motor speed	60800020h
	60B8h	00h	16	Touch probe function	60B80010h
	60FFh	00h	32	Target Velocity	60FF0020h
TxPDO (1A03h)	603Fh	00h	16	Error code	603F0010h
	6041h	00h	16	Statusword	60410010h
	6061h	00h	8	Modes of operation display	60610008h
	6064h	00h	32	Position actual value	60640020h
	606Ch	00h	32	Velocity actual value	606C0020h
	6077h	00h	16	Torque actual value	60770010h
	60B9h	00h	16	Touch probe status	60B90010h
	60BAh	00h	32	Touch probe pos1 pos value	60BA0020h
60FDh	00h	32	Digital inputs	60FD0020h	

5-4-4 PDO Mapping Setting Procedure

The procedure for setting the PDO mapping is explained using the case where 6081h-00h (Profile velocity) is added to 1600h (Receive PDO mapping 1) as an example.

Before change

Index	Set value	Object description	
1600h-01h	60400010h	6040h-00h	Controlword
1600h-02h	60600008h	6060h-00h	Modes of operation
1600h-03h	607A0020h	607Ah-00h	Target Position
1600h-04h	60B80010h	60B8h-00h	Touch probe function

After change

Index	Set value	Object description	
1600h-01h	60400010h	6040h-00h	Controlword
1600h-02h	60600008h	6060h-00h	Modes of operation
1600h-03h	607A0020h	607Ah-00h	Target Position
1600h-04h	60B80010h	60B8h-00h	Touch probe function
1600h-05h	60810020h	6081h-00h	Profile velocity

← Addition

<Setting method 1> In case of setting using SDO message

- 1) Transition the ESM status from Init to PreOP.
It will be possible to transmit the SDO message using the Mailbox protocol.
- 2) Set the value of 1600h-00h to 0 with the SDO message.
To change SubIndex = 01h or later, it is necessary to set it to 0 temporarily.
- 3) Set the value of 1600h-05h to 60810020h with the SDO message.
The meaning of 60810020h of the set value is the following.

6	0	8	1	0	0	2	0	h
Index number				SubIndex number		Bit length		

- 4) Set the value of 1600h-00h to 5 with the SDO message.
It means that the setting of 1600h is used until SubIndex = 05h.
- 5) Transition the ESM status from PreOP to SafeOP.
TxPDO will be effective.
- 6) Transition the ESM status from SafeOP to OP.
RxPDO will be effective.

* If the change description is written into EEPROM by setting the value of 1010-01h to 65766173h with the SDO message after the setting of 4), the setting of 2) to 4) will be unnecessary from the next activation.
For the writing method of EEPROM, refer to Section 5-6.

<Setting method 2> In case of setting using object editor function of PANATERM

- 1) Transition the ESM status to Init to activate the object editor.
If setting an object from the object editor, it is necessary to set the ESM status to Init.

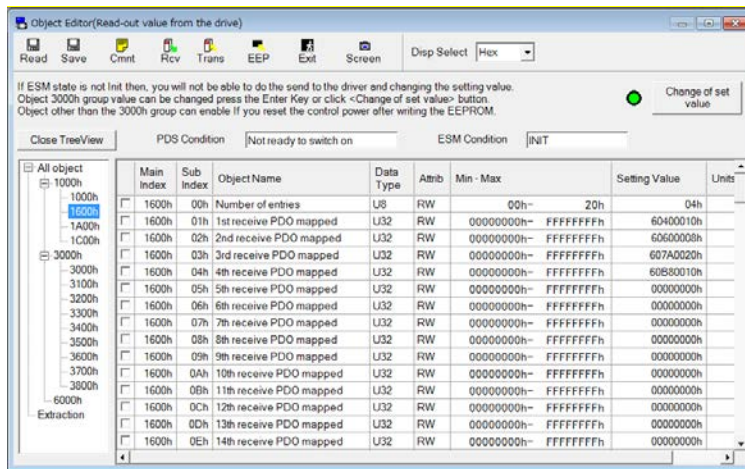

- 2) Set the value of 1600h-00h to 5 and click the “Change of set value” or press the Enter key.
- 3) Set the value of 1600h-05h to 60810020h and click the “Change of set value” or press the Enter key.
If setting it from the object editor, it is not necessary to set the value of 1600h-00h to 0 temporarily.
Also, even if the order of 2) and 3) is changed, there is no problem.

Main Index	Sub Index	Object Name	Data Type	Attrib	Min - Max	Setting Value	Units
1600h	00h	Number of entries	U8	RW	00h- 20h	05h	
1600h	01h	1st receive PDO mapped	U32	RW	00000000h- FFFFFFFFh	60400010h	
1600h	02h	2nd receive PDO mapped	U32	RW	00000000h- FFFFFFFFh	60600008h	
1600h	03h	3rd receive PDO mapped	U32	RW	00000000h- FFFFFFFFh	607A0020h	
1600h	04h	4th receive PDO mapped	U32	RW	00000000h- FFFFFFFFh	60B80010h	
1600h	05h	5th receive PDO mapped	U32	RW	00000000h- FFFFFFFFh	60810020h	
1600h	06h	6th receive PDO mapped	U32	RW	00000000h- FFFFFFFFh	00000000h	
1600h	07h	7th receive PDO mapped	U32	RW	00000000h- FFFFFFFFh	00000000h	

- 4) Click the “EEP” icon to write it into EEPROM.

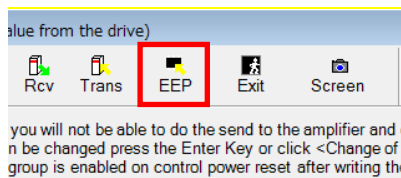

- 5) Turn on the control power again.
- 6) Transition the ESM status from init to PreOP.
- 7) Transition the ESM status from PreOP to SafeOP.
TxPDO will be effective.
- 8) Transition the ESM status from SafeOP to OP.
RxPDO will be effective.

Index	Sub-Index	Name / Description	Units	Range	Data Type	Access	PDO	Op-mode	EEPRO M
1C32h	05h	Minimum cycle time Minimum value from the SM2 or Sync0 event until the completion to write or to read out to the ESC. It is 17000 for this servo amplifier. *1) Set 250000 (250 μs), 500000 (500 μs), 1000000 (1 ms), 2000000 (2 ms), or 4000000 (4 ms) to 1C32h-02h. Setting other values causes Err81.0 (Synchronization cycle error protection).	ns	0 - 4294967295	U32	ro	No	ALL	No
	06h	Calc and copy time Time from the SM2 or Sync0 event to the generation of the PWM signal. It is 500000 for this servo amplifier. *1)	ns	0 - 4294967295	U32	ro	No	ALL	No
	08h	Command Not supported	-	0 - 65535	U16	ro	No	ALL	No
	09h	Delay Time Time from the PWM command output to the turning ON/OFF of power transistor output. It is 0 for this servo amplifier. *1)	ns	0 - 4294967295	U32	ro	No	ALL	No
	0Ah	Sync0 cycle time In the case of DC SYNC0 (1C32h-01h=02h), the value 09A0h is set to the ESC register. In other cases, 0 is set.	ns	0 - 4294967295	U32	ro	No	ALL	No
	0Bh	Cycle time too small Not supported	-	0 - 65535	U16	ro	No	ALL	No
	0Ch	SM-event missed Not supported	-	0 - 65535	U16	ro	No	ALL	No
	0Dh	Shift time too short Not supported	-	0 - 65535	U16	ro	No	ALL	No
	0Eh	RxPDO toggle failed Not supported	-	0 - 65535	U16	ro	No	ALL	No
	20h	Sync error Not supported	-	0 - 1	BOOL	ro	No	ALL	No

*1) These setting values are only for reference and do not guarantee their descriptions.

◆ Sync manager 3 synchronization

Index	Sub-Index	Name / Description	Units	Range	Data Type	Access	PDO	Op-mode	EEPROM																				
1C33h	-	Sync manager3 synchronization Sync manager3 is set up.	-	-	-	-	-	-	-																				
	00h	Number of sub-objects Represents the number of sub-indexes for this object. The value is fixed at 20h.	-	0 - 255	U8	ro	No	ALL	No																				
	01h	Sync mode Set the synchronous mode of Sync Manager 3. 00h: Free Run (not synchronized) 01h: Not supported (Can not be set) 02h: DC SYNC0 (synchronized with Sync0 Event) 03h: Not supported (Can not be set) 22h: SM2 (Synchronous with SM2 Event) - In accordance with the combination with the setting of ESC register 0981h (DC-Activation) (following table), set the set value of this object to the transition time from PreOP to SafeOP automatically.	-	0 - 65535	U16	rw	No	ALL	Yes																				
			<table border="1"> <thead> <tr> <th>ESC register 0981h set status</th> <th>1C33h-02h set value</th> <th></th> <th>Value of 1C33h-02h changed at time of transition from PreOP to SafeOP</th> </tr> </thead> <tbody> <tr> <td rowspan="3">DC enable ON</td> <td>00h : FreeRun</td> <td rowspan="6">⇒</td> <td>02h : DC SYNC0</td> </tr> <tr> <td>22h : SM2</td> <td>02h : DC SYNC0</td> </tr> <tr> <td>02h : DC SYNC0</td> <td>02h : DC SYNC0</td> </tr> <tr> <td rowspan="3">DC enable OFF</td> <td>00h : FreeRun</td> <td>00h : FreeRun</td> </tr> <tr> <td>22h : SM2</td> <td>22h : SM2</td> </tr> <tr> <td>02h : DC SYNC0</td> <td>00h : FreeRun</td> </tr> </tbody> </table>	ESC register 0981h set status	1C33h-02h set value		Value of 1C33h-02h changed at time of transition from PreOP to SafeOP	DC enable ON	00h : FreeRun	⇒	02h : DC SYNC0	22h : SM2	02h : DC SYNC0	02h : DC SYNC0	02h : DC SYNC0	DC enable OFF	00h : FreeRun	00h : FreeRun	22h : SM2	22h : SM2	02h : DC SYNC0	00h : FreeRun							
	ESC register 0981h set status	1C33h-02h set value		Value of 1C33h-02h changed at time of transition from PreOP to SafeOP																									
	DC enable ON	00h : FreeRun	⇒	02h : DC SYNC0																									
		22h : SM2		02h : DC SYNC0																									
		02h : DC SYNC0		02h : DC SYNC0																									
	DC enable OFF	00h : FreeRun		00h : FreeRun																									
		22h : SM2		22h : SM2																									
02h : DC SYNC0		00h : FreeRun																											
02h	Cycle time Sets the cycle of Sync Manager. The same value is set as 1C32h:02h.	ns	0 - 4294967295	U32	ro	No	ALL	No																					
03h	Shift time Set the time from the Sync0 and SM2 events until slave CPU write value of the RxPDO to ESC. Set the value in steps of 250000 and value under the Cycle time. Normally, set 0.	ns	0 - 4294967295	U32	rw	No	ALL	No																					
04h	Sync modes supported Sets the synchronous type to be supported. bit 0: Free Run mode support 0: Not supported, 1: Free run mode support This servo amplifier will be set to 1 bit 1: SM synchronous mode support 0: Not supported, 1: SM2 event synchronous support This servo amplifier will be set to 1 bit 4-2: DC synchronous type support 000b: Not supported 001b: DC Sync0 event support This servo amplifier will be set to 001b bit 6-5: Input shift support 00b: Not supported 01b: Shift support for a local timer This servo amplifier will be set to 01b bit 7-15: Reserved	-	0 - 65535	U16	ro	No	ALL	No																					

Index	Sub-Index	Name / Description	Units	Range	Data Type	Access	PDO	Op-mode	EEPROM
1C33h	05h	Minimum cycle time Minimum value from the SM2 or Sync0 event until the completion to write or to read out to the ESC. The same value as 1C32h:05h.	ns	0 - 4294967295	U32	ro	No	ALL	No
	06h	Calc and copy time Time from the data latching in the encoder to the writing of communication data in the ESC register. It is 400000 for this servo amplifier. *1)	ns	0 - 4294967295	U32	ro	No	ALL	No
	08h	Command Not supported	-	0 - 65535	U16	ro	No	ALL	No
	09h	Delay time Time from the PWM command output to the turning ON/OFF of power transistor output. The same value as 1C32h:09h.	ns	0 - 4294967295	U32	ro	No	ALL	No
	0Ah	Sync0 cycle time The same value as 1C32h-0Ah.	ns	0 - 4294967295	U32	ro	No	ALL	No
	0Bh	Cycle time too small Not supported	-	0 - 65535	U16	ro	No	ALL	No
	0Ch	SM-event missed Not supported	-	0 - 65535	U16	ro	No	ALL	No
	0Dh	Shift time too short Not supported	-	0 - 65535	U16	ro	No	ALL	No
	0Eh	RxPDO toggle failed Not supported	-	0 - 65535	U16	ro	No	ALL	No
	20h	Sync error Not supported	-	0 - 1	BOOL	ro	No	ALL	No

*1) These setting values are only for reference and do not guarantee their descriptions.

5-5-1 DC (synchronous with SYNC0 event)

This section describes the DC synchronous mode specification for this amplifier.

Synchronization method	Characteristic
Synchronize the time information of other slaves based on the time of the first shaft.	<ul style="list-style-type: none"> •High accuracy •Correction process is required on the master side.

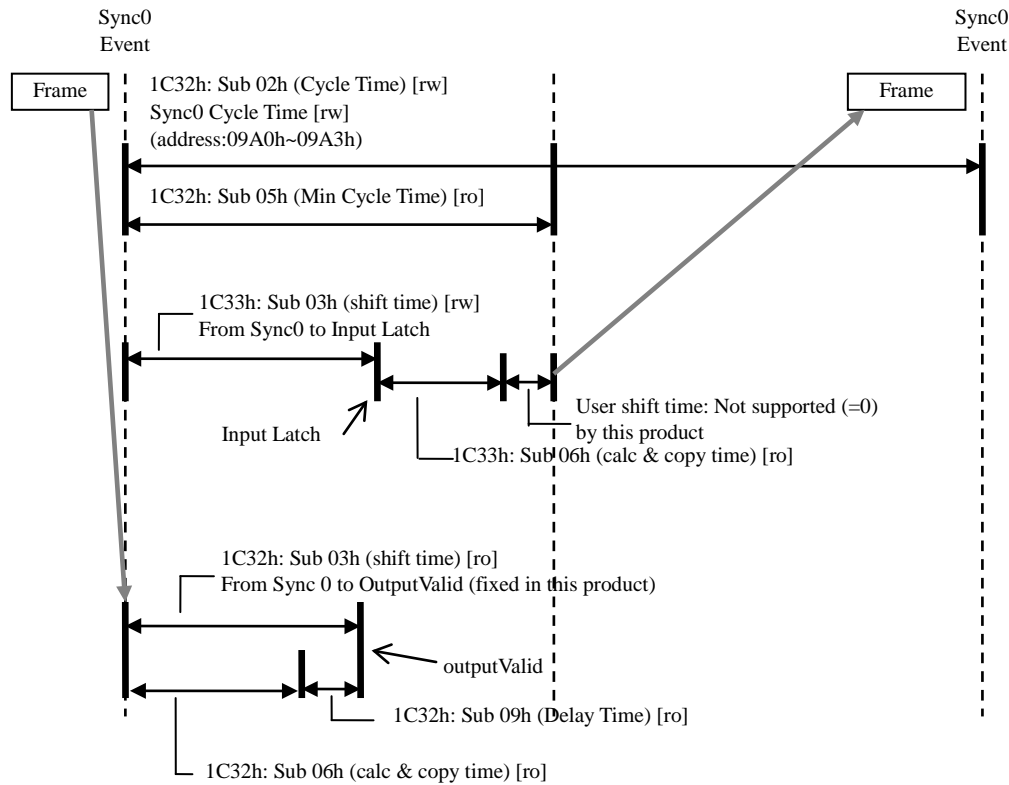

Synchronization setting for Sync manager 2/3 during the DC synchronous mode

Index	Sub-Index	Access	Name	Value
1C32h	00h	ro	Number of sub-objects	20h
	01h	rw	Sync mode	02h:DC SYNC0 (synchronized with Sync0 Event)
	02h	rw	Cycle Time	250 μs: 250000, 500 μs: 500000, 1 ms: 1000000 2ms:2000000 4ms:4000000
	03h	ro	Shift Time	Not supported
	04h	ro	Sync modes supported	Bits 4-2: DC synchronous type support 001b: DC Sync 0 event support
	05h	ro	Minimum Cycle Time	17000 *1)
	06h	ro	Calc And Copy Time	500000 *1)
	09h	ro	Delay Time	0 *1)
	0Ah	ro	Sync0 Cycle Time	Value of ESC register 0x09A0
	0Bh	ro	Cycle time too small	Not supported
	0Ch	ro	SM-event missed	Not supported
	0Dh	ro	Shift time too short	Not supported
	20h	ro	Sync Error	Not supported

*1) These setting values are only for reference and do not guarantee their descriptions.

Index	Sub-Index	Access	Name	Value
1C33h	00h	ro	Number of sub-objects	Same setting as 1C32h:00h.
	01h	rw	Sync mode	02h:DC SYNC0 (synchronized with Sync0 Event)
	02h	ro	Cycle Time	Same setting as 1C32h:02h.
	03h	rw	Shift Time	0 or 250000 ns to 3750000 ns (Set the writing timing of the RxPDO value from slave CPU to ESC in steps of 250000.)
	04h	ro	Sync modes supported	Bits 4-2: DC synchronous type support 001b: DC Sync 0 event support Bits 6-5: Input shift support 00b: Not supported 01b: Shift support for a local timer
	05h	ro	Minimum Cycle Time	Same setting as 1C32h:05h.
	06h	ro	Calc And Copy Time	400000 *1)
	09h	ro	Delay Time	Same setting as 1C32h:09h.
	0Ah	ro	Sync0 Cycle Time	Same setting as 1C32h:0Ah
	0Bh	ro	Cycle time too small	Not supported
	0Ch	ro	SM-event missed	Not supported
	0Dh	ro	Shift time too short	Not supported
	20h	ro	Sync Error	Not supported

*1) These setting values are only for reference and do not guarantee their descriptions.

5-5-2 SM2 (synchronous with SM2 event)

Synchronization method	Characteristic
Synchronize it to the reception timing of RxPDO.	<ul style="list-style-type: none"> •There is no transmission delay correction and accuracy is low. •It is necessary to keep the transmission timing constant on the controller side. (dedicated hardware etc.)

This section describes the SM2 mode specification for this amplifier.

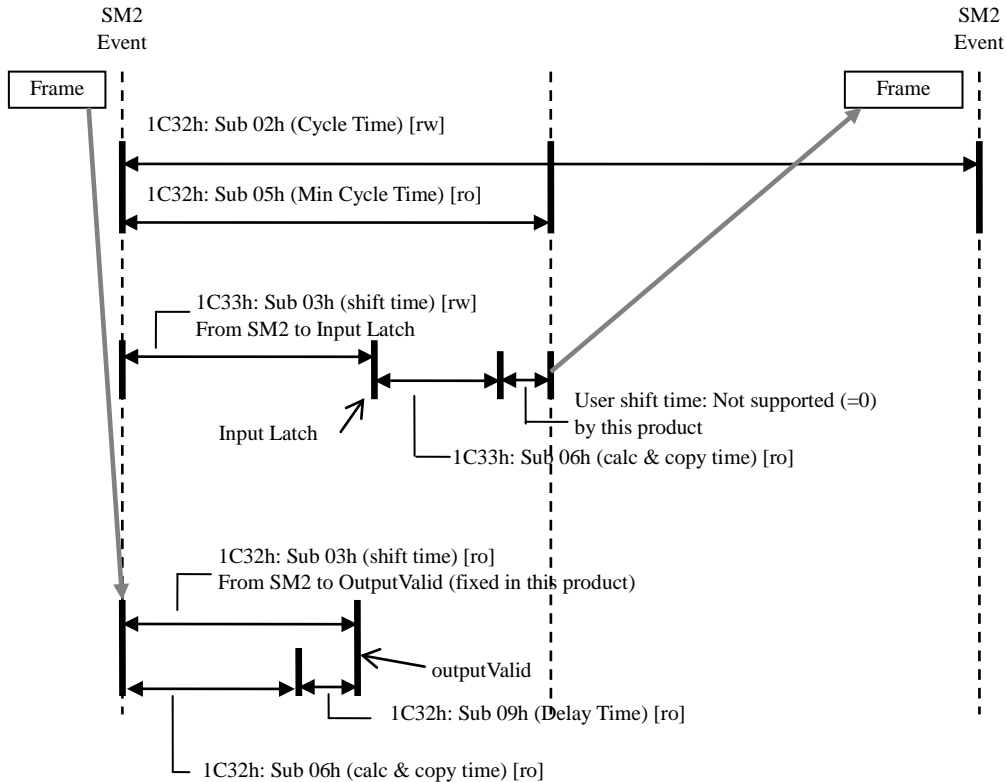

Synchronization setting for Sync manager 2/3 during the SM2 event synchronous mode

Index	Sub-Index	Access	Name / Description	Value
1C32h	00h	ro	Number of sub-objects	20h (fixed)
	01h	rw	Sync mode	01h:Synchronous (synchronized with SM Event)
	02h	rw	Cycle Time	250 μs: 250000, 500 μs: 500000, 1 ms: 1000000 2ms:2000000 4ms:4000000
	03h	ro	Shift Time	Not supported
	04h	ro	Sync modes supported	bit 1: SM synchronous mode support 1: SM2 event synchronization support
	05h	ro	Minimum Cycle Time	17000 *1)
	06h	ro	Calc And Copy Time	500000 *1)
	09h	ro	Delay Time	0 *1)
	0Ah	ro	Sync0 Cycle Time	0
	0Bh	ro	Cycle time too small	Not supported
	0Ch	ro	SM-event missed	Not supported
	0Dh	ro	Shift time too short	Not supported
20h	ro	Sync Error	Not supported	

*1) These setting values are only for reference and do not guarantee their descriptions.

Index	Sub-Index	Access	Name / Description	Value
1C33h	00h	ro	Number of sub-objects	Same setting as 1C32h:00h.
	01h	rw	Sync mode	22h: SM2 (Synchronous with SM2 Event)
	02h	ro	Cycle Time	Same setting as 1C32h:02h.
	03h	rw	Shift Time	0 or 250000 ns to 3750000 ns (in steps of 250000 ns)
	04h	ro	Sync modes supported	Same setting as 1C32h:04h.
	05h	ro	Minimum Cycle Time	Same setting as 1C32h:05h.
	06h	ro	Calc And Copy Time	400000 *1)
	09h	ro	Delay Time	Same setting as 1C32h:09h.
	0Ah	ro	Sync0 Cycle Time	Same setting as 1C32h:0Ah.
	0Bh	ro	Cycle time too small	Not supported
	0Ch	ro	SM-event missed	Not supported
	0Dh	ro	Shift time too short	Not supported
20h	ro	Sync Error	Not supported	

*1) These setting values are only for reference and do not guarantee their descriptions.

5-5-3 Free RUN (asynchronous)

Synchronization method	Characteristic
Asynchronous	<ul style="list-style-type: none"> •Process is simple. •Real-time characteristics are insufficient.

This section describes the Free Run mode specification for this amplifier.

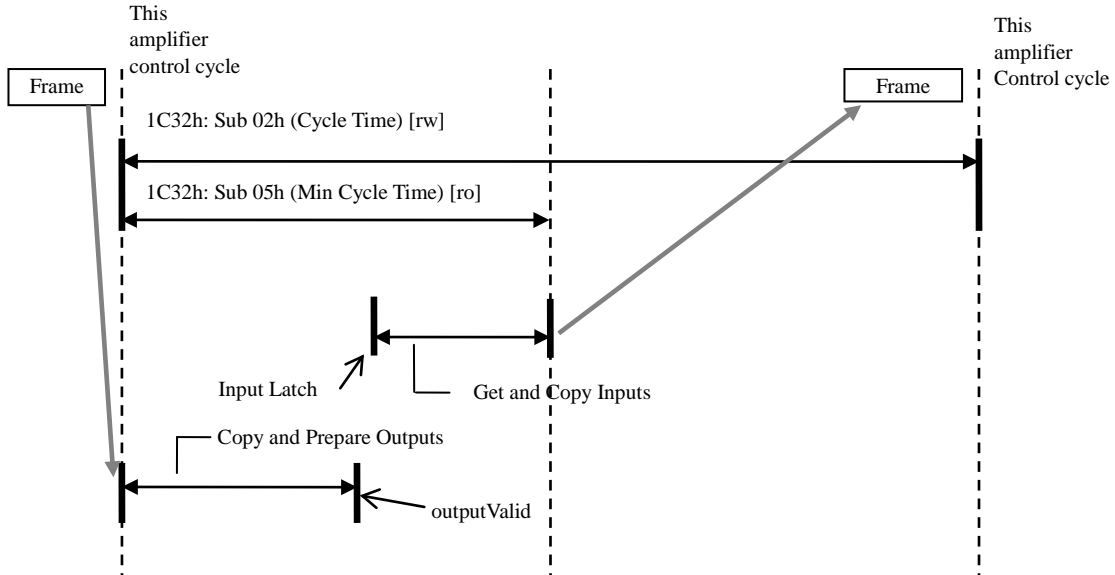

Synchronization setting for Sync manager 2/3 during the Free Run mode

Index	Sub-Index	Access	Name	Value
1C32h	00h	ro	Number of sub-objects	20h (fixed)
	01h	rw	Sync mode	00h:Free Run (not synchronized)
	02h	rw	Cycle Time	250 μs: 250000, 500 μs: 500000, 1 ms: 1000000 2ms:2000000 4ms:4000000
	03h	ro	Shift Time	Not supported
	04h	ro	Sync modes supported	bit 0: Free Run mode support 1: Free Run mode support
	05h	ro	Minimum Cycle Time	17000 *1)
	06h	ro	Calc And Copy Time	Not supported
	09h	ro	Delay Time	Not supported
	0Ah	ro	Sync0 Cycle Time	0
	0Bh	ro	Cycle time too small	Not supported
	0Ch	ro	SM-event missed	Not supported
	0Dh	ro	Shift time too short	Not supported
	20h	ro	Sync Error	Not supported

*1) These setting values are only for reference and do not guarantee their descriptions.

Index	Sub-Index	Access	Name	Value
1C33h	00h	ro	Number of sub-objects	Same setting as 1C32h:00h.
	01h	rw	Sync mode	00h: FreeRun (not synchronized)
	02h	ro	Cycle Time	Same setting as 1C32h:02h.
	03h	rw	Shift Time	Not supported
	04h	ro	Sync modes supported	Same setting as 1C32h:04h.
	05h	ro	Minimum Cycle Time	Same setting as 1C32h:05h.
	06h	ro	Calc And Copy Time	Same setting as 1C32h:06h.
	09h	ro	Delay Time	Same setting as 1C32h:09h.
	0Ah	ro	Sync0 Cycle Time	Same setting as 1C32h:0Ah.
	0Bh	ro	Cycle time too small	Not supported
	0Ch	ro	SM-event missed	Not supported
	0Dh	ro	Shift time too short	Not supported
	20h	ro	Sync Error	Not supported

*1) These setting values are only for reference and do not guarantee their descriptions.

5-5-4 Input shift time

To provide the newest slave information to the master, it is supported for the input shift time. By setting 1C33h-03h (Shift time), it is possible to adjust the timing of Input Latch with accuracy of 250 μ s and set it to a value most immediately before the TxPDO frame transmission. In particular, it is effective for the case where the communication cycle (cycle time) is extended.

<DC Cycle Time = 1ms, Input shift time = 0 μ s>

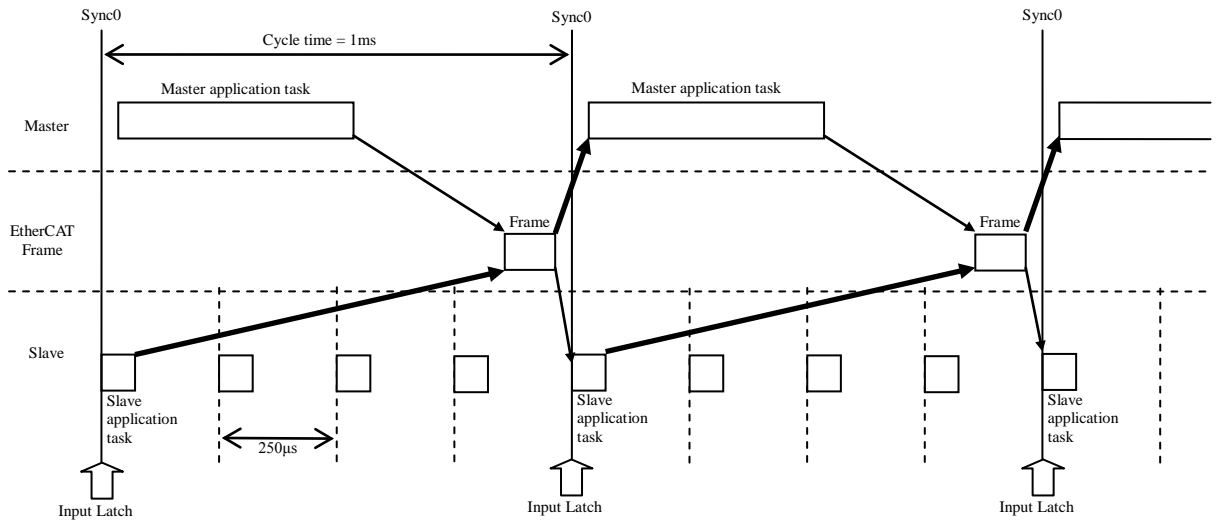

<DC Cycle Time = 1ms, Input shift time = 750 μ s>

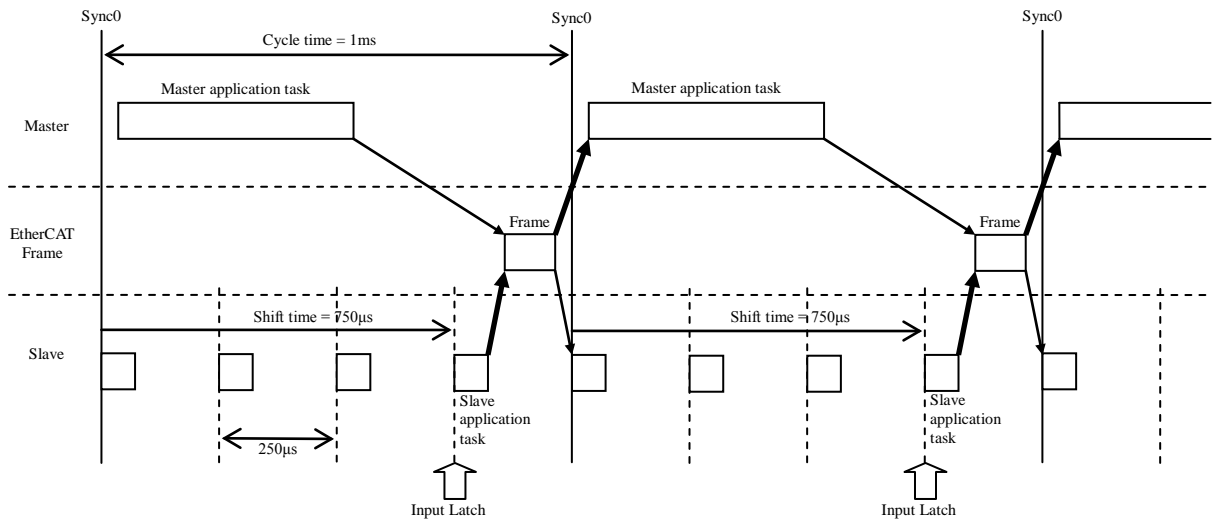

5-6 Store Parameters (write object in EEPROM) (1010h)

Send 65766173h(“save”) to a slave with the EtherCAT communication data by using the object 1010h-01h (Save all parameters) to batch write (back up) different object data in EEPROM and RAM into EEPROM.

Index	Sub-Index	Name / Description	Units	Range	Data Type	Access	PDO	Op-mode	EEPROM
1010h	-	Store parameters Writes (backs up) the object data into EEPROM. Only the objects whose EEPROM field in the object list are "Yes" are backed up.	-	-	-	-	-	-	-
	00h	Number of entries Represents the number of sub-indexes for this object. The value is fixed at 1.	-	0 - 255	U8	ro	No	ALL	No
	01h	Save all parameters Write 65766173h(“save”) into the EtherCAT communication data to batch back up the whole target objects into EEPROM. When the process is completed, it will be 00000001h regardless of pass or fail. Read-out after power-on is 00000001h.	-	0 - 4294967295	U32	rw	No	ALL	No

- Only the objects whose EEPROM field in the object list is "Yes" are backed up.

Index	Sub-Index	Name	Units	Range	Data Type	Access	PDO	Op-mode	EEPROM
607Dh	-	Software position limit	-	-	-	-	-	-	-
	00h	Number of entries	-	2	U8	ro	No	ppip	No
	01h	Min position limit	command	-2147483648 - 2147483647	I32	rw	R&PDO	...	Yes

*This table is a thing for explanation.
Please understand that it differs from an actual object list.

Objects whose value of this field is "Yes" are backed up.

- When “Control power undervoltage protection” (Err.11.0) occurs, EEPROM cannot be accessed and the objects cannot be saved in EEPROM.
- The objects of the attributes C and R in the servo parameter area (object 3000s) will be effective after resetting the control power.
For information to Attributes of servo parameter, refer to Basic function specifications of the Technical document(SX-DSV02472).
- The writing count into EEPROM is limited.
- In writing into EEPROM, about 10 seconds maximum. (when changing all objects)
- During writing into EEPROM, other SDO commands are not received.
- In cases below, an abort message is returned:
Write access to 1010h-00h
The data written to 1010h-01h is other than 65766173h(“save”)
For other abort messages, refer to Section 3-6-1.

5-7 Diagnosis history (Reading Function of Error (alarm) History) (10F3h)

Use the object 10F3h (Diagnosis history) to read up to 14 error (alarm) histories.

The error (alarm) histories are stored up to 14 limit. They are placed from 10F3h-06h (Diagnosis message 1) to 103Fh-13h (Diagnosis message 14) one by one in the order of occurrence.

The subindex number in which the latest error (alarm) history was stored can be checked in 103Fh-02h (Newest Message).

At the time of control power on, the error (alarm) history at 10F3h (Diagnosis history) is set by reading the information backed up at EEPROM of this servo amplifier.

The error(alarm) history displayed by 10F3h (Diagnosis history) serves as only alarm generated with this servo amplifier.

Therefore, warning is not displayed.

There is alarm which is not stored and displayed by 10F3h (Diagnosis history).

Please refer to "7-1. List of protective function" of Functional Specification (SX-DSV02472) for details.

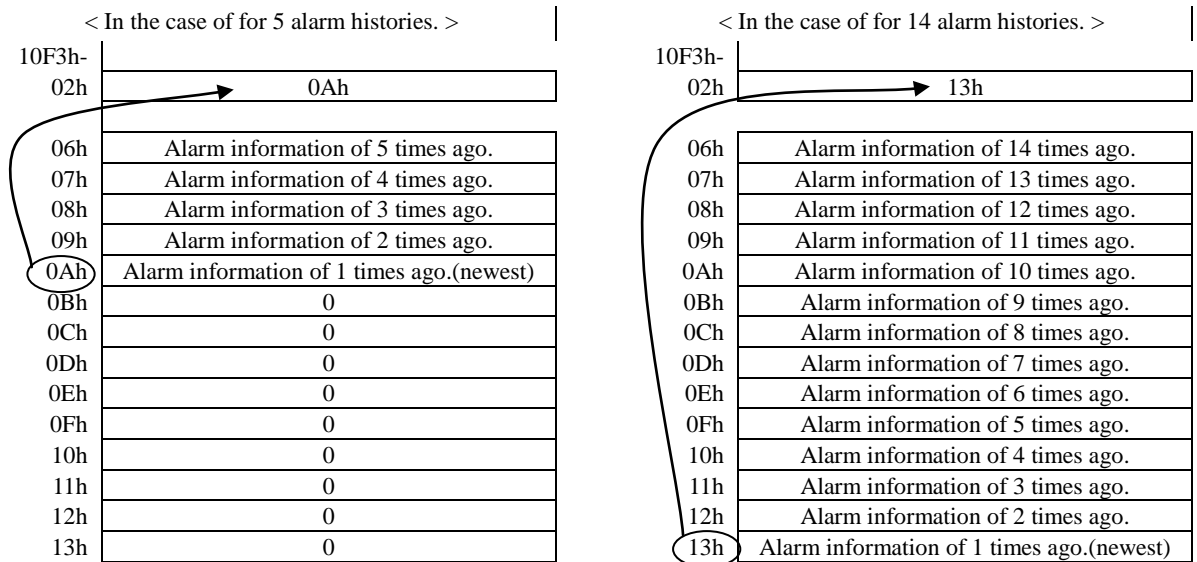

Index	Sub-Index	Name / Description	Units	Range	Data Type	Access	PDO	Op-mode	EEPROM																																																																					
10F3h	-	Diagnosis history Reads an error history and enables/disables an emergency message.	-	-	-	-	-	-	-																																																																					
	00h	Number of entries Represents the number of sub-indexes for this object. The value is fixed at 13h.	-	0 - 255	U8	ro	No	ALL	No																																																																					
	01h	Maximum messages - Represents the number of error messages which this servo amplifier is possible to store. The value is fixed at 0Eh. (14times)	-	0 - 255	U8	ro	No	ALL	No																																																																					
	02h	Newest message - Displays the sub-index where the latest error message is stored. - Indicates 0 when there is no alarm history such as immediately after the alarm history is cleared.	-	0 - 255	U8	ro	No	ALL	No																																																																					
	03h	Newest acknowledged message Read : always 0 Write : writing of 00h : All the Diagnosis Message clearances writing of other than 00h : Output of SDO Abort (Code 0x06090030)	-	0 - 255	U8	rw	No	ALL	No																																																																					
	04h	New messages available It does not support with this servo amplifier. The value is fixed at 0.	-	0 - 1	BOOL	ro	No	ALL	No																																																																					
	05h	Flags <table border="1" style="width: 100%; border-collapse: collapse;"> <tr> <td style="width: 10%;">bit 0</td> <td style="width: 5%;">RW</td> <td>Emergency messages execution permission 0 : Emergency message Invalid 1 : Whenever new abnormality is detected, emergency message is issued. (Some of the anomaly does not remain in the Diagnosis message) For the detail of the emergency message, refer to Section 3-6-1.</td> </tr> <tr> <td>bit 1</td> <td>R</td> <td>Not supported : Fixed at 1</td> </tr> <tr> <td>bit 2</td> <td>R</td> <td>Not supported : Fixed at 1</td> </tr> <tr> <td>bit 3</td> <td>R</td> <td>Not supported : Fixed at 0</td> </tr> <tr> <td>bit 4</td> <td>R</td> <td>Not supported : Fixed at 0</td> </tr> <tr> <td>bit 5</td> <td>R</td> <td>Diagnosis message clearances information 1 : Clearance of diagnosis message is completed. (at the time of 10F3h-03h=0 writing) (The value is kept until new error (alarm) occurs)</td> </tr> <tr> <td>bit 6-15</td> <td>-</td> <td>Reservation</td> </tr> </table>	bit 0	RW	Emergency messages execution permission 0 : Emergency message Invalid 1 : Whenever new abnormality is detected, emergency message is issued. (Some of the anomaly does not remain in the Diagnosis message) For the detail of the emergency message, refer to Section 3-6-1.	bit 1	R	Not supported : Fixed at 1	bit 2	R	Not supported : Fixed at 1	bit 3	R	Not supported : Fixed at 0	bit 4	R	Not supported : Fixed at 0	bit 5	R	Diagnosis message clearances information 1 : Clearance of diagnosis message is completed. (at the time of 10F3h-03h=0 writing) (The value is kept until new error (alarm) occurs)	bit 6-15	-	Reservation	-	0 - 65535	U16	rw	No	ALL	Yes																																																
	bit 0	RW	Emergency messages execution permission 0 : Emergency message Invalid 1 : Whenever new abnormality is detected, emergency message is issued. (Some of the anomaly does not remain in the Diagnosis message) For the detail of the emergency message, refer to Section 3-6-1.																																																																											
	bit 1	R	Not supported : Fixed at 1																																																																											
	bit 2	R	Not supported : Fixed at 1																																																																											
bit 3	R	Not supported : Fixed at 0																																																																												
bit 4	R	Not supported : Fixed at 0																																																																												
bit 5	R	Diagnosis message clearances information 1 : Clearance of diagnosis message is completed. (at the time of 10F3h-03h=0 writing) (The value is kept until new error (alarm) occurs)																																																																												
bit 6-15	-	Reservation																																																																												
06h	Diagnosis message 1 An error history is displayed. <table border="1" style="width: 100%; border-collapse: collapse;"> <tr> <td style="width: 10%;">Example:</td> <td>00</td><td>E8</td><td>10</td><td>FF</td><td>02</td><td>00</td><td>00</td><td>00</td><td>00</td><td>00</td><td>00</td><td>00</td><td>00</td><td>00</td><td>00</td><td>00</td><td>00</td> </tr> <tr> <td>Application</td> <td>(L)</td><td>(H)</td><td>(L)</td><td>(H)</td><td>(L)</td><td>(H)</td><td>(L)</td><td>(H)</td><td>(L)</td><td colspan="7">(Fixed value)</td><td>(H)</td> </tr> <tr> <td></td> <td colspan="4">(Fixed value)</td> <td colspan="2">Error Code</td> <td colspan="2">(Fixed value)</td> <td colspan="2">Text ID</td> <td colspan="7">(Fixed value)</td> </tr> <tr> <td></td> <td colspan="4">Diag Code</td> <td colspan="2">Flags</td> <td colspan="2">Text ID</td> <td colspan="7">Time stamp</td> </tr> </table> Diag Code ... Diagnostic code which identifies a message The value of 603Fh returns to ErrorCode. Flags ... The value is fixed at 00002h. Text ID ... Text ID is defined for each error messages(Error code). Main alarm number is set as upper 8 bits, and a sub alarm number is set as lower 8 bits. Time stamp ... Time when abnormalities were notified Not supported : The value is fixed at 0000000000000000h.	Example:	00	E8	10	FF	02	00	00	00	00	00	00	00	00	00	00	00	00	Application	(L)	(H)	(L)	(H)	(L)	(H)	(L)	(H)	(L)	(Fixed value)							(H)		(Fixed value)				Error Code		(Fixed value)		Text ID		(Fixed value)								Diag Code				Flags		Text ID		Time stamp							-	-	VS	ro	No	ALL	No (*1)
Example:	00	E8	10	FF	02	00	00	00	00	00	00	00	00	00	00	00	00																																																													
Application	(L)	(H)	(L)	(H)	(L)	(H)	(L)	(H)	(L)	(Fixed value)							(H)																																																													
	(Fixed value)				Error Code		(Fixed value)		Text ID		(Fixed value)																																																																			
	Diag Code				Flags		Text ID		Time stamp																																																																					
:	:	:	:	:	:	:	:	:	:																																																																					
13h	Diagnosis message 14 An error history is displayed. The content is same as the sub-index 06h.	-	-	VS	ro	No	ALL	No (*1)																																																																						

(*1) Although not backed up as an object, it is transmitted from the alarm information backed up separately.

6 Drive Profile Area (6000h to 6FFFh)

6-1 Object List.....	72
6-2 PDS (Power Drive Systems) Specification	74
6-2-1 Finite State Automaton (FSA)	74
6-3 Controlword (6040h).....	76
6-4 Statusword (6041h).....	78
6-5 Operation mode Setting.....	80
6-5-1 Supported Drive Modes (6502h)	80
6-5-2 Modes of Operation (6060h).....	81
6-5-3 Modes of Operation Display (6061h)	82
6-5-4 Precautions for Changing Operation mode	83
6-6 Position Control Function(pp,csp,ip,hm)	84
6-6-1 Common Position Control Function	84
1) Position control block diagram	84
2) Related objects common in position control (command & setup)	86
- Position system	87
- Velocity system	87
- Torque system	87
- Acceleration and deceleration system	88
- Software position limit (607Dh).....	89
3) Related objects common in position control (monitoring).....	91
- Position system	92
- Velocity system	92
- Torque system	92
- Statusword (6041h) <Common functions in position control>	93
6-6-2 Profile Position mode (pp mode)	96
1) Objects related to pp mode (command & setup).....	97
- Controlword (6040h) <Functions in pp mode>	99
- Positioning option code (60F2h)	101
2) Objects related to pp mode (monitoring)	104
- Statusword (6041h) <Functions in pp mode>	105
3) Operations of pp mode.....	106
- Example 1 (basic set-point)	106
- Example 2 (Data change in operation, without buffer: Single set-point)	107
- Example 3 (Data change in operation, with buffer: Set of set-points).....	108
- Example 4 (Buffering of set-points)	109
- Example 5 (Temporary stop by halt)	110
6-6-3 Cyclic Position Mode (csp mode).....	111
1) Objects related to csp mode (command & setup)	112
- Controlword (6040h) <Functions in csp mode>.....	114
- Position system	114
2) Objects related to csp mode (monitoring).....	115
- Statusword (6041h) <Functions in csp mode>	116
3) Operations of csp mode	117
4) Calibration process on the occurrence of communication error.....	118
5) Amount of change saturation function of command position	119
6-6-4 Interpolating Position Mode (ip mode) (Not supported).....	121

6-6-5 Homing Position Mode (hm mode)	122
1) Objects related to hm mode (command & setup).....	123
- Controlword (6040h) <Functions in hm mode>	125
- Homing method (6098h)	126
- Homing speeds (6099h).....	127
- Homing acceleration (609Ah)	127
2) Objects related to hm mode (monitoring)	128
- Statusword (6041h) <Functions in hm mode>	129
- Supported homing method (60E3h).....	130
3) Operations of hm mode (Homing operation)	131
- Homing error occur conditions	133
- Method 1.....	134
- Method 2.....	135
- Method 3, 4.....	136
- Method 5, 6.....	137
- Method 7, 8, 9, 10.....	138
- Method 11, 12, 13, 14.....	139
- Method 17.....	140
- Method 18.....	141
- Method 19, 20.....	142
- Method 21, 22.....	143
- Method 23, 24, 25, 26.....	144
- Method 27, 28, 29, 30.....	145
- Method 33, 34.....	146
- Method 35, 37.....	147
6-7 Velocity Control Function.....	148
6-7-1 Common Velocity Control Function.....	148
1) Velocity control block diagram.....	148
2) Related objects common in velocity control (command & setup)	149
- Velocity system	150
- Torque system	150
3) Related objects common in velocity control (monitoring).....	151
- Position system	152
- Velocity system	152
- Torque system	152
6-7-2 Profile Velocity Mode (pv mode).....	153
1) Objects related to pv mode (command & setup).....	154
- Controlword (6040h) <Functions in pv mode>	156
- Velocity system	157
- Acceleration and deceleration system	157
2) Objects related to pv mode (monitoring)	158
- Statusword (6041h) <Functions in pv mode>	159
3) Operations of pv mode.....	162
6-7-3 Cyclic Velocity Mode (csv mode)	163
1) Objects related to csv mode (command & setup)	164
- Controlword (6040h) <Functions in csv mode>.....	165
2) Objects related to csv mode (monitoring).....	166
- Statusword (6041h) <Functions in csv mode>	167
3) Operations of csv mode	168

6-8 Torque Control Function.....	169
6-8-1 Common Torque Control Function.....	169
1) Torque control block diagram.....	169
2) Related objects common in torque control (command & setup).....	170
- Velocity system	171
- Torque system	171
3) Related objects common in torque control (monitoring)	172
- Position system	173
- Velocity system	173
- Torque system	173
6-8-2 Profile Torque Mode (tq mode)	174
1) Objects related to tq mode (command & setup).....	175
- Controlword (6040h) <Functions in tq mode>	176
- Torque system	177
2) Related objects (monitoring).....	178
- Statusword (6041h) <Functions in tq mode>	179
- Torque system	179
3) Operations of tq mode.....	180
6-8-3 Cyclic Torque Mode (cst mode)	181
1) Objects related to cst mode (command & setup)	182
- Controlword (6040h) <Functions in cst mode>.....	183
2) Objects related to cst mode (monitoring).....	184
- Statusword (6041h) <Functions in cst mode>	185
3) Operations of cst mode	186
6-9 Common Motion Function.....	187
6-9-1 Touch Probe Function (position latch request/release)	187
1) Configuration of touch probe function.....	188
2) Touch probe relevant object.....	189
3) Touch probe function (60B8h).....	190
4) Touch probe status (60B9h).....	191
5) Touch probe position 1/2 positive value (60BAh - 60BDh)	192
6) Starting touch probe operation.....	193
7) Event mode of touch probe	194
6-9-2 Option Code (deceleration stop sequence).....	196
1) Abort connection option code(6007h)	198
2) Quick stop option code(605Ah)	201
3) Shutdown option code(605Bh)	203
4) Disable operation option code (605Ch)	205
5) Halt option code (605Dh)	206
6) Fault reaction option code (605Eh).....	207
7) Sequence at drive inhibition input (POT, NOT)	208
6-9-3 Digital Inputs/Digital Outputs.....	209
1) Digital inputs (60FDh)	210
2) Digital outputs (60FEh)	211
6-9-4 Position information	213
1) Initialization timing of position information.....	213
2) Electronic Gear Function	214
3) Polarity(607Eh).....	218
4) Initialization of the absolute encoder	220
5) Position range limit (607Bh).....	224
6) Home offset (607Ch)	225
6-9-5 Jerk.....	226
6-9-6 Interpolation time period (60C2h)	227

6-1 Object List

Index	Sub-Index	Name
6007h	00h	Abort connection option code
603Fh	00h	Error code
6040h	00h	Controlword
6041h	00h	Statusword
605Ah	00h	Quick stop option code
605Bh	00h	Shutdown option code
605Ch	00h	Disable operation option code
605Dh	00h	Halt option code
605Eh	00h	Fault reaction option code
6060h	00h	Modes of operation
6061h	00h	Modes of operation display
6062h	00h	Position demand value
6063h	00h	Position actual internal value
6064h	00h	Position actual value
6065h	00h	Following error window
6066h	00h	Following error time out
6067h	00h	Position window
6068h	00h	Position window time
6069h	00h	Velocity sensor actual value
606Ah	00h	Sensor selection code
606Bh	00h	Velocity demand value
606Ch	00h	Velocity actual value
606Dh	00h	Velocity window
606Eh	00h	Velocity window time
606Fh	00h	Velocity threshold
6070h	00h	Velocity threshold time
6071h	00h	Target torque
6072h	00h	Max torque
6073h	00h	Max current
6074h	00h	Torque demand
6075h	00h	Motor rated current

Index	Sub-Index	Name
6076h	00h	Motor rated torque
6077h	00h	Torque actual value
6078h	00h	Current actual value
6079h	00h	DC link circuit voltage
607Ah	00h	Target position
607Bh	-	Position range limit
	00h	Highest sub-index supported
	01h	Min position range limit
	02h	Max position range limit
607Ch	00h	Home offset
607Dh	-	Software position limit
	00h	Number of entries
	01h	Min position limit
	02h	Max position limit
607Eh	00h	Polarity
607Fh	00h	Max profile velocity
6080h	00h	Max motor speed
6081h	00h	Profile velocity
6082h	00h	End velocity
6083h	00h	Profile acceleration
6084h	00h	Profile deceleration

Index	Sub-Index	Name
6085h	00h	Quick stop deceleration
6086h	00h	Motion profile type
6087h	00h	Torque slope
6088h	00h	Torque profile type
608Fh	-	Position encoder resolution
	00h	Highest sub-index supported
	01h	Encoder increments
	02h	Motor revolutions
6091h	-	Gear ratio
	00h	Number of entries
	01h	Motor revolutions
	02h	Shaft revolutions
6092h	-	Feed constant
	00h	Highest sub-index supported
	01h	Feed
	02h	Shaft revolutions
6098h	00h	Homing method
	-	Homing speeds
6099h	00h	Number of entries
	01h	Speed during search for switch
	02h	Speed during search for zero
609Ah	00h	Homing acceleration
60A3h	00h	Profile jerk use
60A4h	-	Profile jerk
	00h	Highest sub-index supported
	01h	Profile jerk 1
	02h	Profile jerk 2
60B0h	00h	Position offset
60B1h	00h	Velocity offset
60B2h	00h	Torque offset
60B8h	00h	Touch probe function
60B9h	00h	Touch probe status
60BAh	00h	Touch probe pos1 pos value
60BBh	00h	Touch probe pos1 neg value
60BCh	00h	Touch probe pos2 pos value
60BDh	00h	Touch probe pos2 neg value
60C0h	00h	Interpolation sub mode select

Index	Sub-Index	Name
60C1h	-	Interpolated data record
	00h	Highest sub-index supported
	01h	1 st set-point
	to	-
	FEh	254th set-point
60C2h	-	Interpolation time period
	00h	Highest sub-index supported
	01h	Interpolation time period value
	02h	Interpolation time index
60C4h	-	Interpolation data configuration
	00h	Highest sub-index supported
	01h	Maximum buffer size
	02h	Actual buffer size
	03h	Buffer organisation
	04h	Buffer position
	05h	Size of data record
	06h	Buffer clear
60C5h	00h	Max acceleration
60C6h	00h	Max deceleration
60E3h	-	Supported homing method
	00h	Number of entries
	01h	1 st supported homing method
	to	-
	FEh	254th supported homing method
60F2h	00h	Positioning option code
60F4h	00h	Following error actual value
60FAh	00h	Control effort
60FCh	00h	Position demand internal value
60FDh	00h	Digital inputs
60FEh	-	Digital outputs
	00h	Number of entries
	01h	Physical outputs
	02h	Bit mask
60FFh	00h	Target velocity
6502h	00h	Supported drive modes

6-2 PDS (Power Drive Systems) Specification

6-2-1 Finite State Automaton (FSA)

The figure below defines state transition(FSA) of PDS related to the power control triggered by the user command or error detection etc..(After that, describe “PDS state” in this document.)

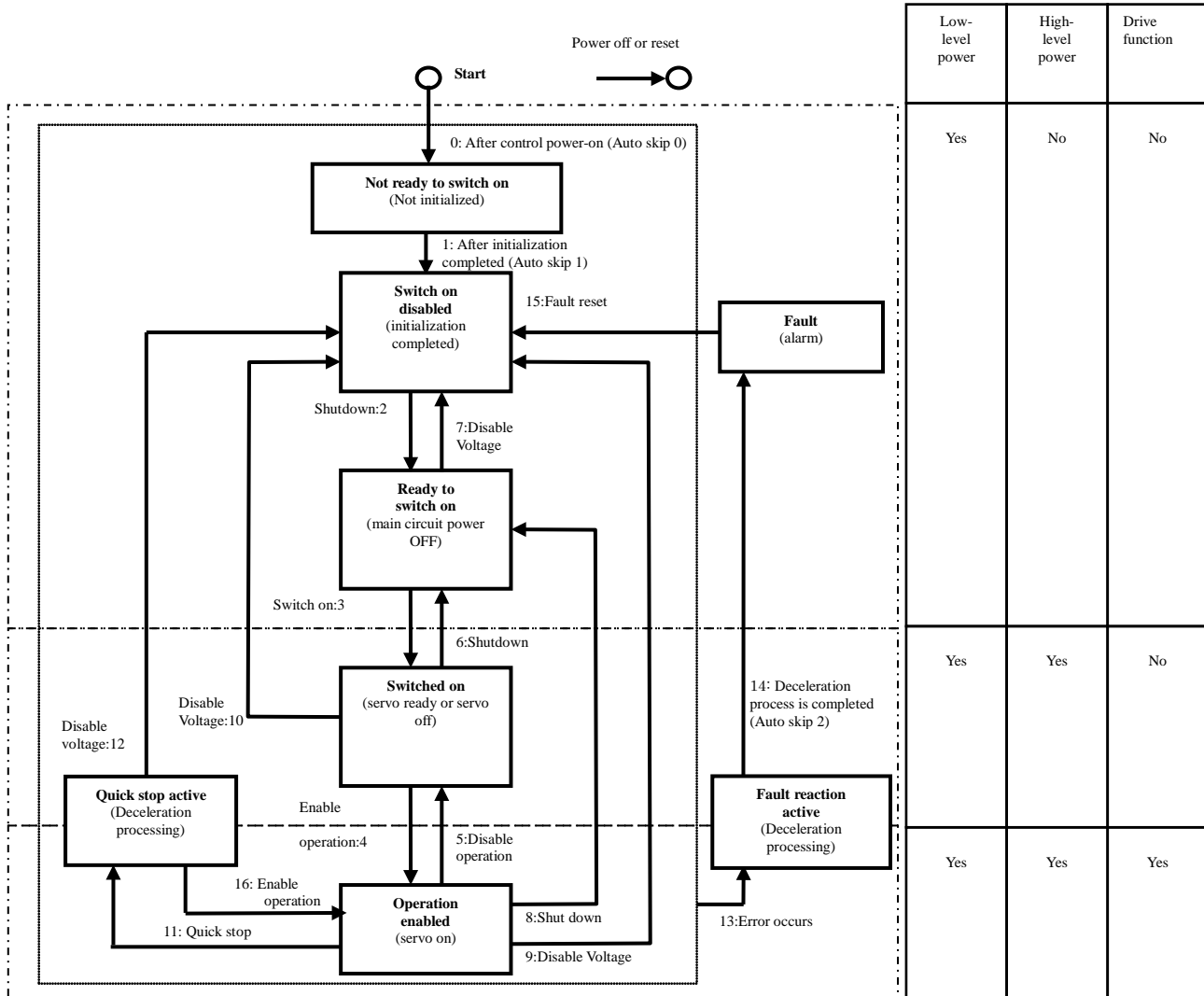

Low-level power: control power supply
 High-level power: main power supply
 Drive function: servo-on

The conditions of a servo ready state are that High-level power(main power supply) is in the state of ON. When High-level power (main power supply) is in the state of OFF, it does not become servo ready and can not transition to the state Switched on.

After transition to Operation enabled(servo on), perform an operation reaction command after time for 100ms or more.

PDS state transition events(transition condition) and actions are listed in the table below.

PDS transition must be performed while handshaking with transition status.

(Next transition command must be sent after checking at 6041h:statusword that transition has completed.)

PDS Transition		Event(s)	Action(s)
0	Auto skip 0	- Automatically changes after control power-on or after resetting application	- The drive functions are self-diagnosed and initialized.
1	Auto skip 1	- Automatic transition after the completion of initialization.	- The communication is established.
2	Shutdown	- The Shutdown command is received	- Nothing in particular
3	Switch on	- In the state of ON of High-level power, The Switch-on command is received	- Nothing in particular
4	Enable operation	- The Enable operation command is received	- The drive functions are validated. Also, all the set point data is cleared.
5	Disable operation	- The Disable operation command is received	- The drive functions are disabled.
6	Shutdown	- In the state of ON of High-level power, The Shutdown command is received - When High-level power detects the state of OFF.	- Nothing in particular
7	Disable voltage	- The Disable voltage command is received. - The Quick stop command is received. - The state transitions to Init when the ESM state is PreOP, SafeOP, or OP	- Nothing in particular
8	Shutdown	- In the state of ON of High-level power, The Shutdown command is received	- The drive functions are disabled.
9	Disable voltage	- The Disable voltage command is received - The OFF state of High-level power is detected when the value of Abort connection option code is 2	- The drive functions are disabled.
10	Disable voltage	- The Disable voltage command is received. - The Quick stop command is received. - The state transitions to Init when the ESM state is PreOP, SafeOP, or OP	- Nothing in particular
11	Quick stop	- The Quick stop command is received - The OFF state of High-level power is detected when the value of Abort connection option code is 3	- The Quick stop function starts.
12	Disable voltage	- Quick stop function is completed and quick stop option code is 1, 2 or 3. - After Quick stop function is completed, received Disable voltage command quick stop option code is 5, 6, or 7. - High-level power OFF is detected.	- The drive functions are disabled.
13	Error occurs	- An error is detected - The OFF state of High-level power is detected when the value of Abort connection option code is 1	- Performs the established Fault reaction function.
14	Auto skip 2	- After completing the deceleration process due to an error detection, the state transitions automatically	- The drive functions are disabled.
15	Fault reset	- After releasing factor error, The Fault reset command is received	- Resets the Fault state when there is no Fault factor.
16	Enable operation	- When the Quick stop option code is 5, 6, 7, or 8 and when the Enable operation command is received	- The drive functions are validated.

6-3 Controlword (6040h)

Use the object 6040h (Control word) to set the commands to control a slave (servo amplifier) including the PDS state transition.

(SAFETY PRECAUTIONS)
 When using this object, be sure to use the PDO and enable the PDO watchdog.
 SDO cannot judge communication cut-off, therefore an electricity state of the motor might be continued and becomes non-safe..

Index	Sub-Index	Name / Description	Units	Range	Data Type	Access	PDO	Op-mode	EEPROM																																	
6040h	00h	Controlword • Set a command to a servo amplifier including the PDS state transition.	-	0 - 65535	U16	rw	RxPDO	ALL	No																																	
		bit information details																																								
		<table border="1" style="width: 100%; text-align: center;"> <tr> <td>15</td><td>14</td><td>13</td><td>12</td><td>11</td><td>10</td><td>9</td><td>8</td><td>7</td><td>6</td><td>5</td><td>4</td><td>3</td><td>2</td><td>1</td><td>0</td> </tr> <tr> <td colspan="6">r</td> <td>oms</td> <td>h</td> <td>fr</td> <td colspan="3">oms</td> <td>eo</td> <td>qs</td> <td>ev</td> <td>so</td> </tr> </table>	15	14	13	12	11	10	9	8	7	6	5	4	3	2	1	0	r						oms	h	fr	oms			eo	qs	ev	so								
15	14	13	12	11	10	9	8	7	6	5	4	3	2	1	0																											
r						oms	h	fr	oms			eo	qs	ev	so																											
		r = reserved (not supported), oms = operation mode specific (operation mode dependent bit), h = halt fr = fault reset eo = enable operation qs = quick stop ev = enable voltage so = switch on																																								

bit7,3-0 (fault reset / enable operation / quick stop / enable voltage / switch on):

Indicates the PDS command. Here, describes the combination of bits corresponding to the command:

-: Indefinite

Command	Bits of the controlword					Transitions
	bit 7	bit 3	bit 2	bit 1	bit 0	
	fault reset	enable operation	quick stop	enable voltage	switch on	
Shutdown	0	-	1	1	0	2,6,8
Switch on	0	0	1	1	1	3
Switch on + enable operation	0	1	1	1	1	3+4 (*1)
Enable operation	0	1	1	1	1	4, 16
Disable voltage	0	-	-	0	-	7, 9, 10, 12
Quick stop	0	-	0 (*2)	1	-	7,10, 11
Disable operation	0	0	1	1	1	5
Fault reset		-	-	-	-	15

(*1) Automatic transition to Enable operation state after executing "switch on" state functionality.
 (*2) "Quick stop" command is enabled if the bit is '0'.
 Please keep in mind that the bit performs reverse operation compared to other bits.

bit8(halt):

If 1, the motor is decelerated and stopped temporarily according to 605Dh (Halt option code).

After the motor stops, restoring the bit to 0 resumes the operation.

In the hm control mode, however, operation is not restarted even if the bit is restored to 0 after the stop by 1.

bit9,6-4 (operation mode specific):

Below table shows the behavior of the operation mode(Op-mode) specific bits.

(For details, refer to the relevant object's section of each operation mode.)

-: not used(Set to 0)

Op-mode	bit9	bit6	bit5	bit4
pp	change on set-point	absolute / relative	change set immediately	new set-point
pv	-	-	-	-
tq	-	-	-	-
hm	-	-	-	start homing
ip	-	-	-	enable interpolation
csp	-	-	-	-
csv	-	-	-	-
cst	-	-	-	-

6-4 Statusword (6041h)

Use the object 6041h (Status word) to check a slave (servo amplifier) state.

Index	Sub-Index	Name / Description	Units	Range	Data Type	Access	PDO	Op-mode	EEPROM																																		
6041h	00h	Statusword • Displays the servo amplifier state. bit information details	-	0 - 65535	U16	ro	RxPDO	ALL	No																																		
		<table border="1"> <thead> <tr> <th>15</th><th>14</th><th>13</th><th>12</th><th>11</th><th>10</th><th>9</th><th>8</th><th>7</th><th>6</th><th>5</th><th>4</th><th>3</th><th>2</th><th>1</th><th>0</th> </tr> </thead> <tbody> <tr> <td>r</td><td></td><td>oms</td><td></td><td>ila</td><td>oms</td><td>rm</td><td>r</td><td>w</td><td>sod</td><td>qs</td><td>ve</td><td>f</td><td>oe</td><td>so</td><td>rtso</td> </tr> </tbody> </table> r = reserved (not supported), oms = operation mode specific (operation mode dependent bit), ila = internal limit active rm = remote w = warning sod = switch on disabled qs = quick stop ve = voltage enabled f = fault oe = operation enabled so = switched on rtso = ready to switch on	15	14	13	12	11	10	9	8	7	6	5	4	3	2	1	0	r		oms		ila	oms	rm	r	w	sod	qs	ve	f	oe	so	rtso									
15	14	13	12	11	10	9	8	7	6	5	4	3	2	1	0																												
r		oms		ila	oms	rm	r	w	sod	qs	ve	f	oe	so	rtso																												

bit6,5,3-0 (switch on disabled / quick stop / fault / operation enable / switched on / ready to switch on):

This bit enables to confirm the PDS state. The table below lists the states and corresponding bits:

Statusword	PDS state	
xxxx xxxx x0xx 0000 b	Not ready to switch on	Initialization non-completed
xxxx xxxx x1xx 0000 b	Switch on disabled	Initialization completed
xxxx xxxx x01x 0001 b	Ready to switch on	Main circuit power OFF
xxxx xxxx x01x 0011 b	Switched on	Servo-off/servo ready
xxxx xxxx x01x 0111 b	Operation enabled	Servo-on
xxxx xxxx x00x 0111 b	Quick stop active	Immediate stop
xxxx xxxx x0xx 1111 b	Fault reaction active	Error (alarm) discriminated
xxxx xxxx x0xx 1000 b	Fault	Error (alarm) state

bit4 (voltage enabled):

If 1, the main circuit power voltage is applied to PDS.

bit5 (quick stop):

If 0, it indicates PDS responds to quick stop request.

Quick stop enabled if the bit is '0'.

Please keep in mind that the bit performs reverse operation compared to other bits.

bit7 (warning):

If 1, it is indicating a warning. The PDS state does not change during the warning,

Also, continues the motor operation.

bit8 (reserved):

This bit is not used (fixed at 0).

bit9 (remote):

If 0 (local), 6040h (Control word) indicates the state of impossible processing.

If 1 (remote), 6040h (Control word) indicates the state of possible processing.

It will be set to 1 if ESM state transitions to over Pre-OP or more.

bit13, 12, 10 (operation mode specific) :

Below table shows the behavior of the operation mode(Op-mode) specific bits.
(For details, refer to the relevant object's section of each operation mode.)

Op-mode	bit13	bit12	bit10
pp	following error	set-point acknowledge	target reached
pv	max slippage error (Not supported)	speed	target reached
tq	-	-	target reached
hm	homing error	homing attained	target reached
ip	-	ip mode active	target reached
csp	following error	drive follows command value	-
csv	-	drive follows command value	-
cst	-	drive follows command value	-

-: not used(Indefinite)



bit11(internal limit active) :

Bit11(internal limit active) of the 6041h(Statusword) is set to 1 when the internal limit factor occurs.

The following indicates the factors at which bit11(internal limit active) of the 6041h(Statusword) is set to 1.

Bit11(internal limit active) of the 6041h(Statusword) is indicate conditions for which be 1 below.

Control mode		Internal limiting factor	Servo on / off state
Position control	pp,csp	Emergency stop *1)	on
		Torque limit	on *2)
		Over-travel inhibition input (POT/NOT)	on / off
		Software limit	on / off
hm	Emergency stop *1)	on	
	Torque limit	on *2)	
Velocity control	pv, csv	Emergency stop *1)	on
		Torque limit	on *2)
		Over-travel inhibition input (POT/NOT)	on / off
Torque control	tq, cst cstca	Emergency stop *1)	on
		Torque limit *3)	on *2)
		Over-travel inhibition input (POT/NOT)	on / off
		Rotational direction setup	on

*1) Excluding a case where torque is not limited even during emergency stop.

*2) The minimum value of the following is the torque limit.

- The sum of 6071h (Target torque) and 60B2h (Torque offset) (Only during torque control (tq, cst))
- 6072h (Max torque)
- 3013h (1st torque limit)
- 3522h (2nd torque limit) (only when 3521h = 2 or 4)

*3) By setting the 3703h(Output setup during torque limit), it is possible to switch the torque limit judgment conditions at the time of torque control.

Index	Sub-Index	Name / Description	Units	Range	Data Type	Access	PDO	Op-mode	EEPROM
3703h	00h	Output setup during torque limit	-	0-1	I16	rw	No	cst tq	Yes
Set up judgment condition of output while torque is limited by torque control. 0 : Turn ON at torque limit including torque command value 1 : Turn ON at torque limit excluding torque command value									

bit15, 14(reserved):

This bit is not used (fixed to 0).

6-5 Operation mode Setting

6-5-1 Supported Drive Modes (6502h)

The 6502h (Supported drive modes) enables to confirm the operation modes (Modes of operation) supported by this servo amplifier.

Index	Sub-Index	Name / Description	Units	Range	Data Type	Access	PDO	Op-mode	EEPROM																																																																															
6502h	00h	Supported drive modes	-	0 - 4294967295	U32	ro	TxPDO	ALL	No																																																																															
<ul style="list-style-type: none"> Displays the supported operation mode(Mode of operation). When the value is 1, the mode is supported. <table border="1"> <thead> <tr> <th>bit</th> <th>31 - 16</th> <th>15 - 10</th> <th>9</th> <th>8</th> <th>7</th> <th>6</th> <th>5</th> <th>4</th> <th>3</th> <th>2</th> <th>1</th> <th>0</th> </tr> </thead> <tbody> <tr> <td>Op-mode</td> <td>ms</td> <td>r</td> <td>cst</td> <td>csv</td> <td>csp</td> <td>ip</td> <td>hm</td> <td>r</td> <td>tq</td> <td>pv</td> <td>vl</td> <td>pp</td> </tr> <tr> <td>Value</td> <td>0····0</td> <td>0····0</td> <td>1</td> <td>1</td> <td>1</td> <td>(0)</td> <td>1</td> <td>0</td> <td>1</td> <td>1</td> <td>0</td> <td>1</td> </tr> </tbody> </table> <p>ms : manufacturer-specific r : reserved</p> <table border="1"> <thead> <tr> <th>bit</th> <th>Modes of operation</th> <th>Abbreviation</th> <th>Support *1)</th> </tr> </thead> <tbody> <tr> <td>0</td> <td>Profile position mode</td> <td>pp</td> <td>Yes</td> </tr> <tr> <td>1</td> <td>Velocity mode</td> <td>vl</td> <td>No</td> </tr> <tr> <td>2</td> <td>Profile velocity mode</td> <td>pv</td> <td>Yes</td> </tr> <tr> <td>3</td> <td>Torque profile mode</td> <td>tq</td> <td>Yes</td> </tr> <tr> <td>5</td> <td>Homing mode</td> <td>hm</td> <td>Yes</td> </tr> <tr> <td>6</td> <td>Interpolated position mode</td> <td>ip</td> <td>No</td> </tr> <tr> <td>7</td> <td>Cyclic synchronous position mode</td> <td>csp</td> <td>Yes</td> </tr> <tr> <td>8</td> <td>Cyclic synchronous velocity mode</td> <td>csv</td> <td>Yes</td> </tr> <tr> <td>9</td> <td>Cyclic synchronous torque mode</td> <td>cst</td> <td>Yes</td> </tr> </tbody> </table> <p>*1) Response status is different depending on the software version.</p>										bit	31 - 16	15 - 10	9	8	7	6	5	4	3	2	1	0	Op-mode	ms	r	cst	csv	csp	ip	hm	r	tq	pv	vl	pp	Value	0····0	0····0	1	1	1	(0)	1	0	1	1	0	1	bit	Modes of operation	Abbreviation	Support *1)	0	Profile position mode	pp	Yes	1	Velocity mode	vl	No	2	Profile velocity mode	pv	Yes	3	Torque profile mode	tq	Yes	5	Homing mode	hm	Yes	6	Interpolated position mode	ip	No	7	Cyclic synchronous position mode	csp	Yes	8	Cyclic synchronous velocity mode	csv	Yes	9	Cyclic synchronous torque mode	cst	Yes
bit	31 - 16	15 - 10	9	8	7	6	5	4	3	2	1	0																																																																												
Op-mode	ms	r	cst	csv	csp	ip	hm	r	tq	pv	vl	pp																																																																												
Value	0····0	0····0	1	1	1	(0)	1	0	1	1	0	1																																																																												
bit	Modes of operation	Abbreviation	Support *1)																																																																																					
0	Profile position mode	pp	Yes																																																																																					
1	Velocity mode	vl	No																																																																																					
2	Profile velocity mode	pv	Yes																																																																																					
3	Torque profile mode	tq	Yes																																																																																					
5	Homing mode	hm	Yes																																																																																					
6	Interpolated position mode	ip	No																																																																																					
7	Cyclic synchronous position mode	csp	Yes																																																																																					
8	Cyclic synchronous velocity mode	csv	Yes																																																																																					
9	Cyclic synchronous torque mode	cst	Yes																																																																																					

6-5-2 Modes of Operation (6060h)

The operation mode is set by 6060h (Modes of operation).

Index	Sub-Index	Name / Description	Units	Range	Data Type	Access	PDO	Op-mode	EEPROM																																																				
6060h	00h	Modes of operation	-	-128 - 127	I8	rw	RxPDO	ALL	Yes																																																				
<ul style="list-style-type: none"> Set the operation mode of the servo amplifier. The not supported operation mode cannot be set. <table border="1"> <thead> <tr> <th>Value</th> <th>Modes of operation</th> <th>Abbreviation</th> <th>Support *1)</th> </tr> </thead> <tbody> <tr> <td>-128 - -1</td> <td>Reserved</td> <td>-</td> <td>No</td> </tr> <tr> <td>0</td> <td>No mode change / no mode assigned</td> <td>-</td> <td>Yes</td> </tr> <tr> <td>1</td> <td>Profile position mode</td> <td>pp</td> <td>Yes</td> </tr> <tr> <td>2</td> <td>Velocity mode</td> <td>vl</td> <td>No</td> </tr> <tr> <td>3</td> <td>Profile velocity mode</td> <td>pv</td> <td>Yes</td> </tr> <tr> <td>4</td> <td>Torque profile mode</td> <td>tq</td> <td>Yes</td> </tr> <tr> <td>6</td> <td>Homing mode</td> <td>hm</td> <td>Yes</td> </tr> <tr> <td>7</td> <td>Interpolated position mode</td> <td>ip</td> <td>(No)</td> </tr> <tr> <td>8</td> <td>Cyclic synchronous position mode</td> <td>csp</td> <td>Yes</td> </tr> <tr> <td>9</td> <td>Cyclic synchronous velocity mode</td> <td>csv</td> <td>Yes</td> </tr> <tr> <td>10</td> <td>Cyclic synchronous torque mode</td> <td>cst</td> <td>Yes</td> </tr> <tr> <td>11 - 127</td> <td>Reserved</td> <td>-</td> <td>No</td> </tr> </tbody> </table> <p>*1) Response status is different depending on the software version.</p>										Value	Modes of operation	Abbreviation	Support *1)	-128 - -1	Reserved	-	No	0	No mode change / no mode assigned	-	Yes	1	Profile position mode	pp	Yes	2	Velocity mode	vl	No	3	Profile velocity mode	pv	Yes	4	Torque profile mode	tq	Yes	6	Homing mode	hm	Yes	7	Interpolated position mode	ip	(No)	8	Cyclic synchronous position mode	csp	Yes	9	Cyclic synchronous velocity mode	csv	Yes	10	Cyclic synchronous torque mode	cst	Yes	11 - 127	Reserved	-	No
Value	Modes of operation	Abbreviation	Support *1)																																																										
-128 - -1	Reserved	-	No																																																										
0	No mode change / no mode assigned	-	Yes																																																										
1	Profile position mode	pp	Yes																																																										
2	Velocity mode	vl	No																																																										
3	Profile velocity mode	pv	Yes																																																										
4	Torque profile mode	tq	Yes																																																										
6	Homing mode	hm	Yes																																																										
7	Interpolated position mode	ip	(No)																																																										
8	Cyclic synchronous position mode	csp	Yes																																																										
9	Cyclic synchronous velocity mode	csv	Yes																																																										
10	Cyclic synchronous torque mode	cst	Yes																																																										
11 - 127	Reserved	-	No																																																										

- Since 6060h (Modes of operation) is default = 0 (No mode change/no mode assigned), make sure to set the operation mode value after the power-on.
If the setting value of 6060h changes PDS state to Operation enabled when it is 0, occur Err88.1" Operation mode setting error protection".
- If not supported operation mode is set by SDO, an Abort message is returned as out of range.
- The change of operation mode using 6060h is as follows:
The initial state 6060h=0 (No mode assigned) changes to the supported operation mode (pp, hm, csp, csv, cst, etc.) Then, if 6060h is set to 0, the operation mode is not changed as "No mode changed."
(The operation mode last time is held. For information, refer to section 6-5-4.)

6-5-3 Modes of Operation Display (6061h)

The 6061h (Modes of operation display) enables to confirm the internal operation mode of this servo amplifier.

After setting 6060h (Modes of operation), monitor this object to confirm that the system operation is set as expected.

Index	Sub-Index	Name / Description	Units	Range	Data Type	Access	PDO	Op-Mode	EEPROM																																																				
6061h	00h	Modes of operation display	-	-128 - 127	I8	ro	TxPDO	ALL	No																																																				
<ul style="list-style-type: none"> Displays the operation mode at present. The definition is the same as 6060h (Modes of operation). <table border="1"> <thead> <tr> <th>Value</th> <th>Modes of operation</th> <th>Abbreviation</th> <th>Support *1)</th> </tr> </thead> <tbody> <tr> <td>-128 - -1</td> <td>Reserved</td> <td>-</td> <td>No</td> </tr> <tr> <td>0</td> <td>No mode change / no mode assigned</td> <td>-</td> <td>Yes</td> </tr> <tr> <td>1</td> <td>Profile position mode</td> <td>pp</td> <td>Yes</td> </tr> <tr> <td>2</td> <td>Velocity mode</td> <td>vl</td> <td>No</td> </tr> <tr> <td>3</td> <td>Profile velocity mode</td> <td>pv</td> <td>Yes</td> </tr> <tr> <td>4</td> <td>Torque profile mode</td> <td>tq</td> <td>Yes</td> </tr> <tr> <td>6</td> <td>Homing mode</td> <td>hm</td> <td>Yes</td> </tr> <tr> <td>7</td> <td>Interpolated position mode</td> <td>ip</td> <td>(No)</td> </tr> <tr> <td>8</td> <td>Cyclic synchronous position mode</td> <td>csp</td> <td>Yes</td> </tr> <tr> <td>9</td> <td>Cyclic synchronous velocity mode</td> <td>csv</td> <td>Yes</td> </tr> <tr> <td>10</td> <td>Cyclic synchronous torque mode</td> <td>cst</td> <td>Yes</td> </tr> <tr> <td>11 - 127</td> <td>Reserved</td> <td>-</td> <td>No</td> </tr> </tbody> </table> <p>*1) Response status is different depending on the software version.</p>										Value	Modes of operation	Abbreviation	Support *1)	-128 - -1	Reserved	-	No	0	No mode change / no mode assigned	-	Yes	1	Profile position mode	pp	Yes	2	Velocity mode	vl	No	3	Profile velocity mode	pv	Yes	4	Torque profile mode	tq	Yes	6	Homing mode	hm	Yes	7	Interpolated position mode	ip	(No)	8	Cyclic synchronous position mode	csp	Yes	9	Cyclic synchronous velocity mode	csv	Yes	10	Cyclic synchronous torque mode	cst	Yes	11 - 127	Reserved	-	No
Value	Modes of operation	Abbreviation	Support *1)																																																										
-128 - -1	Reserved	-	No																																																										
0	No mode change / no mode assigned	-	Yes																																																										
1	Profile position mode	pp	Yes																																																										
2	Velocity mode	vl	No																																																										
3	Profile velocity mode	pv	Yes																																																										
4	Torque profile mode	tq	Yes																																																										
6	Homing mode	hm	Yes																																																										
7	Interpolated position mode	ip	(No)																																																										
8	Cyclic synchronous position mode	csp	Yes																																																										
9	Cyclic synchronous velocity mode	csv	Yes																																																										
10	Cyclic synchronous torque mode	cst	Yes																																																										
11 - 127	Reserved	-	No																																																										

6-5-4 Precautions for Changing Operation mode

- The operation mode can be switched by changing the value of 6060h (Modes of operation).
- The 6061h (Modes of operation display) enables to confirm the operation mode of the servo amplifier at present.
- The values of objects that are not supported by the operation mode after a operation mode change are irregular.
- 2 ms is required from the time when the operation mode is changed until the completion of the change. During this time, the value of 6061h and the value of the object of TxPDO related to the operation mode are irregular.
- When selecting another operation mode, wait for at least 2 ms. When several operation modes are repeatedly switched within 2 ms, Err91.1 (command error protection) will occur.
- When switching the operation mode, make sure that the motor is stopped.
If the control mode is changed during a motor operation (including during an origin return operation and deceleration stop), the operation cannot be guaranteed.
The mode may not be changed immediately or Err27.4 (command error protection 1) etc. may occur.
- When 6060h and 6061h are 0 and a PDS state is made to change to "Operation enabled", Err88.1(Operation mode setting error protection) occurs.
- Set the values other than zero to 6060h(Modes of operation) once, when set as 6060h=0 after that, the last operation mode is held.
- If a not supported operation mode is set to 6060h, Err88.1 (Operation mode setting error protection) occurs.
- During the full-closed control, only the position controls are supported. Therefore, during the full-closed control, if 6060h (Modes of operation) is set to 3 (pv), 4(tq), 9 (csv), or 10 (cst), Err88.1 (Operation mode setting error protection) occurs.

6-6 Position Control Function(pp,csp,ip,hm)

6-6-1 Common Position Control Function

1) Position control block diagram

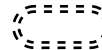
 Monitor data of PANATERM
 Monitor data of CiA402 object

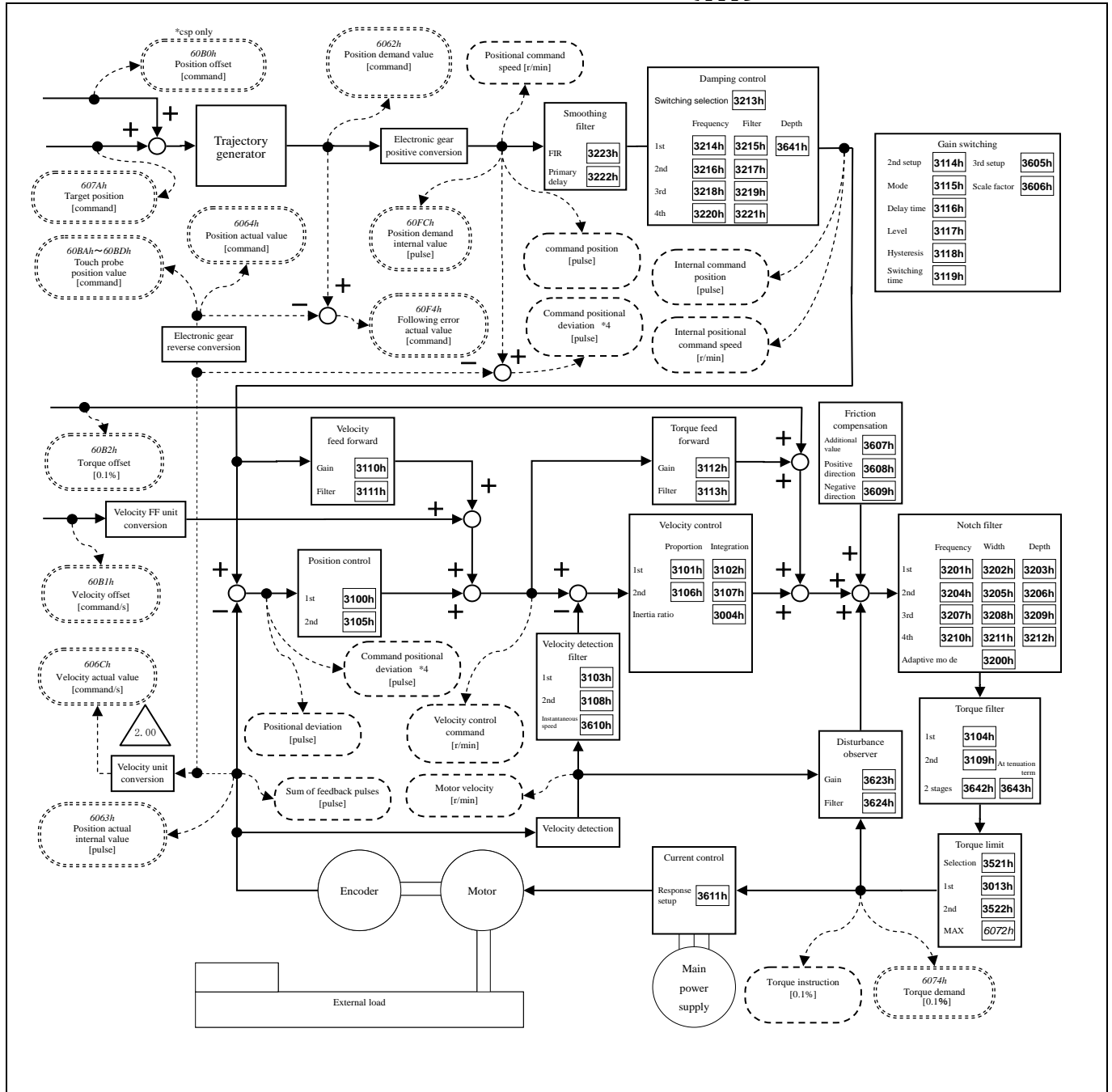

Position control block diagram

 2.00

- *1) A slanting number (ex.:607Ah) shows the object number of EtherCAT.
- *2) A bold letter number (ex.:3100h) shows a parameter number.
- *3) Polarity was omitted.
- *4) The method to calculate the positional deviation on PANATERM and Analog monitor (standard) varies depending on the setting of the command positional deviation output change (bit 14) of 3723h(Communication function extended setup 2). For details, refer to the technical document, basic function specifications (SX-DSV02472), paragraph 3-4.

2.00

In the mode of 2 degrees of freedom control, the structure in the following block diagram is adopted.

Monitor data of PANATERM
 Monitor data of CiA402 object

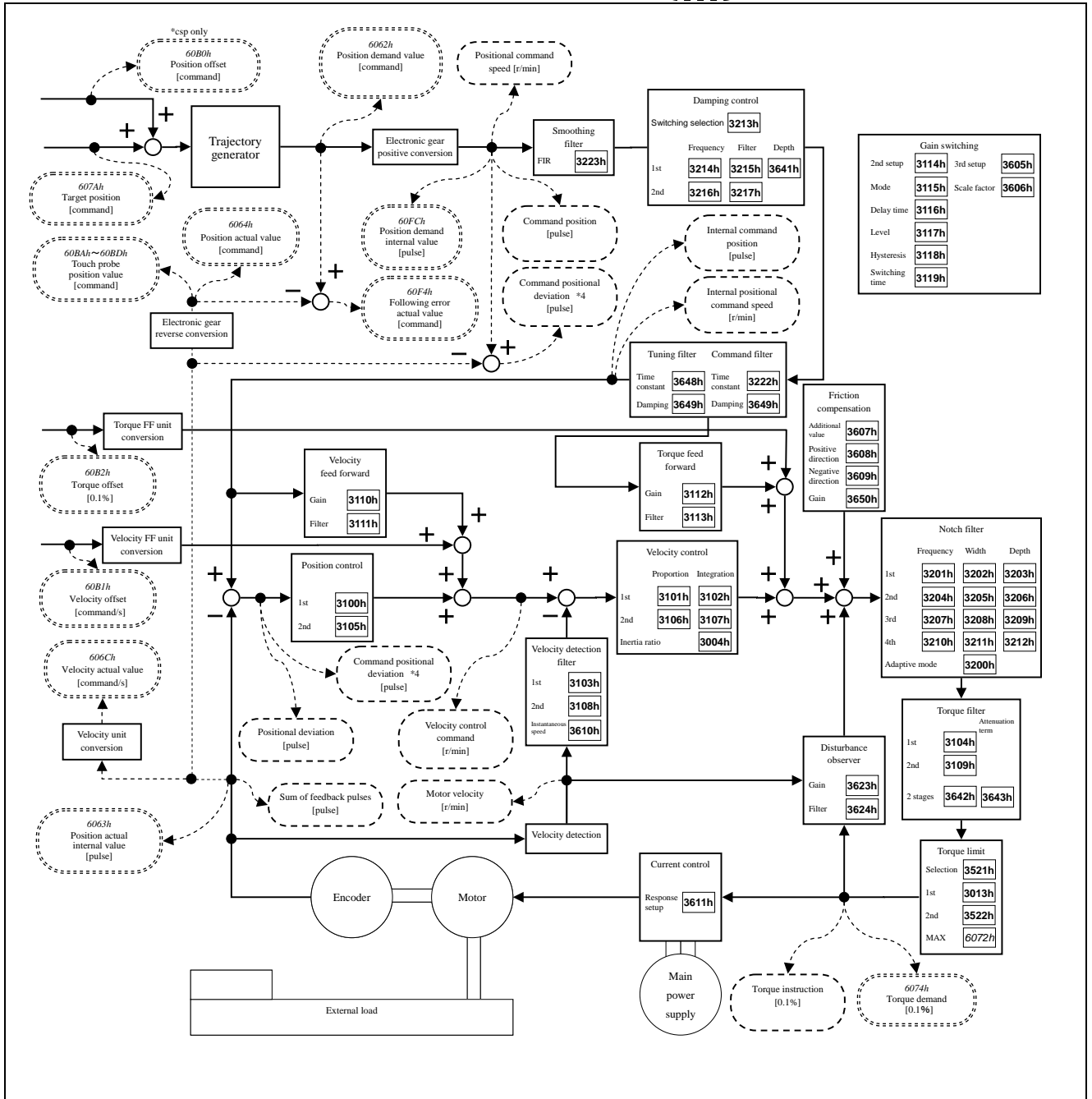

Block diagram of the 2 degrees of freedom control mode

- *1) A slanting number (ex.:607Ah) shows the object number of EtherCAT.
- *2) A bold letter number (ex.:3100h) shows a parameter number.
- *3) Polarity was omitted.
- *4) The method to calculate the positional deviation on PANATERM and Analog monitor (standard) varies depending on the setting of the command positional deviation output change (bit 14) of 3723h(Communication function extended setup 2). For details, refer to the technical document, basic function specifications (SX-DSV02472), paragraph 3-4.

2) Related objects common in position control (command & setup)

Index	Sub-Index	Name	Units	Range	Data Type	Access	PDO	Supported mode			
								pp	csp	ip	hm
6040h	00h	Controlword	-	0 - 65535	U16	rw	RxPDO	Yes	Yes	Yes	Yes
6072h	00h	Max torque	0.1%	0 - 65535	U16	rw	RxPDO	Yes	Yes	Yes	Yes
607Ah	00h	Target position	Command	-2147483648 - 2147483647	I32	rw	RxPDO	Yes	Yes	-	-
607Dh	-	Software position limit	-	-	-	-	-	Yes	Yes	Yes	-
	00h	Number of entries	-	2	U8	ro	No				
	01h	Min position limit	Command	-2147483648 - 2147483647	I32	rw	RxPDO				
	02h	Max position limit	Command	-2147483648 - 2147483647	I32	rw	RxPDO				
607Fh	00h	Max profile velocity	Command/s	0 - 4294967295	U32	rw	RxPDO	Yes	-	Yes	Yes
6080h	00h	Max motor speed	r/min	0 - 4294967295	U32	rw	RxPDO	Yes	Yes	Yes	Yes
6081h	00h	Profile velocity	Command/s	0 - 4294967295	U32	rw	RxPDO	Yes	-	Yes	-
6082h	00h	End velocity	Command/s	0 - 4294967295	U32	rw	RxPDO	Yes	-	Yes	-
6083h	00h	Profile acceleration	Command/s ²	0 - 4294967295	U32	rw	RxPDO	Yes	-	Yes	-
6084h	00h	Profile deceleration	Command/s ²	0 - 4294967295	U32	rw	RxPDO	Yes	-	Yes	-
60B1h	00h	Velocity offset	Command/s	-2147483648 - 2147483647	I32	rw	RxPDO	Yes	Yes	Yes	Yes
60B2h	00h	Torque offset	0.1%	-32768 - 32767	I16	rw	RxPDO	Yes	Yes	Yes	Yes
60C5h	00h	Max acceleration	Command/s ²	0 - 4294967295	U32	rw	RxPDO	Yes	-	Yes	Yes
60C6h	00h	Max deceleration	Command/s ²	0 - 4294967295	U32	rw	RxPDO	Yes	-	Yes	Yes
60F2h	00h	Positioning option code	-	0 - 32767	U16	rw	RxPDO	Yes	-	-	-

- Besides, there are related objects for each operation mode.
Refer to the section "Related objects" of each operation mode.
- The function of 6040h (Control word) can differ according to the operation mode.
Refer to the section "Related objects" of each operation mode.

- Position system

Index	Sub-Index	Name / Description	Units	Range	Data Type	Access	PDO	Op-mode	EEPROM
607Ah	00h	Target position Set the target position.	Command	-2147483648 - 2147483647	I32	rw	RxPDO	pp csp	No

- Velocity system

Index	Sub-Index	Name / Description	Units	Range	Data Type	Access	PDO	Op-mode	EEPROM
607Fh	00h	Max profile velocity • Set the velocity limit. • The maximum value is limited by the internal processing at 6080h(Max motor speed).	Command/s	0 - 4294967295	U32	rw	RxPDO	pp hm ip pv	Yes
6080h	00h	Max motor speed • Set the maximum velocity of motor. Since this servo amplifier automatically sets the value based on the motor information, the setup is not necessary. • The initial value of this servo motor is automatically set from the information. • It is tq and cst and restricts speed with the preset value of this object.	r/min	0 - 4294967295	U32	rw	RxPDO	ALL 	Yes
6081h	00h	Profile velocity • Set the target velocity. • The maximum value is limited by the internal processing at either the smaller 607Fh(Max profile velocity) and 6080h(Max motor speed).	Command/s	0 - 4294967295	U32	rw	RxPDO	pp ip	Yes
6082h	00h	End velocity • Set the end velocity. Because this servo amplifier does not support it, always returns 0.	Command/s	0 - 4294967295	U32	rw	RxPDO	pp ip	Yes
60B1h	00h	Velocity offset • Set the offset of the velocity command (velocity feedforward). • The maximum value is limited by the internal processing at 6080h(Max motor speed).	Command/s	-2147483648 - 2147483647	I32	rw	RxPDO	pp hm ip pv csp csv	Yes

- Torque system

Index	Sub-Index	Name / Description	Units	Range	Data Type	Access	PDO	Op-mode	EEPROM
6072h	00h	Max torque • Set the maximum torque of the motor. • The maximum value is limited by the maximum torque of the motor in the internal processing. • The maximum torque of the motor varies depending on the motor applied.	0.1%	0 - 65535	U16	rw	RxPDO	ALL	Yes
60B2h	00h	Torque offset • Set the offset of the torque command (torque feedforward). • During slowdown in over-travel inhibition(in emergency stop), the torque feedforward level becomes 0. 	0.1%	-32768 - 32767	I16	rw	RxPDO	ALL	Yes

- Acceleration and deceleration system

Index	Sub-Index	Name / Description	Units	Range	Data Type	Access	PDO	Op-mode	EEPROM
6083h	00h	Profile acceleration <ul style="list-style-type: none"> Set the profile acceleration. If it is set to 0, internal processing is treated as 1. 	Command/s ²	0 – 4294967295	U32	rw	RxPDO	pp ip pv	Yes
6084h	00h	Profile deceleration <ul style="list-style-type: none"> Set the profile deceleration. If it is set to 0, internal processing is treated as 1. 	Command/s ²	0 – 4294967295	U32	rw	RxPDO	pp ip pv	Yes
60C5h	00h	Max acceleration <ul style="list-style-type: none"> Set the maximum acceleration. If it is set to 0, internal processing is treated as 1. 	Command/s ²	0 – 4294967295	U32	rw	RxPDO	pp hm pv ip	Yes
60C6h	00h	Max deceleration <ul style="list-style-type: none"> Set the maximum deceleration. If it is set to 0, internal processing is treated as 1. 	Command/s ²	0 – 4294967295	U32	rw	RxPDO	pp hm pv ip	Yes

2.00

- Other

Index	Sub-Index	Name / Description	Units	Range	Data Type	Access	PDO	Op-mode	EEPROM
3724h	00h	Communication function extended setup 3 bit10 : Internal value state selection of objects 60B2h(Torque offset) in servo-off (Fall prevention function in the event of Servo-ON) 0: Clear 1: Updated with the set value of 60B2h	—	-32768 - 32767	I16	rw	No	ALL	Yes

- Software position limit (607Dh)

Set to operation range of positioning command value by 607Dh(Software position limit).

Index	Sub-Index	Name / Description	Units	Range	Data Type	Access	PDO	Op-mode	EEPROM
607Dh	-	Software position limit • Set the software limit value.	-	-	-	-	-	-	-
	00h	Number of entries • Displays the number of sub-indexes for 607Dh (Software position limit).	-	2	U8	ro	No	pp ip csp	No
	01h	Min position limit • Set the software limit value in negative direction.	Command	-2147483648 - 2147483647	I32	rw	RxPDO	pp ip csp	Yes
	02h	Max position limit • Set the software limit value in positive direction.	Command	-2147483648 - 2147483647	I32	rw	RxPDO	pp ip csp	Yes

- Setting unit

607Dh (Software position limit) is set in units of command. Set a value including 607Ch (Home offset) in the same way as 6062h (Position demand value).

For information on Home offset, refer to 6) in Section 6-9-4.

- Activation

To enable the software limit, must satisfy the following conditions.

- That it is the position operation mode (pp, ip, csp).
- That it is position coordinate is finalized.

If the absolute : ESM state is transitioning to more than PreOP.

If the incremental : The return to home position operation has been completed normally.

- That the relationship between the object configuration meets the 607Dh-01h < 607Dh-02h.

Software limit setting is performed at the timing when the ESM status changes from Init to PreOP and at the completion of the return to home position operation.

Note that the setting is not reflected as is even if the setting values for the related objects have been changed.

If it is used in the incremental mode, the software limit function will be ineffective when the ESM status transitions from Init to PreOP, so execute the origin return operation again.

(Note)

At the time of position information initialization, make a setting so that the actual position is within the range of 607Dh-01h to 607Dh-02h (normal operating range).

Except when the actual position is outside of the normal operating range, the actual position can be moved only in the direction in which it falls within the normal operating range. (It cannot be moved in the opposite direction.)

Bit 11 (internal limit active) of 6041h (Statusword) remains 1 until the actual position falls within the normal operating range.

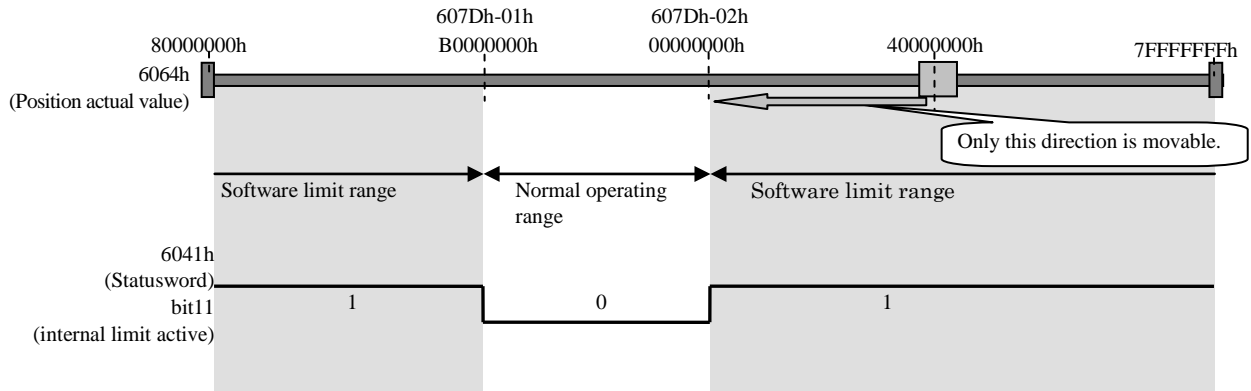

- Invalidation

If disable the software limit function, make the preset value of each object into the following conditions.

$$607Dh-01h \geq 607Dh-02h$$

Example) $607Dh-01h = 0$

$607Dh-02h = 0$

- Workings of wrap around

If want to perform the operation wraparound, please disable software limit function.

If the actual position or command position is wrapped around when the software limit function is effective, Err88.3 (improper operation error protection) will occur. Also bit 11 (internal limit active) of 6041h (Statusword) will be indefinite.

- Workings of limit detection

Upon detection of the actual position or command position reaching the software limit during motor operation, deceleration is started according to quick stop ramp *1).

For the csp control mode, however, deceleration may be started in a delayed fashion depending on the command division timing.

*1) quick stop ramp: 605Ah (Quick option code) set to 2 or 6

3) Related objects common in position control (monitoring)

Index	Sub-Index	Name	Units	Range	Data Type	Access	PDO	Supported mode			
								pp	csp	ip	hm
4D29h	00h	Over load factor	0.1%	0 - 65535	U16	ro	TxPDO	Yes	Yes	Yes	Yes
6041h	00h	Statusword	-	0 - 65535	U16	ro	TxPDO	Yes	Yes	Yes	Yes
6062h	00h	Position demand value	Command	-2147483648 - 2147483647	I32	ro	TxPDO	Yes	Yes	Yes	Yes
6063h	00h	Position actual internal value	pulse	-2147483648 - 2147483647	I32	ro	TxPDO	Yes	Yes	Yes	Yes
6064h	00h	Position actual value	Command	-2147483648 - 2147483647	I32	ro	TxPDO	Yes	Yes	Yes	Yes
6065h	00h	Following error window	Command	0 - 4294967295	U32	rw	RxPDO	Yes	Yes	-	-
6066h	00h	Following error time out	1 ms	0 - 65535	U16	rw	RxPDO	Yes	Yes	-	-
6067h	00h	Position window	Command	0 - 4294967295	U32	rw	RxPDO	Yes	-	Yes	-
6068h	00h	Position window time	1 ms	0 - 65535	U16	rw	RxPDO	Yes	-	Yes	-
6069h	00h	Velocity sensor actual value	-	-2147483648 - 2147483647	I32	ro	TxPDO	Yes	Yes	Yes	Yes
606Ch	00h	Velocity actual value	Command/s	-2147483648 - 2147483647	I32	ro	TxPDO	Yes	Yes	Yes	Yes
6074h	00h	Torque demand	0.1%	-32768 - 32767	I16	ro	TxPDO	Yes	Yes	Yes	Yes
6076h	00h	Motor rated torque	mNm	0 - 4294967295	U32	ro	TxPDO	Yes	Yes	Yes	Yes
6077h	00h	Torque actual value	0.1%	-32768 - 32767	I16	ro	TxPDO	Yes	Yes	Yes	Yes
60F4h	00h	Following error actual value	Command	-2147483648 - 2147483647	I32	ro	TxPDO	Yes	Yes	Yes	Yes
60FAh	00h	Control effort	Command/s	-2147483648 - 2147483647	I32	ro	TxPDO	Yes	Yes	Yes	Yes
60FCh	00h	Position demand internal value	pulse	-2147483648 - 2147483647	I32	ro	TxPDO	Yes	Yes	Yes	Yes

- Besides, there are related objects for each operation mode.
Refer to the section "Related objects" of each operation mode.

- Position system

Index	Sub-Index	Name / Description	Units	Range	Data Type	Access	PDO	Op-mode	EEPROM
6062h	00h	Position demand value	Command	-2147483648 - 2147483647	I32	ro	TxPDO	pp hm ip csp	No
• Indicates a command position (= IPOS).									
6063h	00h	Position actual internal value	pulse	-2147483648 - 2147483647	I32	ro	TxPDO	ALL	No
• Indicate the motor of actual position. If full-close control or encoder unit other than full-closed control, is external scale unit.									
6064h	00h	Position actual value	Command	-2147483648 - 2147483647	I32	ro	TxPDO	ALL	No
• Indicate the motor of actual position(= APOS).									
60F4h	00h	Following error actual value	Command	-2147483648 - 2147483647	I32	ro	TxPDO	pp ip hm csp	No
• Indicate internal deviation(= PERR).									
60FCh	00h	Position demand internal value	pulse	-2147483648 - 2147483647	I32	ro	TxPDO	pp ip hm csp	No
• Indicates an internal command position.									

- Velocity system

Index	Sub-Index	Name / Description	Units	Range	Data Type	Access	PDO	Op-mode	EEPROM
6069h	00h	Velocity sensor actual value	—	-2147483648 - 2147483647	I32	ro	TxPDO	ALL	No
• Indicate sensor value of actual velocity. Return 0 always because this servo amplifier not supported.									
606Ch	00h	Velocity actual value	Command/s	-2147483648 - 2147483647	I32	ro	TxPDO	ALL	No
• Indicate the motor of actual velocity(= FSPD). Note: The maximum value is limited by the 6080h(Max motor speed) in internal processing.									
60FAh	00h	Control effort	Command/s	-2147483648 - 2147483647	I32	ro	TxPDO	pp ip hm csp	No
• Indicate command value of internal velocity(output position loop).									

- Torque system

Index	Sub-Index	Name / Description	Units	Range	Data Type	Access	PDO	Op-mode	EEPROM
4.00	4D29h	Over load factor	0.1%	0 - 65536	U16	ro	TxPDO	ALL	No
• The ratio [0.1%] to the rated load is displayed.									
6074h	00h	Torque demand	0.1%	-32768 - 32767	I16	ro	TxPDO	ALL	No
• Indicates an internal command torque.									
6076h	00h	Motor rated torque	mNm	0 - 4294967295	U32	ro	TxPDO	ALL	No
• Reads out the rated torque from the motor and automatically sets it.									
6077h	00h	Torque actual value	0.1%	-32768 - 32767	I16	ro	TxPDO	ALL	No
• Indicates actual torque. • It becomes a value equivalent to actual current value. • This output value is a reference value and does not guarantee an actual value.									

- Statusword (6041h) <Common functions in position control>

This section describes the following functions of 6041h (Status word).

bit 10: Target reached (completed positioning detected)

bit 13: Following error (position over-deviation detected)

For other functions, refer to the section "Related objects" of each operation mode.

Index	Sub-Index	Name / Description	Units	Range	Data Type	Access	PDO	Op-mode	EEPROM								
6041h	00h	Statusword	-	0 - 65535	U16	ro	TxPDO	ALL	No								
<ul style="list-style-type: none"> Displays the servo amplifier state. 																	
bit information details																	
		15 - 14	13	12	11	10	9	8	7	6	5	4	3	2	1	0	
		oms		ila		target reached (except csp)		rm	r	w	sod	qs	ve	f	oe	so	rtso
		r	following error (only pp,csp)	(differ in operation mode)													
<p>r = reserved (not supported),</p> <p>oms = operation mode specific (operation mode dependent bit),</p> <p>ila = internal limit active</p> <p>rm = remote</p> <p>w = warning</p> <p>sod = switch on disabled</p> <p>qs = quick stop</p> <p>ve = voltage enabled</p> <p>f = fault</p> <p>oe = operation enabled</p> <p>so = switched on</p> <p>rtso = ready to switch on</p>																	

bit10 : target reached (Position reached)

When the servo is on (Operation enable state), all set-points have been released with the command generation completed, the difference between 6062h (Position demand value) and 6064h (Position actual value) is within the range set in 6067h (Position window), and the time set in 6068h (Position window time) elapses, bit 10 (target reached) of 6041h (Statusword) is set to 1.

bit	Name	Value	Definition
10	target reached	0	halt=0 (during normal operation): Positioning not yet completed halt=1 (during stop by halt) : During axis deceleration
		1	halt=0 (during normal operation): Positioning completed halt=1 (during stop by halt) : Axis stop (Axis speed is 0.)

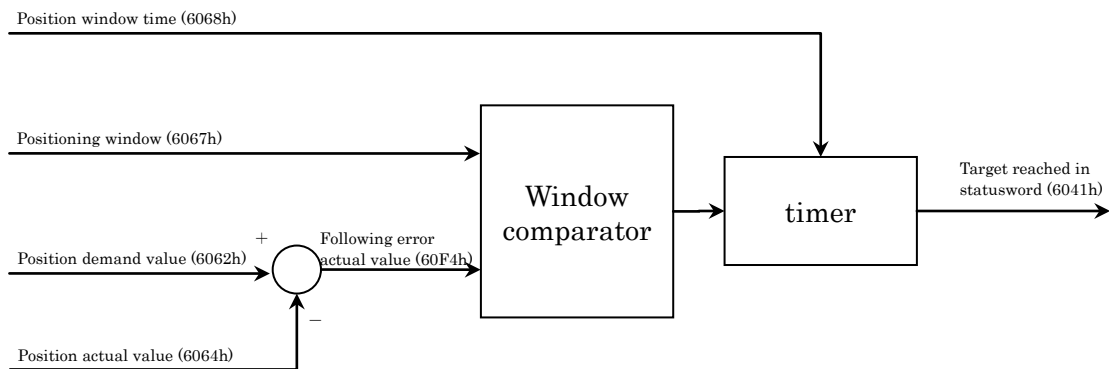

<Position reached (functional overview)>

Index	Sub-Index	Name / Description	Units	Range	Data Type	Access	PDO	Op-mode	EEPROM
6067h	00h	Position window	Command	0 - 4294967295	U32	rw	RxPDO	pp ip	Yes
		<ul style="list-style-type: none"> Set the threshold where bit 10 (Target reached) of 6041h (Statusword) becomes 1 when the difference between 6062h (Position demand value) and 6064h (Position actual value) is within the range set by this parameter and the time set in 6068h (Position window time) elapses. If the position deviation is out of the values set by this parameter, the bit 10 of 6041h will be 0. 							
6068h	00h	Position window time	1 ms	0 - 65535	U16	rw	RxPDO	pp ip	Yes
		<ul style="list-style-type: none"> Set the time until bit 10 of 6041h (Statusword) is turned ON when the difference between 6062h (Position demand value) and 6064h (Position actual value) is within the range set by 6067h (Position window). 							

bit13 : Following error

When the value of 60F4h(Following error actual value) goes beyond the range set by 6065h (Following error window) for the time set by 6066h (Following error time out), the bit 13(Following error) of 6041h (Status word) is set to 1.

bit	Name	Value	Definition
13	following error	0	When 60F4h (Following error actual value) (= 6062h (Position demand value) - 6064h (Position actual value)) does not go beyond the range set by 6065h (Following error window). Or, 60F4h goes beyond the value set by 6065h but the time set by 6066h does not elapse.
		1	60F4h (Following error actual value) goes beyond the range set by 6065h (Following error window) for the time or more set by 6066h (Following error time out)

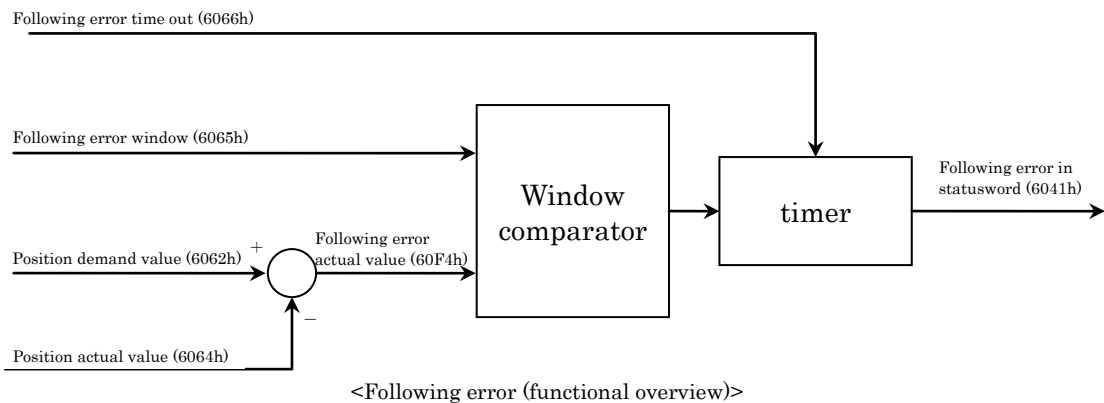

Index	Sub-Index	Name / Description	Units	Range	Data Type	Access	PDO	Op-mode	EEPROM
6065h	00h	Following error window <ul style="list-style-type: none"> Set the threshold where the bit 13 (Following error) of 6041h (Status word) will be 1 when the value of 60F4h(Following error actual value) is out of the values set by this parameter. 	Command	0 - 4294967295	U32	rw	RxPDO	pp csp	Yes
6066h	00h	Following error time out <ul style="list-style-type: none"> If the state which the value of 60F4h(Following error actual value) is exceeded setting range of the 6065h(Following error window) is continued more than setting value of this parameters, bit13(following error) of 6041h(Statusword) set the threshold value is 1. 	1 ms	0 - 65535	U16	rw	RxPDO	pp csp	Yes

6-6-2 Profile Position mode (pp mode)

It is a position control mode to operate by designating the target position, target velocity, addition-subtraction velocity, etc. and creating a position command in the servo amplifier.

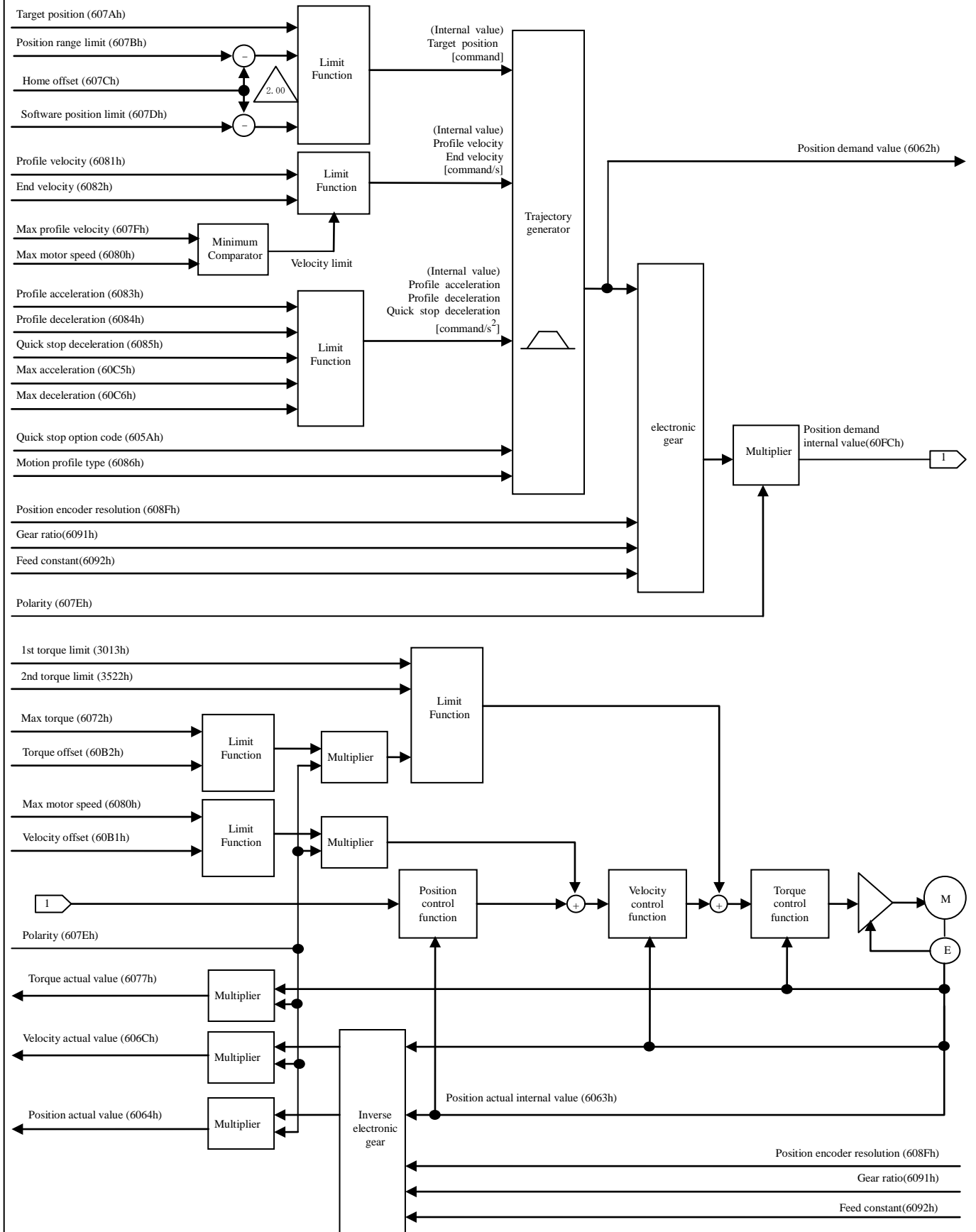

1) Objects related to pp mode (command & setup)







Index	Sub-Index	Name	Units	Range	Data Type	Access	PDO
6040h	00h	Controlword	-	0 - 65535	U16	rw	RxPDO
60F2h	00h	Positioning option code	-	0 - 32767	U16	rw	RxPDO

- Besides, there are related objects common to the position control.

For more information, refer to section 6-6-1.

Index	Sub-Index	Name	Units	Range	Data Type	Access	PDO
6072h	00h	Max torque	0.1%	0 - 65535	U16	rw	RxPDO
607Ah	00h	Target position	Command	-2147483648 - 2147483647	I32	rw	RxPDO
607Dh	-	Software position limit	-	-	-	-	-
	00h	Number of entries	-	2	U8	ro	No
	01h	Min position limit	Command	-2147483648 - 2147483647	I32	rw	RxPDO
	02h	Max position limit	Command	-2147483648 - 2147483647	I32	rw	RxPDO
607Fh	00h	Max profile velocity	Command/s	0 - 4294967295	U32	rw	RxPDO
6080h	00h	Max motor speed	r/min	0 - 4294967295	U32	rw	RxPDO
6081h	00h	Profile velocity	Command/s	0 - 4294967295	U32	rw	RxPDO
6082h	00h	End velocity	Command/s	0 - 4294967295	U32	rw	RxPDO
6083h	00h	Profile acceleration	Command/s ²	0 - 4294967295	U32	rw	RxPDO
6084h	00h	Profile deceleration	Command/s ²	0 - 4294967295	U32	rw	RxPDO
60B1h	00h	Velocity offset	Command/s	-2147483648 - 2147483647	I32	rw	RxPDO
60B2h	00h	Torque offset	0.1%	-32768 - 32767	I16	rw	RxPDO
60C5h	00h	Max acceleration	Command/s ²	0 - 4294967295	U32	rw	RxPDO
60C6h	00h	Max deceleration	Command/s ²	0 - 4294967295	U32	rw	RxPDO

- There is a related object of common motion as well.
For more information, refer to section 6-9.

Index	Sub-Index	Name	Units	Range	Data Type	Access	PDO
6007h	00h	Abort connection option code	—	0 - 3	I16	rw	No
605Ah	00h	Quick stop option code	—	0 - 7	I16	rw	No
605Bh	00h	Shutdown option code	—	0 - 1	I16	rw	No
605Ch	00h	Disable operation option code	—	0 - 1	I16	rw	No
605Dh	00h	Halt option code	—	1 - 3	I16	rw	No
605Eh	00h	Fault reaction option code	—	0 - 2	I16	rw	No
607Bh	-	Position range limit	-	-	-	-	-
	00h	Highest sub-index supported	-	2	U8	ro	No
	01h	Min position range limit	Command	-2147483648 – 2147483647	I32	rw	RxPDO
	02h	Max position range limit	Command	-2147483648 – 2147483647	I32	rw	RxPDO
607Ch	00h	Home offset	Command	-2147483648 – 2147483647	I32	rw	RxPDO
607Eh	00h	Polarity	-	0 – 255	U8	rw	No
6085h	00h	Quick stop deceleration	Command/s ²	0 – 4294967295	U32	rw	RxPDO
6086h	00h	Motion profile type	-	-32768 – 32767	I16	rw	RxPDO
608Fh	-	Position encoder resolution	-	-	-	-	-
	00h	Highest sub-index supported	-	2	U8	ro	No
	01h	Encoder increments	pulse	 1 – 4294967295	U32	ro	No
	02h	Motor revolutions	r (motor)	 1 – 4294967295	U32	ro	No
6091h	-	Gear ratio	-	-	-	-	-
	00h	Number of entries	-	2	U8	ro	No
	01h	Motor revolutions	r (motor)	 1 – 4294967295	U32	rw	No
	02h	Shaft revolutions	r (shaft)	 1 – 4294967295	U32	rw	No
6092h	-	Feed constant	-	-	-	-	-
	00h	Highest sub-index supported	-	2	U8	ro	No
	01h	Feed	Command	 1 – 4294967295	U32	rw	No
	02h	Shaft revolutions	r (shaft)	 1 – 4294967295	U32	rw	No
60A3h	00h	Profile jerk use	-	1 - 2	U8	rw	No
60A4h	-	Profile jerk	-	-	-	-	-
	00h	Highest sub-index supported	-	1 - 2	U8	ro	No
	01h	Profile jerk 1	Command/s ³	0 – 4294967295	U32	rw	No
	02h	Profile jerk 2	Command/s ³	0 – 4294967295	U32	rw	No
60B8h	00h	Touch probe function	-	0 - 65535	U16	rw	RxPDO
60FEh	-	Digital outputs	-	-	-	-	-
	00h	Number of entries	-	2	U8	ro	No
	01h	Physical outputs	-	0 - 4294967295	U32	rw	RxPDO
	02h	Bit mask	-	0 - 4294967295	U32	rw	RxPDO

- Controlword (6040h) <Functions in pp mode>

Index	Sub-Index	Name / Description	Units	Range	Data Type	Access	PDO	Op-mode	EEPROM																													
6040h	00h	Controlword • Set a command to a servo amplifier including the PDS state transition. Bit information details	-	0 - 65535	U16	rw	RxPDO	ALL	No																													
		<table border="1"> <thead> <tr> <th>15 - 10</th> <th>9</th> <th>8</th> <th>7</th> <th>6</th> <th>5</th> <th>4</th> <th>3</th> <th>2</th> <th>1</th> <th>0</th> </tr> </thead> <tbody> <tr> <td colspan="2">oms</td> <td rowspan="2">h</td> <td rowspan="2">fr</td> <td colspan="3">oms</td> <td rowspan="2">eo</td> <td rowspan="2">qs</td> <td rowspan="2">ev</td> <td rowspan="2">so</td> </tr> <tr> <td>r</td> <td>change on set-point</td> <td>absolute/ relative</td> <td>change set immediately</td> <td>new set-point</td> </tr> </tbody> </table>	15 - 10	9	8	7	6	5	4	3	2	1	0	oms		h	fr	oms			eo	qs	ev	so	r	change on set-point	absolute/ relative	change set immediately	new set-point									
15 - 10	9	8	7	6	5	4	3	2	1	0																												
oms		h	fr	oms			eo	qs	ev	so																												
r	change on set-point			absolute/ relative	change set immediately	new set-point																																
		r = reserved (not supported), oms = operation mode specific (control mode dependent bit) h = halt								fr = fault reset eo = enable operation qs = quick stop ev = enable voltage so = switch on																												

bit9, 6-4(operation mode specific):

Bit	Name	Value	Definition
4	new set-point	0->1	It is a trigger to activate a positioning operation and update a set value. Imports new positioning tasks (607Ah (Target position) and 6081h (Profile velocity) etc.).
5	change set immediately	0	After the positioning operation at present is completed, next positioning operation starts.
		1	Suspends the positioning operation at present and starts next positioning operation at once. The additional option of the operation change timing is set with the cio bit (bit3-2) of 60F2h (Positioning option code).
6	absolute/ relative	0	Handles 607Ah (Target position) as an absolute position
		1	Handles 607Ah (Target position) as a relative position. The additional option in relative positioning is set with the relative option (bit1-0) of 60F2h (Positioning option code).
9	change on set-point	-	Refer to the table below This is not supported by this software version.

The table below lists the difference of an operation according to the combination of bits 9, 5 and 4.

Bit 9	Bit 5	Bit 4	Definition
change on set-point	change set immediately	new set-point	
0	0	0->1	The next positioning operation starts after the positioning operation at present is completed (refer to example 1 or 3)
X	1	0->1	The next positioning operation is performed immediately (refer to example 1 or 2)
1	0	0->1	After the positioning operation is performed to the target position at present with the present profile velocity, the next positioning operation starts (refer to example 1 or 3) This is not supported by this software version.

(NOTE) Do not change the acceleration and deceleration(*) during motor operation.

If change the acceleration and deceleration, change Bit4(new set-point) from 0 to 1 after the motor stops.

- (*) 6083h (Profile acceleration)
- 6084h (Profile deceleration)
- 60C5h (Max acceleration)
- 60C6h (Max deceleration)

- Note that when the set point is executed (bit 4 (new set-point) is changed from 0 to 1 in the following conditions, that positioning task will be discarded.
 - Set-point when 6081h (Profile velocity) = 0
 - Set-point to the direction with which the position will not get out of the limited state by the software limit
 - Set-point to the direction with which the position will not get out of the limited state by the drive prohibition
- If the following status occurs, all the positioning tasks will be discarded, so care should be taken.
 - If run-inhibition is detected during deceleration due to halt = 1
 - If run-inhibition is detected with positioning task operating to opposite direction of positioning task being executed buffered
- Allow 2 ms from the time when pp operation is started until the next pp operation is started (the new set-point is changed from 0 to 1).
- If it is stopped with halt, the setting of 6040h: bit5, 9 and 60F2h in the positioning task being executed (during a halt stop) will be cleared inside (set value 0).

- Positioning option code (60F2h)

This object is an additional option to determine the operational specifications for positioning operation in the pp mode.

Index	Sub-Index	Name / Description	Units	Range	Data Type	Access	PDO	Op-mode	EEPROM																																	
60F2h	00h	Positioning option code	-	0 - 65535	U16	rw	RxPDO	pp	Yes																																	
<ul style="list-style-type: none"> Set the specification of positioning operation. 																																										
<table border="1"> <thead> <tr> <th>15</th> <th>14</th> <th>13</th> <th>12</th> <th>11</th> <th>10</th> <th>9</th> <th>8</th> <th>7</th> <th>6</th> <th>5</th> <th>4</th> <th>3</th> <th>2</th> <th>1</th> <th>0</th> </tr> </thead> <tbody> <tr> <td colspan="2">ms</td> <td colspan="9">reserved</td> <td colspan="2">rro</td> <td colspan="2">cio</td> <td colspan="2">relative option</td> </tr> </tbody> </table>										15	14	13	12	11	10	9	8	7	6	5	4	3	2	1	0	ms		reserved									rro		cio		relative option	
15	14	13	12	11	10	9	8	7	6	5	4	3	2	1	0																											
ms		reserved									rro		cio		relative option																											
ms = manufacturer-specific, rro = request-response option, cio = change immediately option																																										

- bit1-0(relative option):

The abs/rel bit(bit6) of 6040h(Controlword) is set to 1, determine the operation specification of relative positioning when performing the operation.

Normally it is used in mode 0.

bit 1	bit 0	Relative positioning mode	Definition
0	0	mode 0	The operation is relative to the target position (absolute coordinate value) in the last operation. When there is no target position in the last operation or the operation has been executed in other control modes, the operation is relative to the absolute coordinate value 0. When the operation has been executed in other control modes, the previous target position is discarded.
0	1	mode 1	The positioning is relative to the 6062h(Position demand value) (= value output by trajectory generator). *1)
1	0	mode 2	The positioning is relative to the 6064h (Position actual value). *1)
1	1	mode 3	reserved

*1) A propagation delay or other factors may prevent the position from reaching the expected position.

- bit3-2(cio (change immediately option)):

The change set immediately bit(bit5) of 6040h(Controlword) is set 1, determine the operation specification if start the next positioning operation immediately.

This software version supports this specification only when bits 3 and 2 are both 0.

Do not set it to a value other than 0.

bit 3	bit 2	Definition
0	0	Update the operate (including changes of Profile velocity and acceleration, etc.) new positioning tasks immediately.
0	1	A new positioning task (including the changes of profile velocity, acceleration, etc.) operate continuously to the positioning task running at present arrives(continue operation without stopping on the target position of the positioning task that is currently performed.). This software version does not support this specification.
1	0	reserved
1	1	reserved

The following indicate the operation pattern by a combination of change set immediately bit(Bit5) of 6040h(Controlword) and cio(change immediately option) bit(bit3-2) of 60F2h(Positioning option code).

6040h:00h(Bit5) change set immediately	0		1	
	00	01	00	01
60F2h:00h(Bit3-2) cio(change immediately option)				
When the target position was updated in the same direction and speed is accelerated.				
When the target position was updated in the same direction and speed is decelerated.				
When a target position is updated to a counter direction.				

A : Timing which changed the command
 B : Target position (last time) arrival timing
 C : Target position (after updating) arrival timing
 Thick line : It operates on condition of before changing a command.
 Thin line : It operates on condition of after changing a command.

* It does not arrive at the last target position.

- bit5-4(rro (request-response option)):

After the positioning operation is started, the master is supposed to set the new_set-point (bit 4) of 6040h (Control word) to 0; however this option allows the slave to automatically set it to 0.

Slave transmits to the master by setting to 0 setpoint_acknowledgement bit(bit12) of 6041h(Statusword) after releasing the new_setpoint.

Bit 5	Bit 4	Definition
0	0	The handshake is necessary, as shown in the examples 1 to 3.
0	1	The slave releases the New setpoint bit automatically as soon as the drive arrives at the target position. (It is set as 0.)
1	0	The slave releases the new setpoint bit automatically as soon as the slave accepts a new target position. (It is set as 0.)
1	1	Reserved

2) Objects related to pp mode (monitoring)

Index	Sub-Index	Name	Units	Range	Data Type	Access	PDO
6041h	00h	Statusword	-	0 - 65535	U16	ro	TxPDO

- Besides, there are related objects common to the position control.

For more information, refer to section 6-6-1.

Index	Sub-Index	Name	Units	Range	Data Type	Access	PDO
6062h	00h	Position demand value	Command	-2147483648 - 2147483647	I32	ro	TxPDO
6063h	00h	Position actual internal value	pulse	-2147483648 - 2147483647	I32	ro	TxPDO
6064h	00h	Position actual value	Command	-2147483648 - 2147483647	I32	ro	TxPDO
6065h	00h	Following error window	Command	0 - 4294967295	U32	rw	RxPDO
6066h	00h	Following error time out	1ms	0 - 65535	U16	rw	RxPDO
6067h	00h	Position window	Command	0 - 4294967295	U32	rw	RxPDO
6068h	00h	Position window time	1ms	0 - 65535	U16	rw	RxPDO
6069h	00h	Velocity sensor actual value	-	-2147483648 - 2147483647	I32	ro	TxPDO
606Ch	00h	Velocity actual value	Command/s	-2147483648 - 2147483647	I32	ro	TxPDO
6074h	00h	Torque demand	0.1%	-32768 - 32767	I16	ro	TxPDO
6076h	00h	Motor rated torque	mN•m	0 - 4294967295	U32	ro	TxPDO
6077h	00h	Torque actual value	0.1%	-32768 - 32767	I16	ro	TxPDO
60F4h	00h	Following error actual value	Command	-2147483648 - 2147483647	I32	ro	TxPDO
60FAh	00h	Control effort	Command/s	-2147483648 - 2147483647	I32	ro	TxPDO
60FCh	00h	Position demand internal value	pulse	-2147483648 - 2147483647	I32	ro	TxPDO

- There is a related object of common motion as well.

For information, refer to section 6-9.

Index	Sub-Index	Name	Units	Range	Data Type	Access	PDO
603Fh	00h	Error code	-	0 - 65535	U16	ro	TxPDO
60B9h	00h	Touch probe status	-	0 - 65535	U16	ro	TxPDO
60BAh	00h	Touch probe pos1 pos value	Command	-2147483648 - 2147483647	I32	ro	TxPDO
60BBh	00h	Touch probe pos1 neg value	Command	-2147483648 - 2147483647	I32	ro	TxPDO
60BCh	00h	Touch probe pos2 pos value	Command	-2147483648 - 2147483647	I32	ro	TxPDO
60BDh	00h	Touch probe pos2 neg value	Command	-2147483648 - 2147483647	I32	ro	TxPDO
60FDh	00h	Digital inputs	-	0 - 4294967295	U32	ro	TxPDO

- Statusword (6041h) <Functions in pp mode>

Index	Sub-Index	Name / Description	Units	Range	Data Type	Access	PDO	Op-mode	EEPROM							
6041h	00h	Statusword • Displays the servo amplifier state.	-	0 - 65535	U16	ro	TxPDO	ALL	No							
		Bit information details														
		15 - 14	13	12	11	10	9	8	7	6	5	4	3	2	1	0
		oms		oms												
		r	following error	set-point acknowledge	ila	target reached	rm	r	w	sod	qs	ve	f	oe	so	rtso
		r	= reserved (not supported),			w	= warning									
		oms	= operation mode specific (control mode dependent bit)			sod	= switch on disabled									
		ila	= internal limit active			qs	= quick stop									
		rm	= remote			ve	= voltage enabled									
					f	= fault										
					oe	= operation enabled										
					so	= switched on										
					rtso	= ready to switch on										

bit13,12,10(operation mode specific):

Bit	Name	Value	Definition
10	target reached	-	Refer to 3) of Section 6-6-1.
12	set-point acknowledge	0	The new set-point is 0, the motion is done (in process) for the last target position, and the buffer is empty
		1	Data for a new positioning task has been imported into the buffer and it is not empty
13	following error	-	Refer to 3) of Section 6-6-1.

3) Operations of pp mode

- Example 1 (basic set-point)

- [1] The master sets the value of 607Ah (Target position) and then changes the value of the bit 4 (New setpoint) of 6040h (Control word) from 0 to 1. In that case, also set 6081h (Profile velocity).
If the value of 6081h (Profile velocity) is 0, the motor does not work.
- [2] The slave confirms the rising edge (from 0 to 1) of the bit 4 (New setpoint) of 6040h (Control word) and starts the positioning motion toward the target position, 607Ah (Target position). Here, the slave changes the value of the bit 12 (Setpoint acknowledge) of 6041h (Status word) from 0 to 1.
- [3] The master confirms that the value of the bit 12 (Setpoint acknowledge) of 6041h (Status word) is changed from 0 to 1 and puts the bit 4 (New setpoint) of 6040h (Control word) back to 0.
- [4] The slave confirms that the bit 4 (New setpoint) of 6040h (Control word) is set to 0 and sets the bit 12 (Setpoint acknowledge) of 6041h (Status word) to 0.
- [5] When the motion arrives at the target position, the slave changes the value of the bit 10 (Target reached) of 6041h (Status word) from 0 to 1.

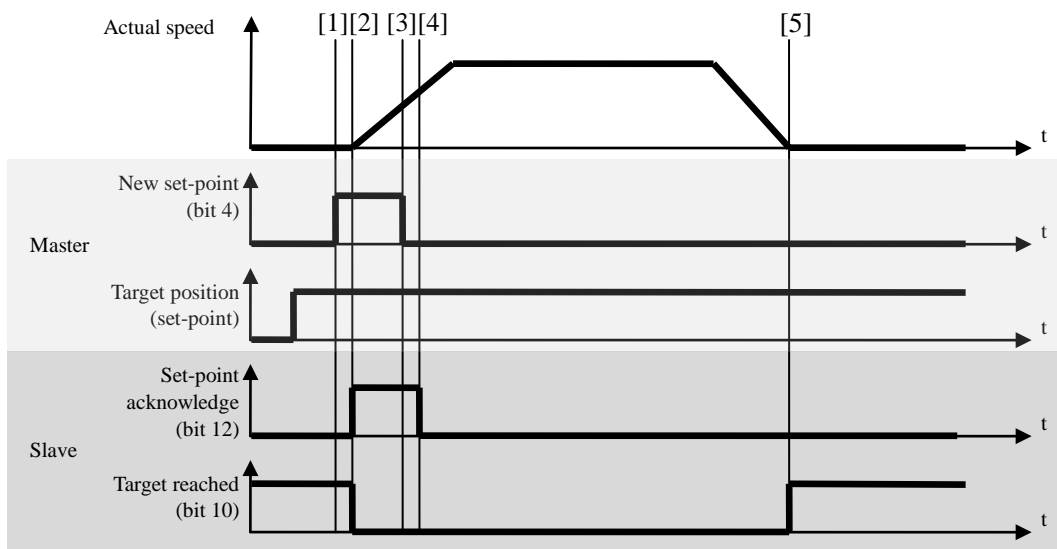

<Set-point example>

*1) 6081h (Profile velocity) is limited by the smaller of 607Fh (Max profile velocity) or 6080h (Max motor speed).

A change that is made to the preset value of 607Fh (Max profile velocity) or 6080h (Max motor speed) during operation will not be reflected in that operation.

- Example 2 (Data change in operation, without buffer: Single set-point)

When bit5(change set immediately) of 6040h(controlword) is 1, if it made changes to the data for the positioning operation during operation, interrupting the current positioning operation, is started the next positioning operation immediately.

- [1] The master confirms that the bit 12 (Set-point acknowledge) of 6041h (Status word) is 0, changes the value of 607Ah (Target position), and then changes the value of the bit 4 (New setpoint) of 6040h (Control word) from 0 to 1.
(Note) acceleration and deceleration must not change at this time.
- [2] The slave confirms the rising edge (from 0 to 1) of the bit 4 (New setpoint) of 6040h (Control word) and updates 607Ah (Target position) with a new target position. Here, the slave changes the value of the bit 12 (Setpoint acknowledge) of 6041h (Status word) from 0 to 1.
- [3] The master confirms that the value of the bit 12 (Setpoint acknowledge) of 6041h (Status word) is changed from 0 to 1 and puts the bit 4 (New setpoint) of 6040h (Control word) back to 0.
- [4] The slave confirms that the bit 4 (New setpoint) of 6040h (Control word) is set to 0 and sets the bit 12 (Setpoint acknowledge) of 6041h (Status word) to 0.

Note:

- Similar steps 1 to 4 enable to change 6081h (Profile velocity).
- Also, after changing 607Ah (Target position) and 6081h (Profile velocity), perform the steps 1 to 4 mentioned above to update 607Ah (Target position) and 6081h (Profile velocity) at the same time.

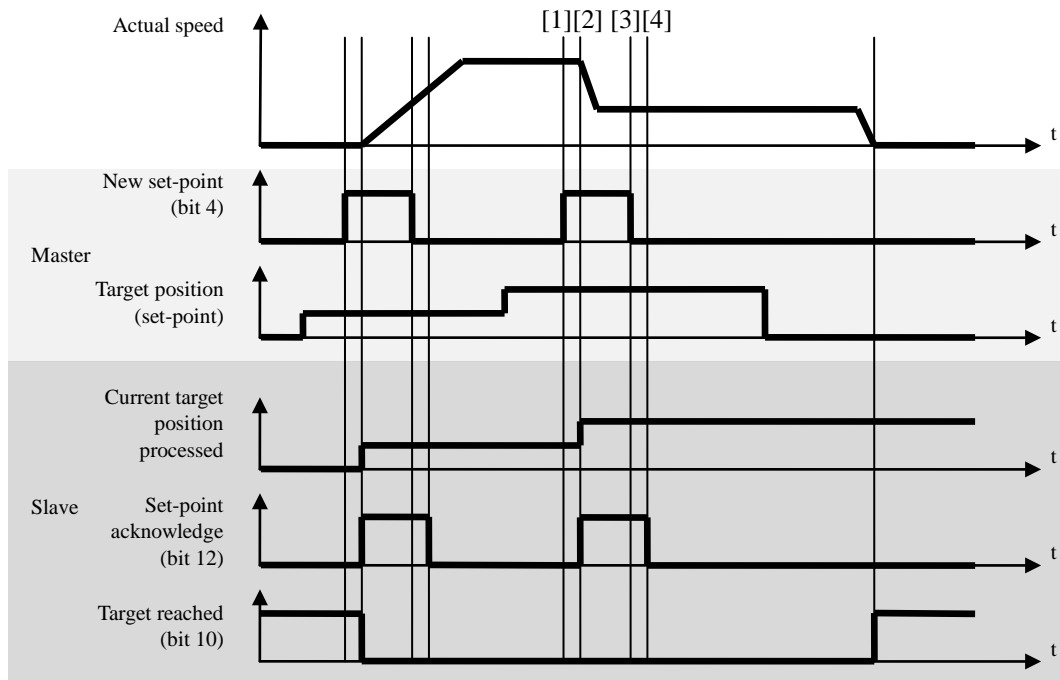

<Handshaking procedure for the single set-point method>

- Example 3 (Data change in operation, with buffer: Set of set-points)

When bit5(change set immediately) of 6040h(controlword) is 0, if it made changes to the data for the positioning operation during operation, completing the current positioning operation, is started the next positioning operation immediately.

- [1] The master confirms that the bit 12 (Set-point acknowledge) of 6041h (Status word) is 0, changes the value of 607Ah (Target position), and then changes the value of the bit 4 (New setpoint) of 6040h (Control word) from 0 to 1.
(Note) acceleration and deceleration must not change at this time.
- [2] The slave confirms the rising edge (0 to 1) of the bit 4 (New set-point) of 6040h (Control word) and buffers 607Ah (Target position) as a new target position.
Here, the slave changes the value of the bit 12 (Setpoint acknowledge) of 6041h (Status word) from 0 to 1.
At this stage, the positioning operation is continued for the target position before the change.
- [3] The master confirms that the value of the bit 12 (Set-point acknowledge) of 6041h (Status word) is changed from 0 to 1 and puts the bit 4 (New set-point) of 6040h (Control word) back to 0.
- [4] The slave confirms that bit 4 (New set-point) of 6040h (Controlword) is set to 0 and that the current positioning operation is completed, and starts a positioning operation for the new target position. At this point, the buffer becomes empty, bit 12 (Set-point acknowledge) of 6041h (Statusword) is set to 0.

Note:

- Similar steps 1 to 4 enable to change 6081h (Profile velocity).
 - After changing 607Ah (Target position) and 6081h (Profile velocity), perform the steps 1 to 4 mentioned above to update 607Ah (Target position) and 6081h (Profile velocity) at the same time.
 - The dashed line as shown in the figure below indicates actual velocity when the bit9(Change of setpoint) of 6040h (Control word) is set to 1.
- However, if the new target position is the opposite of the operating direction, the position stops at the previous target position, and a reverse operation is performed.

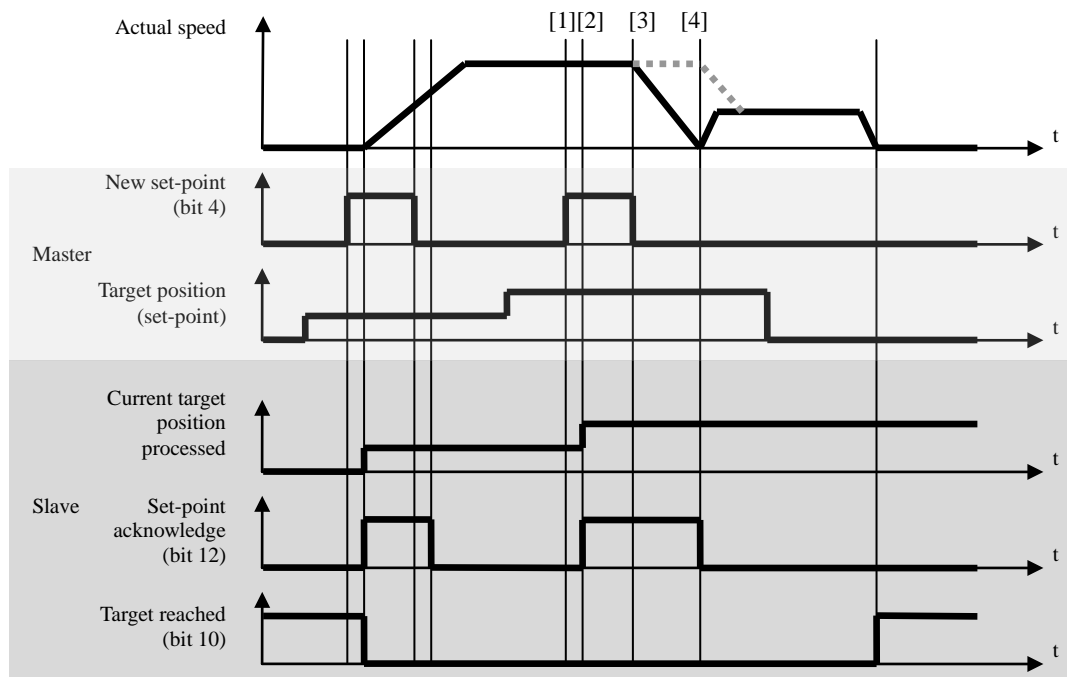

<Handshaking procedure for the set of set-point method>

- Example 4 (Buffering of set-points)

There are two set-point for the buffering set-point and the execution set-point.
The following figure indicates the handling of these set-point.

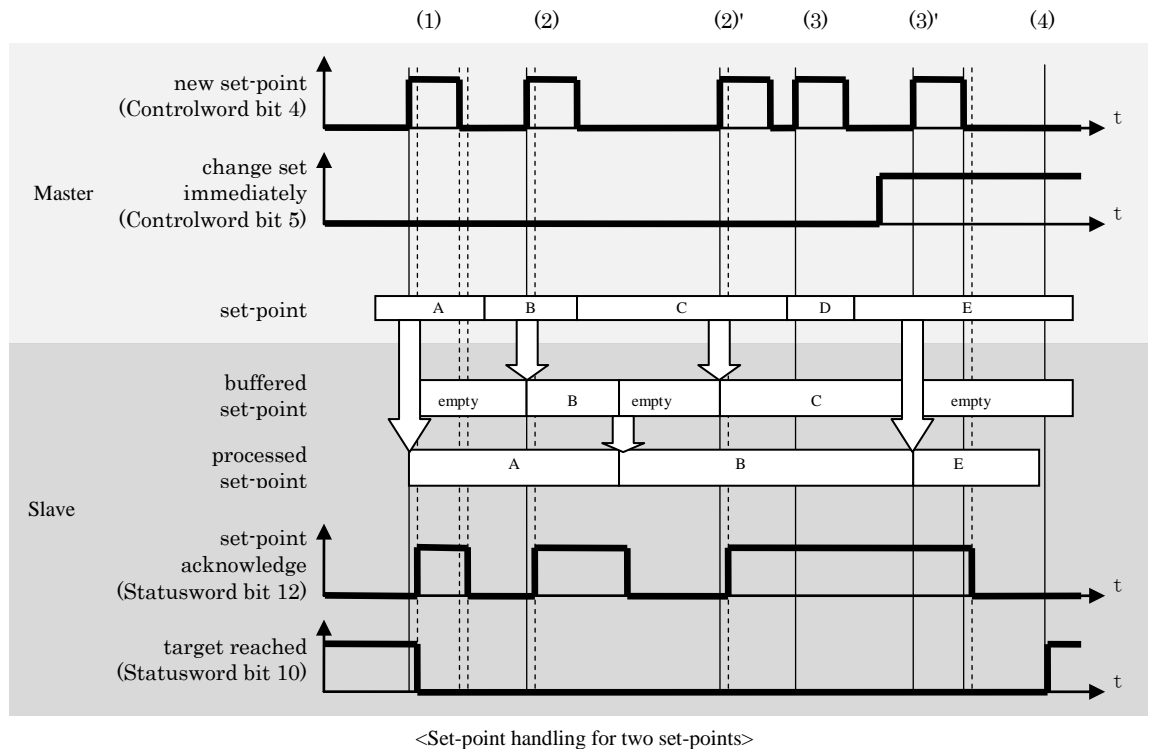

- (1) When the set-point is not in progress, a new set-point(A) will be effective immediately.
- (2) When the set-point is in progress, a new setpoint(B or C) is stored each time the first set-point buffer becomes empty.
- (3) When all set-point buffers are in use (if the bit12(Setpoint acknowledge) of 6041h(Statusword) is 1), the update of the set-point buffer is dependent on the bit5(Change set immediately) of 6040h(Controlword).
If the bit5(Change set immediately) of 6040h(Controlword) is not set to 1, new set-points(D) are not processed but suspended.
If the bit5(Change set immediately) of 6040h(Controlword) is set to 1, new set-points(E) are processed immediately as a single set-point.
In this case, all set-points(B,C and D) loaded before the bit5(Change set immediately) of 6040h(Controlword) is set to 1 are discarded.
- (4) Until all set-points are processed, the bit10(Target reached) of 6041h(Statusword) remains to be 0.

- Example 5 (Temporary stop by halt)

When bit 8 (halt) of 6040h (Controlword) changes to 1 during pp operation, the positioning operation is stopped temporarily. When bit 8 (halt) returns to 0, a positioning operation to the set-point for execution is resumed. The following figure indicates the handling of these set-points.

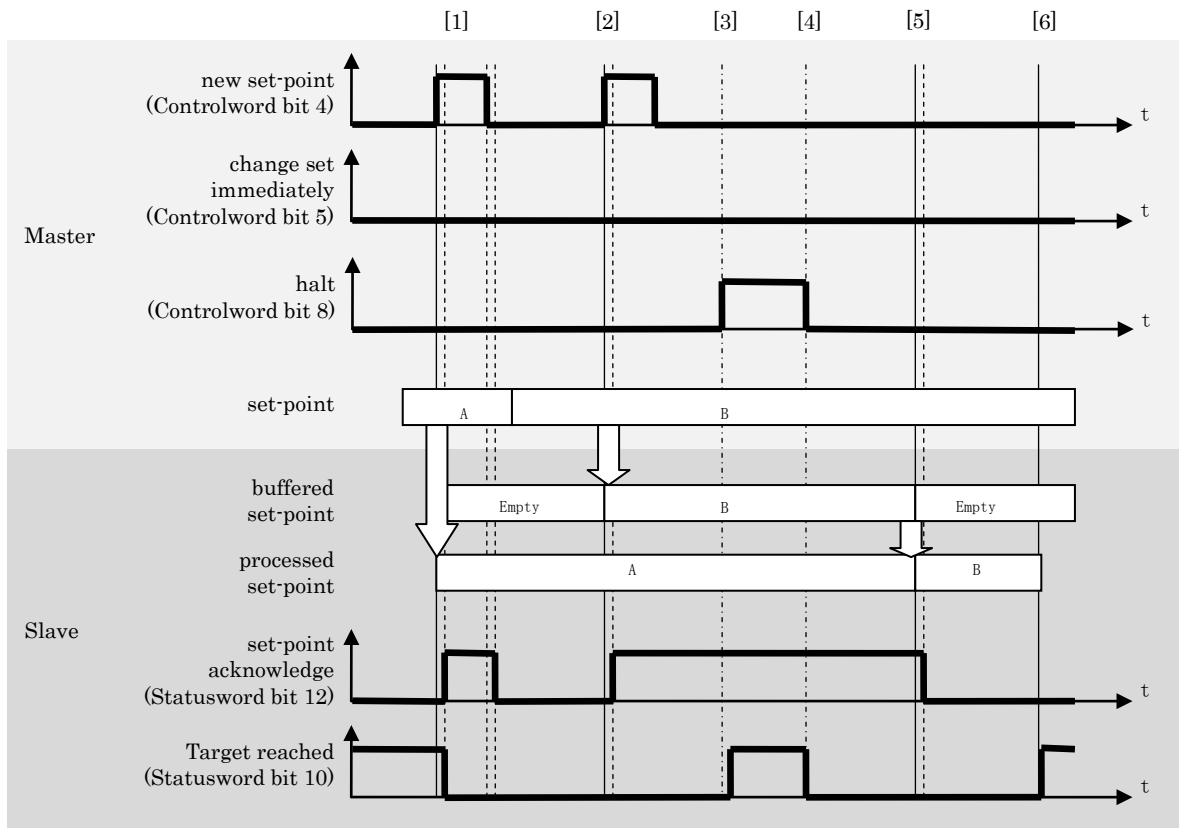

- [1] When the set-point is not in process, the new set-point(A) takes effect immediately.
- [2] When the set-point is in process, the new set-point(B) is stored if the set-point buffer is empty.
- [3] If 1 is set to bit 8 (halt) of 6040h (Controlword) while the first set-point(A) is in process, the first set-point(A) is suspended.
At this time, if deceleration stop is executed and speed reaches 0, bit10 (target reached) for 6041h (Statusword) becomes 1.
- [4] After that, when 0 is set to bit 8 (halt) of 6040h (Controlword), the operation for the first set-point is resumed.
At this time, bit10 (target reached) for 6041h (Statusword) becomes 0.
- [5] When the operation for the first set-point(A) is completed, the new set-point(B) is processed.
- [6] Bit 10 (target reached) of 6041h (Statusword) remains 0 until all set-points are processed.

6-6-3 Cyclic Position Mode (csp mode)

It is a position control mode to operate by creating a command position in the upper system (master) and updating (transmitting) the command position in an interpolation cycle.
Use it in the DC or SM2 synchronization mode.

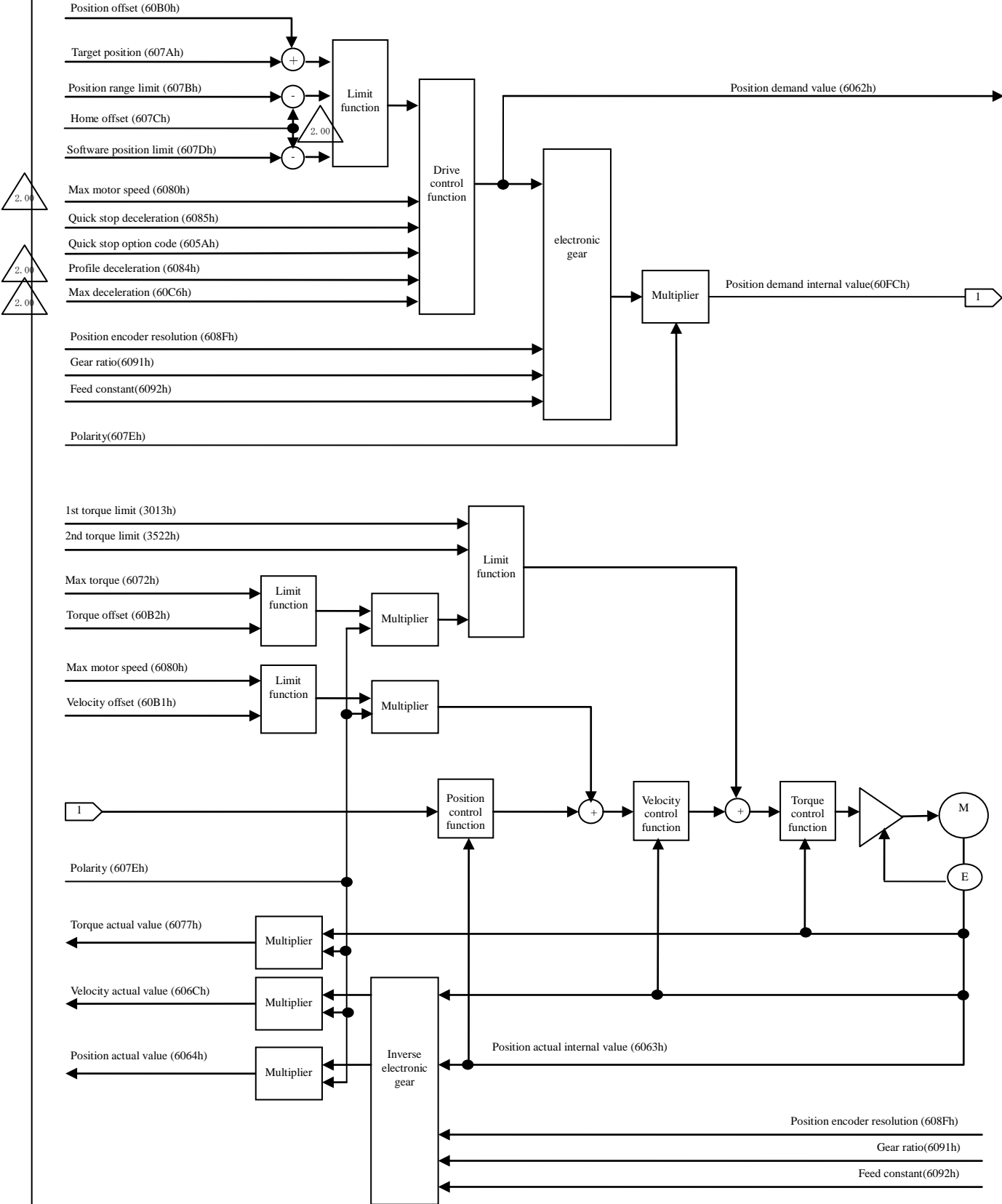

1) Objects related to csp mode (command & setup)

Index	Sub-Index	Name	Units	Range	Data Type	Access	PDO
6040h	00h	Controlword	-	0 - 65535	U16	rw	RxPDO
60B0h	00h	Position offset	Command	-2147483648 – 2147483647	I32	rw	RxPDO
3722h	00h	Communication function extended setup 1	-	-32768 - 32767	I16	rw	No
3724h	00h	Communication function extended setup 3	-	-32768 - 32767	I16	rw	No







- Besides, there are related objects common to the position control.

For more information, refer to section 6-6-1.

Index	Sub-Index	Name	Units	Range	Data Type	Access	PDO
6072h	00h	Max torque	0.1%	0 - 65535	U16	rw	RxPDO
607Ah	00h	Target position	Command	-2147483648 – 2147483647	I32	rw	RxPDO
607Dh	-	Software position limit	-	-	-	-	-
	00h	Number of entries	-	2	U8	ro	No
	01h	Min position limit	Command	-2147483648 – 2147483647	I32	rw	RxPDO
	02h	Max position limit	Command	-2147483648 – 2147483647	I32	rw	RxPDO
6080h	00h	Max motor speed	r/min	0 - 4294967295	U32	rw	RxPDO
60B1h	00h	Velocity offset	Command/s	-2147483648 - 2147483647	I32	rw	RxPDO
60B2h	00h	Torque offset	0.1%	-32768 - 32767	I16	rw	RxPDO

- There is a related object of common motion as well.

For information, refer to section 6-9.

Index	Sub-Index	Name	Units	Range	Data Type	Access	PDO
6007h	00h	Abort connection option code	—	0 - 3	I16	rw	No
605Ah	00h	Quick stop option code	—	0 - 7	I16	rw	No
605Bh	00h	Shutdown option code	—	0 - 1	I16	rw	No
605Ch	00h	Disable operation option code	—	0 - 1	I16	rw	No
605Dh	00h	Halt option code	—	1 - 3	I16	rw	No
605Eh	00h	Fault reaction option code	—	0 - 2	I16	rw	No
607Bh	-	Position range limit	-	-	-	-	-
	00h	Highest sub-index supported	-	2	U8	ro	No
	01h	Min position range limit	Command	-2147483648 – 2147483647	I32	rw	RxPDO
	02h	Max position range limit	Command	-2147483648 – 2147483647	I32	rw	RxPDO
607Ch	00h	Home offset	Command	-2147483648 – 2147483647	I32	rw	RxPDO
607Eh	00h	Polarity	-	0 – 255	U8	rw	No
6085h	00h	Quick stop deceleration	Command/s ²	0 – 4294967295	U32	rw	RxPDO
608Fh	-	Position encoder resolution	-	-	-	-	-
	00h	Highest sub-index supported	-	2	U8	ro	No
	01h	Encoder increments	pulse	 1 – 4294967295	U32	ro	No
	02h	Motor revolutions	r (motor)	 1 – 4294967295	U32	ro	No
6091h	-	Gear ratio	-	-	-	-	-
	00h	Number of entries	-	2	U8	ro	No
	01h	Motor revolutions	r (motor)	 1 – 4294967295	U32	rw	No
	02h	Shaft revolutions	r (shaft)	 1 – 4294967295	U32	rw	No
6092h	-	Feed constant	-	-	-	-	-
	00h	Highest sub-index supported	-	2	U8	ro	No
	01h	Feed	Command	 1 – 4294967295	U32	rw	No
	02h	Shaft revolutions	r (shaft)	 1 – 4294967295	U32	rw	No
60B8h	00h	Touch probe function	-	0 - 65535	U16	rw	RxPDO
60C2h	-	Interpolation time period	-	-	-	-	-
	00h	Highest sub-index supported	-	2	U8	ro	No
	01h	Interpolation time period value	-	0 - 255	U8	rw	No
	02h	Interpolation time index	-	-128 – 63	I8	rw	No
60FEh	-	Digital outputs	-	-	-	-	-
	00h	Number of entries	-	2	U8	ro	No
	01h	Physical outputs	-	0 - 4294967295	U32	rw	RxPDO
	02h	Bit mask	-	0 - 4294967295	U32	rw	RxPDO

- Controlword (6040h) <Functions in csp mode>

Index	Sub-Index	Name / Description	Units	Range	Data Type	Access	PDO	Op-mode	EEPROM																																	
6040h	00h	Controlword	-	0 - 65535	U16	rw	RxPDO	ALL	No																																	
<ul style="list-style-type: none"> Set a command to a servo amplifier including the PDS state transition. 																																										
Bit information details																																										
<table border="1"> <thead> <tr> <th>15 - 10</th> <th>9</th> <th>8</th> <th>7</th> <th>6</th> <th>5</th> <th>4</th> <th>3</th> <th>2</th> <th>1</th> <th>0</th> </tr> </thead> <tbody> <tr> <td>r</td> <td>oms</td> <td>h</td> <td>fr</td> <td colspan="3">oms</td> <td>eo</td> <td>qs</td> <td>ev</td> <td>so</td> </tr> <tr> <td></td> <td>r</td> <td></td> <td></td> <td>r</td> <td>r</td> <td>r</td> <td></td> <td></td> <td></td> <td></td> </tr> </tbody> </table>										15 - 10	9	8	7	6	5	4	3	2	1	0	r	oms	h	fr	oms			eo	qs	ev	so		r			r	r	r				
15 - 10	9	8	7	6	5	4	3	2	1	0																																
r	oms	h	fr	oms			eo	qs	ev	so																																
	r			r	r	r																																				
<ul style="list-style-type: none"> r = reserved (not supported), oms = operation mode specific (control mode dependent bit), h = halt fr = fault reset eo = enable operation qs = quick stop ev = enable voltage so = switch on 																																										

* Note: The csp mode does not use the oms bit.

- Position system

Index	Sub-Index	Name / Description	Units	Range	Data Type	Access	PDO	Op-mode	EEPROM
60B0h	00h	Position offset	Command	-2147483648 - 2147483647	I32	rw	RxPDO	csp	Yes
<ul style="list-style-type: none"> Set the offset of the position command. 									



- Other

Index	Sub-Index	Name / Description	Units	Range	Data Type	Access	PDO	Op-mode	EEPROM
3724h	00h	Communication function extended setup 3	—	-32768 - 32767	I16	rw	No	ALL	Yes
3724h bit11: The setting condition that 6041h bit12 (drive follows command value) will be 0 is changed. 0 : Limiting torque and speed limit (only cst) is included. 1 : Limiting torque and speed limit (only cst) is not included.									

2) Objects related to csp mode (monitoring)

Index	Sub-Index	Name	Units	Range	Data Type	Access	PDO
6041h	00h	Statusword	-	0 - 65535	U16	ro	TxPDO

- Besides, there are related objects common to the position control.
For more information, refer to section 6-6-1.

Index	Sub-Index	Name	Units	Range	Data Type	Access	PDO
6062h	00h	Position demand value	Command	-2147483648 - 2147483647	I32	ro	TxPDO
6063h	00h	Position actual internal value	pulse	-2147483648 - 2147483647	I32	ro	TxPDO
6064h	00h	Position actual value	Command	-2147483648 - 2147483647	I32	ro	TxPDO
6065h	00h	Following error window	Command	0 - 4294967295	U32	rw	TxPDO
6066h	00h	Following error time out	1ms	0 - 65535	U16	rw	TxPDO
6069h	00h	Velocity sensor actual value	-	-2147483648 - 2147483647	I32	ro	RxPDO
606Ch	00h	Velocity actual value	Command/s	-2147483648 - 2147483647	I32	ro	TxPDO
6074h	00h	Torque demand	0.1%	-32768 - 32767	I16	ro	TxPDO
6076h	00h	Motor rated torque	mNm	0 - 4294967295	U32	ro	TxPDO
6077h	00h	Torque actual value	0.1%	-32768 - 32767	I16	ro	TxPDO
60F4h	00h	Following error actual value	Command	-2147483648 - 2147483647	I32	ro	TxPDO
60FAh	00h	Control effort	Command/s	-2147483648 - 2147483647	I32	ro	TxPDO
60FCh	00h	Position demand internal value	pulse	-2147483648 - 2147483647	I32	ro	TxPDO

- There is a related object of common motion as well.

For information, refer to section 6-9.

Index	Sub-Index	Name	Units	Range	Data Type	Access	PDO
603Fh	00h	Error code	-	0 - 65535	U16	ro	TxPDO
60B9h	00h	Touch probe status	-	0 - 65535	U16	ro	TxPDO
60BAh	00h	Touch probe pos1 pos value	Command	-2147483648 - 2147483647	I32	ro	TxPDO
60BBh	00h	Touch probe pos1 neg value	Command	-2147483648 - 2147483647	I32	ro	TxPDO
60BCh	00h	Touch probe pos2 pos value	Command	-2147483648 - 2147483647	I32	ro	TxPDO
60BDh	00h	Touch probe pos2 neg value	Command	-2147483648 - 2147483647	I32	ro	TxPDO
60FDh	00h	Digital inputs	-	0 - 4294967295	U32	ro	TxPDO





- Statusword (6041h) <Functions in csp mode>

Index	Sub-Index	Name / Description	Units	Range	Data Type	Access	PDO	Op-mode	EEPROM																																				
6041h	00h	Statusword • Displays the servo amplifier state. Bit information details	-	0-65535	U16	ro	TxPDO	ALL	No																																				
		<table border="1"> <thead> <tr> <th>15 - 14</th> <th>13</th> <th>12</th> <th>11</th> <th>10</th> <th>9</th> <th>8</th> <th>7</th> <th>6</th> <th>5</th> <th>4</th> <th>3</th> <th>2</th> <th>1</th> <th>0</th> </tr> </thead> <tbody> <tr> <td colspan="3">oms</td> <td rowspan="2">ila</td> <td>oms</td> <td rowspan="2">rm</td> <td rowspan="2">r</td> <td rowspan="2">w</td> <td rowspan="2">sod</td> <td rowspan="2">qs</td> <td rowspan="2">ve</td> <td rowspan="2">f</td> <td rowspan="2">oe</td> <td rowspan="2">so</td> <td rowspan="2">rtso</td> </tr> <tr> <td>r</td> <td>following error</td> <td>drive follows command value</td> <td>r</td> </tr> </tbody> </table>	15 - 14	13	12	11	10	9	8	7	6	5	4	3	2	1	0	oms			ila	oms	rm	r	w	sod	qs	ve	f	oe	so	rtso	r	following error	drive follows command value	r									
15 - 14	13	12	11	10	9	8	7	6	5	4	3	2	1	0																															
oms			ila	oms	rm	r	w	sod	qs	ve	f	oe	so	rtso																															
r	following error	drive follows command value		r																																									
		r = reserved (not supported), oms = operation mode specific (control mode dependent bit) ila = internal limit active rm = remote w = warning sod = switch on disabled qs = quick stop ve = voltage enabled f = fault oe = operation enabled so = switched on rtso = ready to switch on																																											

bit13,12,10(operation mode specific):

Bit	Name	Value	Definition
10	reserved	-	Not used
12	Drive follows command value	0	Operation is not performed according to the target position. *1)
		1	Operation is performed according to the target position. *1)
13	following error	-	Please refer to 3) of Section 6-6-1.

*1) "Operation is performed according to the target position" refers to cases where the following conditions are all satisfied

- PDS state is Operation enabled 
- POT not detected when a positive direction operation command is in process or NOT not detected when a negative direction operation command is in process
- While not in Halt status 
- POT not detected when a positive direction operation command is in process or NOT is not detected when a negative direction operation command is in process. 
- Torque limit has not occurred(Valid only when this condition 3724h-bit11 is 0) 
- When a positive direction operation command is in process, the actual position or the commanded position is within the range set by 607Dh-02h.
- When a negative direction operation command is in process, the actual position or the commanded position is within the range set by 607Dh-01h.

 2.00

Index	Sub-Index	Name / Description	Units	Range	Data Type	Access	PDO	Op-mode	EEPROM
3724h	00h	Communication function extended setup 3 3724h bit11: The setting condition that 6041h bit12 (drive follows command value) will be 0 is changed. 0 : Limiting torque and speed limit (only cst) is included. 1 : Limiting torque and speed limit (only cst) is not included.	—	-32768 - 32767	I16	rw	No	ALL	Yes

3) Operations of csp mode

- Motion profile (trajectory) generation is done in the master rather than the slave in cyclic position control mode.
- Target position is the sum of 60B0h (Position offset) and 607Ah (Target position), and is interpreted as an absolute position.
- For the operation command update (transmission), do input when approx. 100 ms has elapsed after the servo ON(Operation enabled).
- 60C2h (Interpolation time period) indicates the cycle update two objects 607Ah (Target Position) and 60B0h (Position offset). This value is set to the same period 1C32h-02h (Cycle time).
As for the upper system (master), be sure to update the target position in the cycle of 60C2h (Interpolation time period).
- In the servo-off state, configure the master process so as to follow 6064h (Position actual value) the additional value of 60B0h (Position offset) and 607Ah (Target Position).
When it did not follow, because if the motor is moving, such as external force during servo-off, the operation is trying to return to the target position that was inputted at the time of servo-on next time, it is very dangerous. Configure the similar following process when switching to csp control mode from other control modes than csp control mode as well.

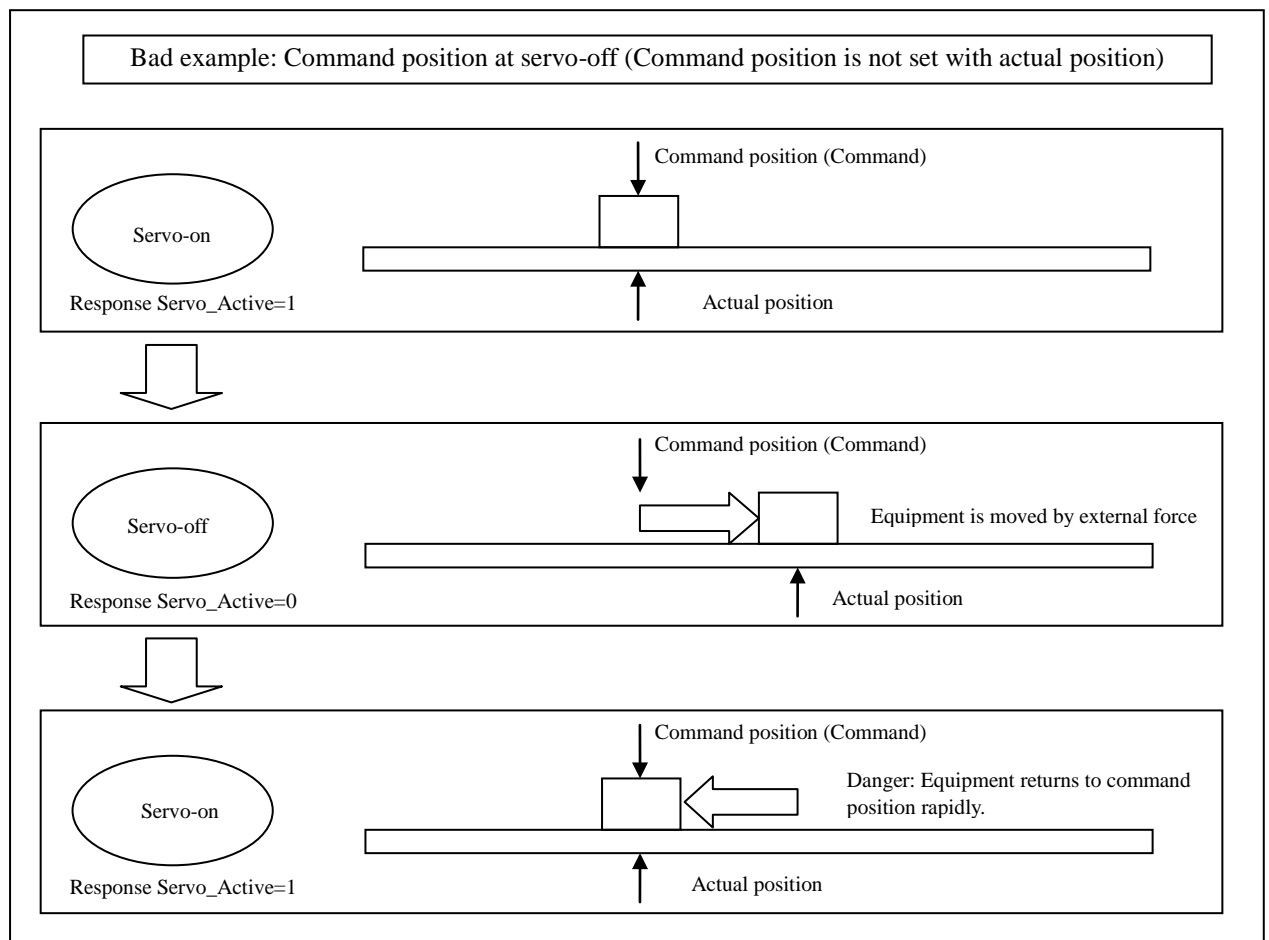

4) Calibration process on the occurrence of communication error

If a communication error occurred during operation and 607Ah (Target Position) could not be restored properly, the target position is presumed and calibration is performed.

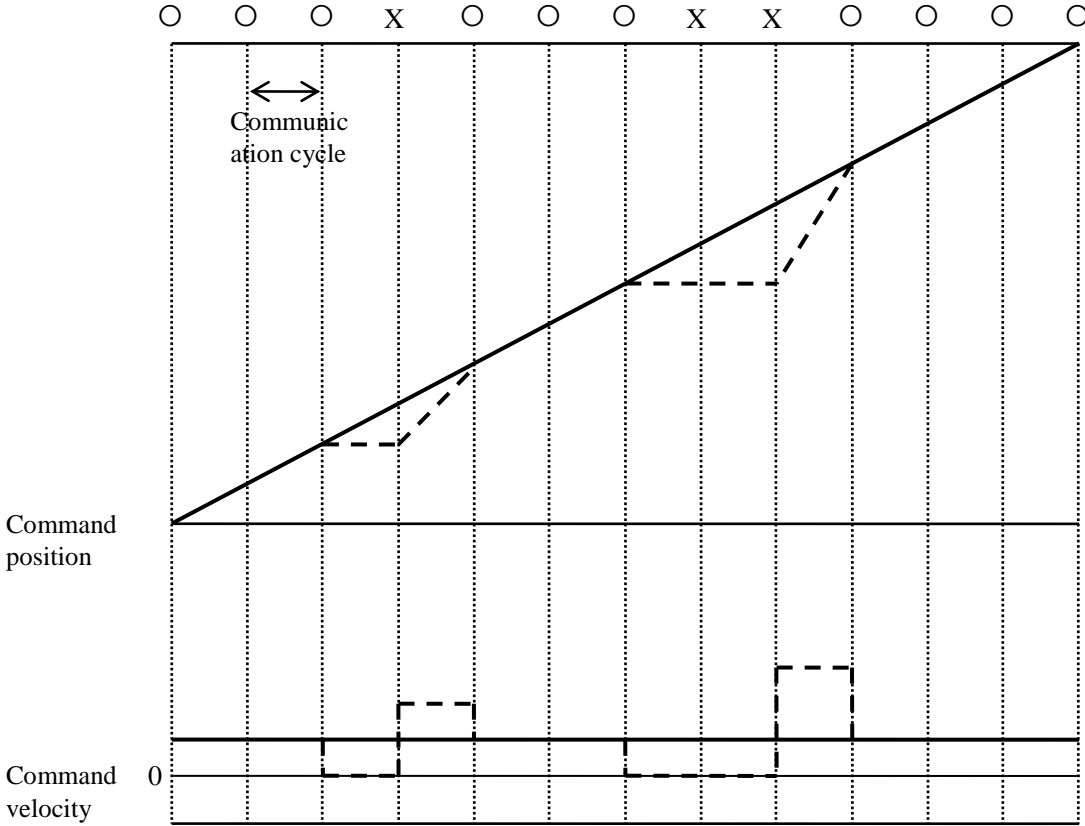

Solid line: After command calibration, dashed line: Before command calibration
O: Communication successful, X: Communication error



5) Amount of change saturation function of command position

This is to prevent the occurrence of Err27.4 by an unusual command position value and the ability to saturate the amount of change in the command position converted from 6080h (Max motor speed) for the purpose of stabilizing the behavior of motor.

• Scope

This function following control mode only supports.

Conditions that command position saturation function to operate	
Control mode	Position control(csp)

• Related objects

Index	Sub-Index	Name / Description	Units	Range	Data Type	Access	PDO	Op-mode	EEPROM
3722h	00h	Communication function extended setup 1 bit5:6080h(Max motor speed) on csp mode(Amount of change saturation function of command position) 0: Invalid on csp 1: Valid on csp	—	-32768 - 32767	I16	rw	No	ALL	Yes
6080h	00h	Max motor speed • Set the maximum velocity of motor. • Since this servo amplifier automatically sets the value based on the motor information, the setup is not necessary. • The maximum value is limited by the maximum speed read out from the motor in internal processing. • It is tq and cst and restricts speed with the preset value of this object.	r/min	0 – 4294967295	U32	rw	RxPDO	ALL	Yes



Note)

- When this function is valid(3722h bit5=1), it suppress Err27.4 by dividing a command position even if the command position is unusual.
- When this function is valid(3722h bit5=1) and 6080h=0, the amount of change in the command position is limited to 0 and the motor does not move.
And bit11(internal limit active) of 6041h(Statusword) does not become 1.

• Example(Interpolation cycle=250us)

If the change amount of the target position exceeds the command limit value from the host device saturated with limit values obtained by converting the command position change per interpolation cycle from 6080h.

This prevents the occurrence of Err27.4 even if the host device sends an unusual command position, the operation is stabilized.

<During invalid amount of change saturation function of command position>

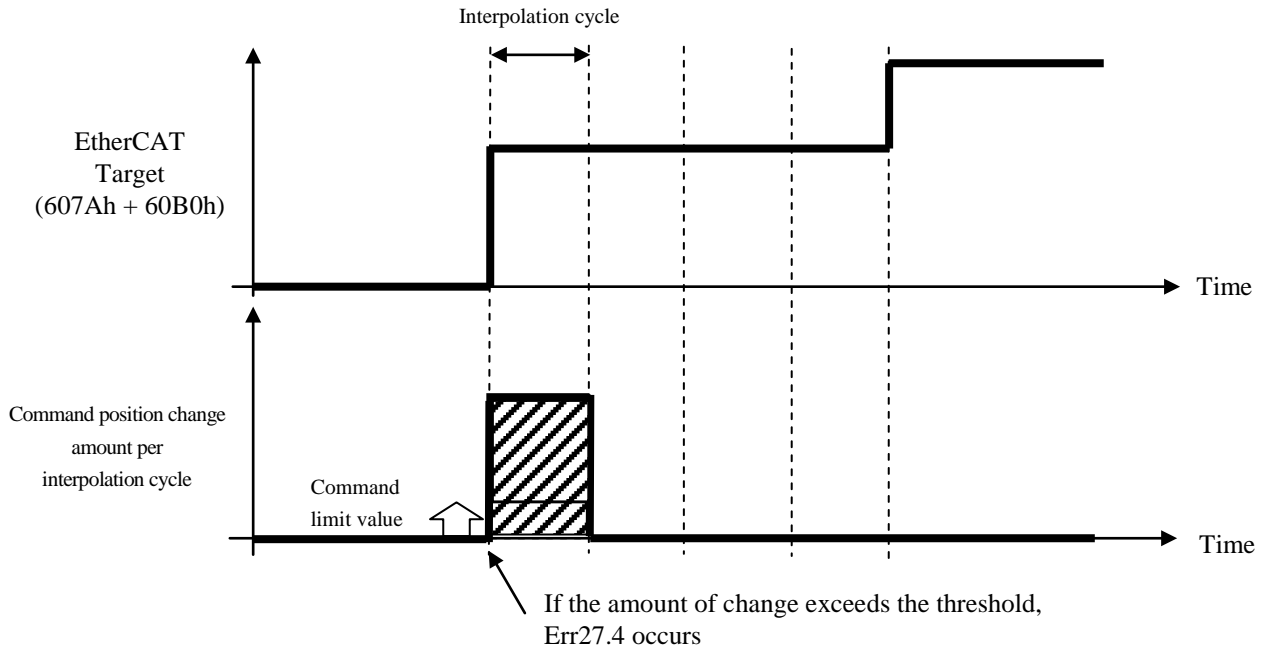

<During valid amount of change saturation function of command position>

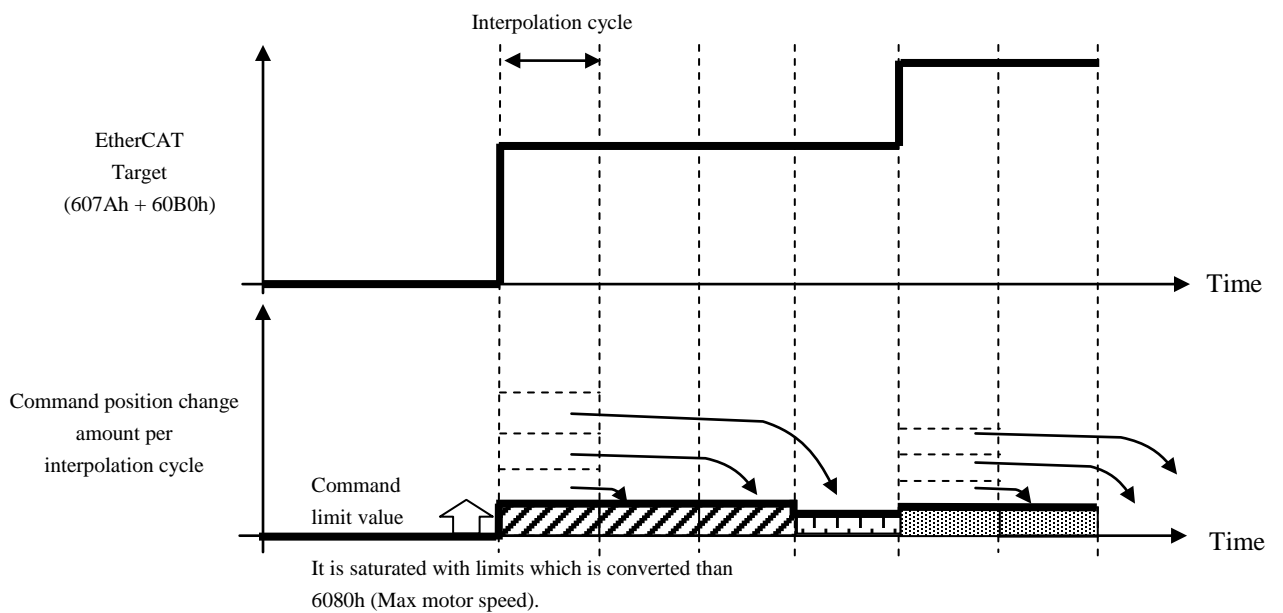

6-6-4 Interpolating Position Mode (ip mode) (Not supported)

This mode is not supported by this software version.
Do not set 6060h (Modes of operation) to 7.

It is a position control mode to operate by creating a command position in the upper system (master) and updating the command position buffered by buffering it to the servo amplifier inside in the communication cycle in an interpolation time.

6-6-5 Homing Position Mode (hm mode)

It is a position control mode to execute an origin return operation by designating the origin return method, operation speed, etc. and creating a position command in the servo amplifier. If it is used in the incremental mode, it is necessary to execute the origin return operation before executing the positioning operation after the power is turned on.

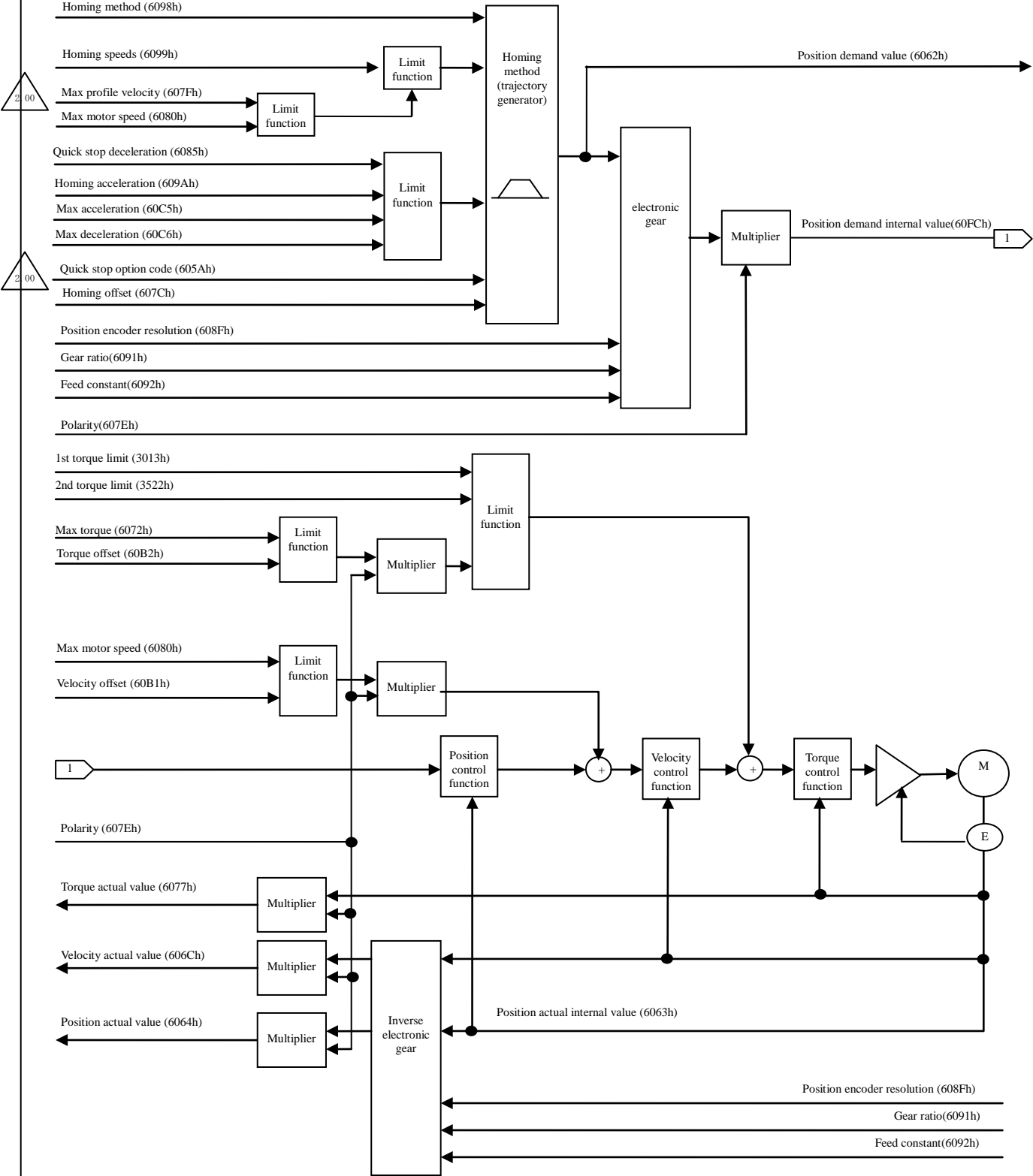

1) Objects related to hm mode (command & setup)

Index	Sub-Index	Name	Units	Range	Data Type	Access	PDO
6040h	00h	Controlword	-	0 - 65535	U16	rw	RxPDO
6098h	00h	Homing method	-	-128 - 127	I8	rw	RxPDO
6099h	-	Homing speeds	-	-	-	-	-
	00h	Number of entries	-	2	U8	ro	No
	01h	Speed during search for switch	Command/s	0 - 4294967295	U32	rw	RxPDO
	02h	Speed during search for zero	Command/s	0 - 4294967295	U32	rw	RxPDO
609Ah	00h	Homing acceleration	Command/s ²	0 - 4294967295	U32	rw	RxPDO







- Besides, there are related objects common to the position control.

For more information, refer to section 6-6-1.

Index	Sub-Index	Name	Units	Range	Data Type	Access	PDO
6072h	00h	Max torque	0.1%	0 - 65535	U16	rw	RxPDO
607Fh	00h	Max profile velocity	Command/s	0 - 4294967295	U32	rw	RxPDO
6080h	00h	Max motor speed	r/min	0 - 4294967295	U32	rw	RxPDO
60B1h	00h	Velocity offset	Command/s	-2147483648 - 2147483647	I32	rw	RxPDO
60B2h	00h	Torque offset	0.1%	-32768 - 32767	I16	rw	RxPDO
60C5h	00h	Max acceleration	Command/s ²	0 - 4294967295	U32	rw	RxPDO
60C6h	00h	Max deceleration	Command/s ²	0 - 4294967295	U32	rw	RxPDO

- There is a related object of common motion as well.

For information, refer to section 6-9.

Index	Sub-Index	Name	Units	Range	Data Type	Access	PDO
6007h	00h	Abort connection option code	-	0 - 3	I16	rw	No
605Ah	00h	Quick stop option code	-	0 - 7	I16	rw	No
605Bh	00h	Shutdown option code	-	0 - 1	I16	rw	No
605Ch	00h	Disable operation option code	-	0 - 1	I16	rw	No
605Dh	00h	Halt option code	-	1 - 3	I16	rw	No
605Eh	00h	Fault reaction option code	-	0 - 2	I16	rw	No
607Bh	-	Position range limit	-	-	-	-	-
	00h	Highest sub-index supported	-	2	U8	ro	No
	01h	Min position range limit	Command	-2147483648 – 2147483647	I32	rw	RxPDO
	02h	Max position range limit	Command	-2147483648 – 2147483647	I32	rw	RxPDO
607Ch	00h	Home offset	Command	-2147483648 – 2147483647	I32	rw	RxPDO
607Eh	00h	Polarity	-	0 – 255	U8	rw	No
6085h	00h	Quick stop deceleration	Command/s ²	0 – 4294967295	U32	rw	RxPDO
608Fh	-	Position encoder resolution	-	-	-	-	-
	00h	Highest sub-index supported	-	2	U8	ro	No
	01h	Encoder increments	pulse	 1 – 4294967295	U32	ro	No
	02h	Motor revolutions	r (motor)	 1 – 4294967295	U32	ro	No
6091h	-	Gear ratio	-	-	-	-	-
	00h	Number of entries	-	2	U8	ro	No
	01h	Motor revolutions	r (motor)	 1 – 4294967295	U32	rw	No
	02h	Shaft revolutions	r (shaft)	 1 – 4294967295	U32	rw	No
6092h	-	Feed constant	-	-	-	-	-
	00h	Highest sub-index supported	-	2	U8	ro	No
	01h	Feed	Command	 1 – 4294967295	U32	rw	No
	02h	Shaft revolutions	r (shaft)	 1 – 4294967295	U32	rw	No
60B8h	00h	Touch probe function	-	0 - 65535	U16	rw	RxPDO
60FEh	-	Digital outputs	-	-	-	-	-
	00h	Number of entries	-	2	U8	ro	No
	01h	Physical outputs	-	0 - 4294967295	U32	rw	RxPDO
	02h	Bit mask	-	0 - 4294967295	U32	rw	RxPDO

- Controlword (6040h) <Functions in hm mode>

Index	Sub-Index	Name / Description	Units	Range	Data Type	Access	PDO	Op-mode	EEPROM																						
6040h	00h	Controlword	-	0 - 65535	U16	rw	RxPDO	ALL	No																						
<ul style="list-style-type: none"> Set a command to a servo amplifier including the PDS state transition. 																															
Bit information details																															
<table border="1"> <thead> <tr> <th>15 - 10</th> <th>9</th> <th>8</th> <th>7</th> <th>6</th> <th>5</th> <th>4</th> <th>3</th> <th>2</th> <th>1</th> <th>0</th> </tr> </thead> <tbody> <tr> <td>r</td> <td>oms r</td> <td>h</td> <td>fr</td> <td colspan="3">oms</td> <td>eo</td> <td>qs</td> <td>ev</td> <td>so</td> </tr> </tbody> </table>										15 - 10	9	8	7	6	5	4	3	2	1	0	r	oms r	h	fr	oms			eo	qs	ev	so
15 - 10	9	8	7	6	5	4	3	2	1	0																					
r	oms r	h	fr	oms			eo	qs	ev	so																					
<table> <tbody> <tr> <td>r</td> <td>= reserved (not supported)</td> <td>fr</td> <td>= fault reset</td> </tr> <tr> <td>oms</td> <td>= operation mode specific (control mode dependent bit)</td> <td>eo</td> <td>= enable operation</td> </tr> <tr> <td>h</td> <td>= halt</td> <td>qs</td> <td>= quick stop</td> </tr> <tr> <td></td> <td></td> <td>ev</td> <td>= enable voltage</td> </tr> <tr> <td></td> <td></td> <td>so</td> <td>= switch on</td> </tr> </tbody> </table>										r	= reserved (not supported)	fr	= fault reset	oms	= operation mode specific (control mode dependent bit)	eo	= enable operation	h	= halt	qs	= quick stop			ev	= enable voltage			so	= switch on		
r	= reserved (not supported)	fr	= fault reset																												
oms	= operation mode specific (control mode dependent bit)	eo	= enable operation																												
h	= halt	qs	= quick stop																												
		ev	= enable voltage																												
		so	= switch on																												

bit9,6-4(operation mode specific):

Bit	Name	Value	Definition
4	Start homing	0 -> 1	The homing operation starts.
5	(reserved)	-	Not used
6	(reserved)	-	Not used
9	(reserved)	-	Not used

When bit 4 (start homing) of 6040h (Controlword) is started, parameters related to the homing position control mode (hm) (homing method, velocity, acceleration, deceleration, etc.) are stored, and the operation is started. Even if a new return to home position operation is started during the return to home position operation (bit4 for 6040h is started up again), the new return to home position operation will be ignored.

- Homing method (6098h)

Index	Sub-Index	Name / Description	Units	Range	Data Type	Access	PDO	Op-mode	EEPROM																																																																								
6098h	00h	Homing method	-	-128 - 127	I8	rw	No	hm	Yes																																																																								
<ul style="list-style-type: none"> Set the homing method. <table border="1" style="margin-left: 40px;"> <thead> <tr> <th>Value</th> <th>Definition</th> </tr> </thead> <tbody> <tr><td>0</td><td>No homing method assigned</td></tr> <tr><td>1</td><td>-Ve LS & Index Pulse</td></tr> <tr><td>2</td><td>+Ve LS & Index Pulse</td></tr> <tr><td>3</td><td>+Ve HS & Index Pulse direction reversal</td></tr> <tr><td>4</td><td>+Ve HS & Index Pulse no direction change</td></tr> <tr><td>5</td><td>-Ve HS & Index Pulse direction reversal</td></tr> <tr><td>6</td><td>-Ve HS & Index Pulse no direction change</td></tr> <tr><td>7</td><td>on +Ve HS -Index Pulse</td></tr> <tr><td>8</td><td>on +Ve HS +Index Pulse</td></tr> <tr><td>9</td><td>After +ve HS reverse +Index Pulse</td></tr> <tr><td>10</td><td>After +ve HS +Index Pulse</td></tr> <tr><td>11</td><td>on -Ve HS -Index Pulse</td></tr> <tr><td>12</td><td>on -Ve HS +Index Pulse</td></tr> <tr><td>13</td><td>After -ve HS reverse +Index Pulse</td></tr> <tr><td>14</td><td>After -ve HS +Index Pulse</td></tr> <tr><td>15</td><td>Reserved</td></tr> <tr><td>16</td><td>Reserved</td></tr> <tr><td>17</td><td>Same as 1 without Index Pulse</td></tr> <tr><td>18</td><td>Same as 2 without Index Pulse</td></tr> <tr><td>19</td><td>Same as 3 without Index Pulse</td></tr> <tr><td>20</td><td>Same as 4 without Index Pulse</td></tr> <tr><td>21</td><td>Same as 5 without Index Pulse</td></tr> <tr><td>22</td><td>Same as 6 without Index Pulse</td></tr> <tr><td>23</td><td>Same as 7 without Index Pulse</td></tr> <tr><td>24</td><td>Same as 8 without Index Pulse</td></tr> <tr><td>25</td><td>Same as 9 without Index Pulse</td></tr> <tr><td>26</td><td>Same as 10 without Index Pulse</td></tr> <tr><td>27</td><td>Same as 11 without Index Pulse</td></tr> <tr><td>28</td><td>Same as 12 without Index Pulse</td></tr> <tr><td>29</td><td>Same as 13 without Index Pulse</td></tr> <tr><td>30</td><td>Same as 14 without Index Pulse</td></tr> <tr><td>33</td><td>On Index Pulse +Ve direction</td></tr> <tr><td>34</td><td>On Index Pulse -Ve direction</td></tr> <tr><td>35</td><td>Current position = home</td></tr> <tr><td>37</td><td>Current position = home</td></tr> </tbody> </table> <p style="margin-left: 40px;">+Ve : positive direction LS : Limit switch - Ve : negative direction HS: Home switch</p>										Value	Definition	0	No homing method assigned	1	-Ve LS & Index Pulse	2	+Ve LS & Index Pulse	3	+Ve HS & Index Pulse direction reversal	4	+Ve HS & Index Pulse no direction change	5	-Ve HS & Index Pulse direction reversal	6	-Ve HS & Index Pulse no direction change	7	on +Ve HS -Index Pulse	8	on +Ve HS +Index Pulse	9	After +ve HS reverse +Index Pulse	10	After +ve HS +Index Pulse	11	on -Ve HS -Index Pulse	12	on -Ve HS +Index Pulse	13	After -ve HS reverse +Index Pulse	14	After -ve HS +Index Pulse	15	Reserved	16	Reserved	17	Same as 1 without Index Pulse	18	Same as 2 without Index Pulse	19	Same as 3 without Index Pulse	20	Same as 4 without Index Pulse	21	Same as 5 without Index Pulse	22	Same as 6 without Index Pulse	23	Same as 7 without Index Pulse	24	Same as 8 without Index Pulse	25	Same as 9 without Index Pulse	26	Same as 10 without Index Pulse	27	Same as 11 without Index Pulse	28	Same as 12 without Index Pulse	29	Same as 13 without Index Pulse	30	Same as 14 without Index Pulse	33	On Index Pulse +Ve direction	34	On Index Pulse -Ve direction	35	Current position = home	37	Current position = home
Value	Definition																																																																																
0	No homing method assigned																																																																																
1	-Ve LS & Index Pulse																																																																																
2	+Ve LS & Index Pulse																																																																																
3	+Ve HS & Index Pulse direction reversal																																																																																
4	+Ve HS & Index Pulse no direction change																																																																																
5	-Ve HS & Index Pulse direction reversal																																																																																
6	-Ve HS & Index Pulse no direction change																																																																																
7	on +Ve HS -Index Pulse																																																																																
8	on +Ve HS +Index Pulse																																																																																
9	After +ve HS reverse +Index Pulse																																																																																
10	After +ve HS +Index Pulse																																																																																
11	on -Ve HS -Index Pulse																																																																																
12	on -Ve HS +Index Pulse																																																																																
13	After -ve HS reverse +Index Pulse																																																																																
14	After -ve HS +Index Pulse																																																																																
15	Reserved																																																																																
16	Reserved																																																																																
17	Same as 1 without Index Pulse																																																																																
18	Same as 2 without Index Pulse																																																																																
19	Same as 3 without Index Pulse																																																																																
20	Same as 4 without Index Pulse																																																																																
21	Same as 5 without Index Pulse																																																																																
22	Same as 6 without Index Pulse																																																																																
23	Same as 7 without Index Pulse																																																																																
24	Same as 8 without Index Pulse																																																																																
25	Same as 9 without Index Pulse																																																																																
26	Same as 10 without Index Pulse																																																																																
27	Same as 11 without Index Pulse																																																																																
28	Same as 12 without Index Pulse																																																																																
29	Same as 13 without Index Pulse																																																																																
30	Same as 14 without Index Pulse																																																																																
33	On Index Pulse +Ve direction																																																																																
34	On Index Pulse -Ve direction																																																																																
35	Current position = home																																																																																
37	Current position = home																																																																																

Note:

- When the Homing operation starts with other than setting values supported by 6098h (Homing method), an Homing error occurs (bits13 of 6041h(Status word) is 1).
- The Homing method cannot be changed while the homing position control mode (hm) is in process. To change the Homing method, stop the motor (stop the hm mode).

- Homing speeds (6099h)

Index	Sub-Index	Name / Description	Units	Range	Data Type	Access	PDO	Op-mode	EEPROM
6099h		Homing speeds • Set the velocity during the Homing mode (hm).	-	-	-	-	-	-	-
	00h	Number of entries • Displays the number of sub-indexes for 6099h (Homing speeds).	-	2	U8	ro	No	hm	No
	01h	Speed during search for switch • Set the operation velocity until the Switch signal is detected. • The maximum value is limited by the internal processing at 6080h(Max motor speed).	Command/s	0 - 4294967295	U32	rw	RxPDO	hm	Yes
	02h	Speed during search for zero • Set the operation velocity until the position is detected homing. If the home detection position is the edge of the Switch signal, set this value as small as possible. • The maximum value is limited by the internal processing at 6080h(Max motor speed).	Command/s	0 - 4294967295	U32	rw	RxPDO	hm	Yes

Note: For more information about applying for each speed, refer to the example of the operation of each Homing method.

- Homing acceleration (609Ah)

Index	Sub-Index	Name / Description	Units	Range	Data Type	Access	PDO	Op-mode	EEPROM
609Ah	00h	Homing acceleration • Set the acceleration and deceleration during the Homing mode (hm). • The deceleration of homing operation are common in this object. • At the final stop of each Homing method (when the homing position is detected), the servo lock is carried out for the stopping, instead of using the preset value of this object. • If it is set to 0, internal processing is treated as 1.	Command/s ²	0 - 4294967295	U32	rw	RxPDO	hm	Yes

2) Objects related to hm mode (monitoring)

Index	Sub-Index	Name	Units	Range	Data Type	Access	PDO
6041h	00h	Statusword	-	0 - 65535	U16	ro	TxPDO
60E3h	-	Supported homing method	-	-	-	-	-
	00h	Number of entries	-	1 - 254	U8	ro	No
	01h	1st supported homing method	-	0 - 32767	U16	ro	No
	to	-	-	-	-	-	-
	FEh	254th supported homing method	-	0 - 32767	U16	ro	No

- Besides, there are related objects common to the position control.

For more information, refer to section 6-6-1.

Index	Sub-Index	Name	Units	Range	Data Type	Access	PDO
6062h	00h	Position demand value	Command	-2147483648 - 2147483647	I32	ro	TxPDO
6063h	00h	Position actual internal value	pulse	-2147483648 - 2147483647	I32	ro	TxPDO
6064h	00h	Position actual value	Command	-2147483648 - 2147483647	I32	ro	TxPDO
6069h	00h	Velocity sensor actual value	-	-2147483648 - 2147483647	I32	ro	TxPDO
606Ch	00h	Velocity actual value	Command/s	-2147483648 - 2147483647	I32	ro	TxPDO
6074h	00h	Torque demand	0.1%	-32768 - 32767	I16	ro	TxPDO
6076h	00h	Motor rated torque	mNm	0 - 4294967295	U32	ro	TxPDO
6077h	00h	Torque actual value	0.1%	-32768 - 32767	I16	ro	TxPDO
60F4h	00h	Following error actual value	Command	-2147483648 - 2147483647	I32	ro	TxPDO
60FAh	00h	Control effort	Command/s	-2147483648 - 2147483647	I32	ro	TxPDO
60FCh	00h	Position demand internal value	pulse	-2147483648 - 2147483647	I32	ro	TxPDO

- There is a related object of common motion as well.

For information, refer to section 6-9.

Index	Sub-Index	Name	Units	Range	Data Type	Access	PDO
603Fh	00h	Error code	-	0 - 65535	U16	ro	TxPDO
60B9h	00h	Touch probe status	-	0 - 65535	U16	ro	TxPDO
60BAh	00h	Touch probe pos1 pos value	Command	-2147483648 - 2147483647	I32	ro	TxPDO
60BBh	00h	Touch probe pos1 neg value	Command	-2147483648 - 2147483647	I32	ro	TxPDO
60BCh	00h	Touch probe pos2 pos value	Command	-2147483648 - 2147483647	I32	ro	TxPDO
60BDh	00h	Touch probe pos2 neg value	Command	-2147483648 - 2147483647	I32	ro	TxPDO
60FDh	00h	Digital inputs	-	0 - 4294967295	U32	ro	TxPDO

- Supported homing method (60E3h)

Index	Sub-Index	Name / Description	Units	Range	Data Type	Access	PDO	Op-mode	EEPROM
60E3h		Supported homing method • Displays the homing methods supported.	-	-	-	-	-	-	-
	00h	Number of entries • Displays the number of homing method that it supports for 60E3h (Supported homing method).	-	01h to FEh	U8	ro	No	hm	No
	01h	1 st supported homing method • Displays the first homing method supported.	-	0 - 32767	U16	ro	No	hm	No
	to	-	-	0 - 32767	U16	ro	No	hm	No
	FEh	254 th supported homing method • Displays the 254th homing method supported.	-	0 - 32767	U16	ro	No	hm	No

Index	Sub-Index	bit 15 to 8	bit 7 to 0
		Reserved	Supported Homing method *1)
60E3h	01h	0	1
	02h	0	2
	03h	0	3
	04h	0	4
	05h	0	5
	06h	0	6
	07h	0	7
	08h	0	8
	09h	0	9
	0Ah	0	10
	0Bh	0	11
	0Ch	0	12
	0Dh	0	13
	0Eh	0	14
	0Fh	0	17
	10h	0	18
	11h	0	19
	12h	0	20
	13h	0	21
	14h	0	22
15h	0	23	
16h	0	24	
17h	0	25	
18h	0	26	
19h	0	27	
1Ah	0	28	
1Bh	0	29	
1Ch	0	30	
1Dh	0	33	
1Eh	0	34	
1Fh	0	35	
20h	0	37	

*1) The relation between Homing method and values refer to 6098h(Homing method).

3) Operations of hm mode (Homing operation)

When using incremental mode, perform the homing operation because it is necessary to initialize position information before starting normal operation.

- After the detection of the home position, initialize(Preset) the following object on the basis of its position.
 6062h(Position demand value) = 6064h(Position actual value) = 607Ch(Home offset)
 6063h(Position actual internal value) = 60FCh(Position demand internal value) = 0
- If a zero return is performed, position information will be initialized(preset).
 Therefore, it is necessary to reacquire the data (Touch probe position etc.) acquired to bass the old position informations.
- A change that is made to 607Ch (Home offset) during a homing operation will not be reflected in that homing operation.
 It is reflected from the next homing operation (initialization of position information at completion).

- 4.00 - If the home detection position is the edge of Switch signal(HOME, POT and NOT), assign to SI5, SI6 and SI7 to be each latch correction pin.
 If allocation is incorrect, Homing error will occur.

4.00 For more information, refer to Basic function specifications of the Technical document (SX-DSV02472).

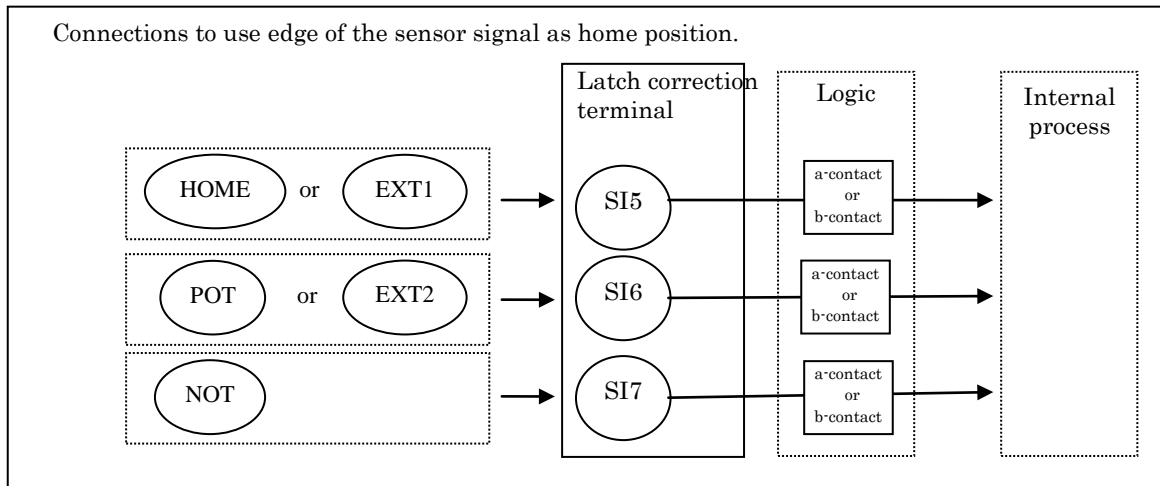

- The following terms that indicates in the figure each Method described below indicates the following content.

Index pulse	Z-phase signal of encoder(Set at full-closed control is external scale)
Home switch	Logic signal state of Origin proximity input(HOME)
Positive limit	Logic signal state of Positive direction over-travel inhibition input(POT)
Negative limit	Logic signal state of Negative direction over-travel inhibition input(NOT)

- For the operation command update (transmission), do input when approx. 100 ms has elapsed after the servo ON(Operation enabled).

- The sequence of the hm control mode is shown below.

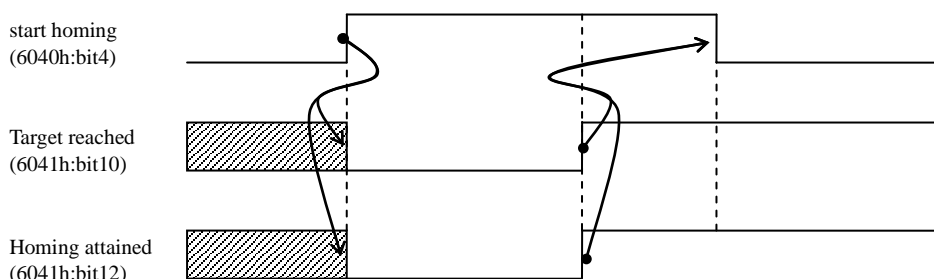

2.00 - If you perform a homing operation using the Index pulse, it is recommended that you set the 3722h(Communication function extended setup 1) bit7(In Z phase homing Over-travel inhibit input setup) to 1. The setting and, 3504h(Over-travel inhibit input setup) is set to 0 or 1, Index pulse movement amount becomes abnormal operation to the detection position, and to generate Err94.3 the (Home position return error protection 2) detects the inhibit input you can do the protection.
It should be noted that, if the 3504h (Over-travel inhibit input setup) is set to 2, detected in Err38.0(Over-travel inhibit input protection 1) of drive inhibit input occurs.

4.00 - Homing return speed limit function
When the home position detection, the motor returns overshoot distance (Homing return).
At this time, in the case of high response setting to position command and high speed (mode of 2 degree of freedom control, etc), if run homing return, the sound may occur when the homing is completed.

When the 3722h bit6(Homing return speed limit function enabled) is set to "1", homing return speed limit function is enabled.
If this function is enabled, homing return speed is limited by the 3793h(Homing return speed limit value).
The effect of reducing the occurrence of sound is expected.
Setting of 3722h bit6 and 3793h is reflected after changing the value and the driver control power reset.

If this function is enabled, there is a possibility that the time to homing completion extending.
If this function is disabled, homing return speed is limited by the maximum motor speed that the driver have internally.

When homing return speed exceeds the 3513h(Over-speed level setup), Err26.0(Over-speed protection) occurs.
When homing return speed exceeds the 3615h(2nd over-speed level setup), Err26.1(2nd over-speed protection) occurs.

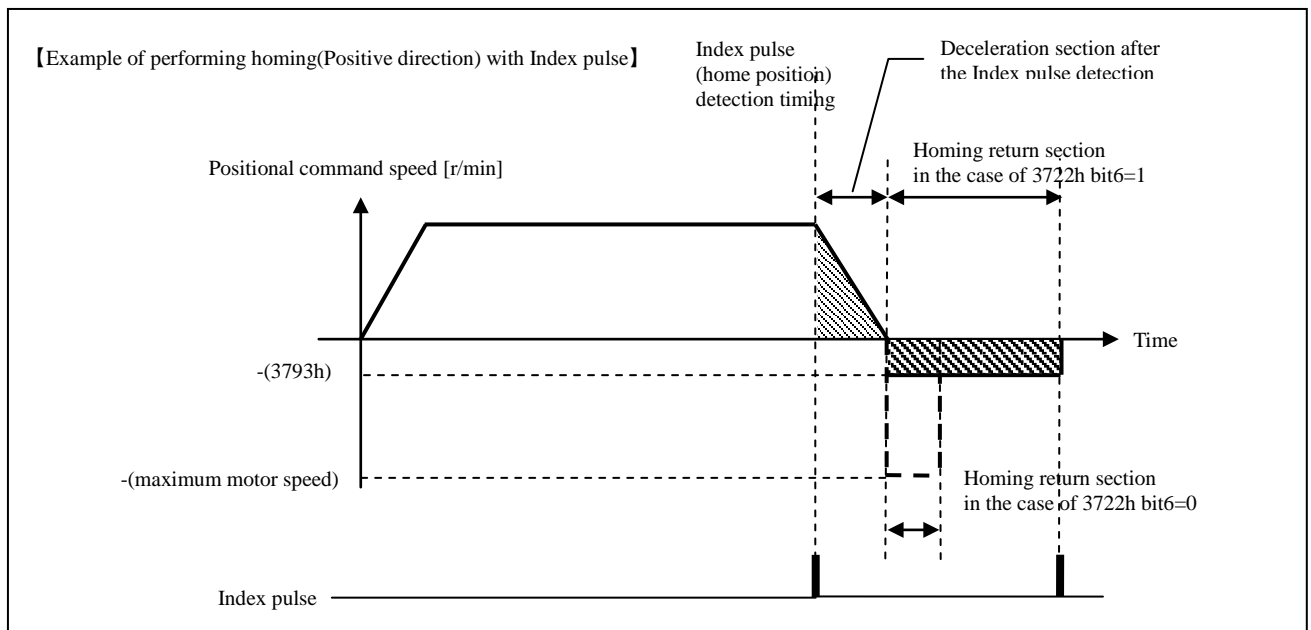

Index	Sub-Index	Name / Description	Units	Range	Data Type	Access	PDO	Op-mode	EEPROM
3722h	00h	Communication function extended setup 1 bit6 : Homing return speed limit function enabled 0 : Invalid 1 : Valid	—	-32768 – 32767	I16	rw	No	ALL	Yes
3793h	00h	Homing return speed limit value Sets the Homing return limit speed. When the set value is less than the internal minimum speed, it is limited by the internal minimum speed. When setting value is greater than the maximum motor speed, it will be limited by the maximum motor speed.	r/min	0 – 20000	I16	rw	No	hm	Yes

- Homing error occur conditions

In case of Homing operation, it becomes abnormalities (Homing error = 1) on condition of the following.

Homing Error Conditions	Detail
Started in absolute mode	Homing was started in absolute mode. *2)
Started when operation is not enabled	Homing was started when the PDS status is not in Operation enabled. *2) (excluding method 35, 37)
Started when target speed is 0	Homing was started when setting values for 6099h-01h and 6099h-02h were 0. *2) (Except for time when 6099h-02h of method 33 and 34 and 6099h-01h and 6099h-02h of method 35 and 37 are 0)
Limit switch detects both	In a Homing start-up or during Homing operation, Both Limit switch of Positive/Negative was detected. *3)
Penetrate the Limit switch	In the case of a method to reverse Limit switch During deceleration operation after detection for reversal of the rise of the Limit switch, detected a falling edge of the Limit switch
Penetrate the Home switch	In the case of a method to reverse Home switch During deceleration operation after detection for reversal of the rise of the Home switch, detected a falling edge of the Home switch
Installation relation between Home switch and Limit switch is unsuitable.	In the case of a method to reverse Home switch During deceleration operation after detection for reversal of the rise of the Home switch, detected a rising edge of the Limit switch
	In the case of a method to not reverse Limit switch Limit switch is detected during the Home switch search. *1)
Installation relation between Index pulse and Limit switch is unsuitable.	In the case of a method to detect the Index pulse Rising edge of Limit switch is detected during an Index pulse search.
	In the case of a method to not reverse Limit switch Limit switch is detected during the Index pulse search. *1)
Home switch and Limit switch have not been allocated.	HOME, POT and NOT have not been allocated to SI5, SI6, and SI7 respectively.

*1) Homing error is not detected when an operation to get out of the limitation by the limit switch (an operation in the opposite direction of the limited direction) is performed with the limit switch detected at the homing start-up *2).

*2) A homing start-up indicate a timing to change Bit4(start homing) of 6040h(Controlword) to 1 from 0.

*3) When 3504h (Over-travel inhibit input setup) = 0, Err38.0 (Over-travel inhibit input protection 1) occurs, instead of a homing error.

- Method 1

- This Method, if Negative limit switch is inactive, the initial operation direction turns into the negative direction.(An inactive state is shown in the state of low level by a figure)
- Home detection position is the first Index pulse detection position in the Positive side position of after a Negative limit signal becomes inactive.
- (See figure)
- When NOT is not assigned, Homing error will occur(Homing error = 1). 

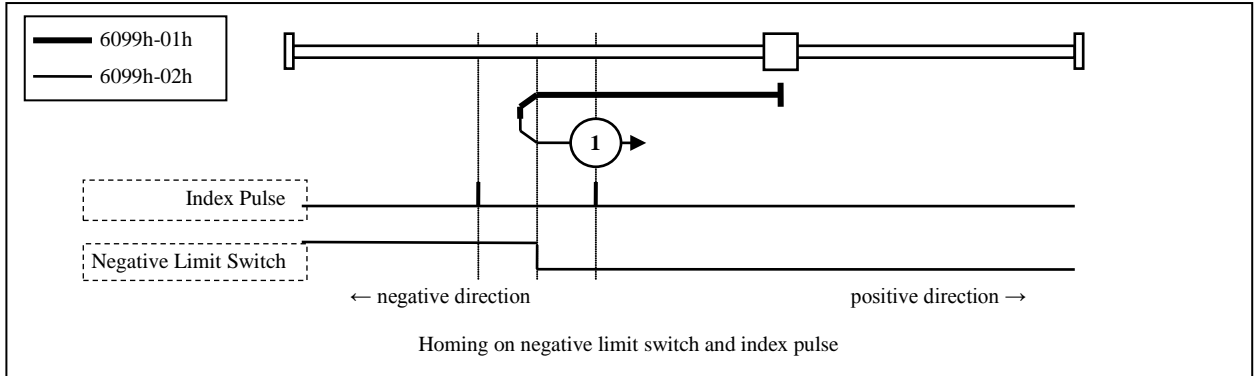

- Method 2

- This Method, if Positive limit switch is inactive, the initial operation direction turns into the positive direction. (An inactive state is shown in the state of low level by a figure)
- Home detection position is the first Index pulse detection position in the Negative side position of after a Positive limit signal becomes inactive.
- (See figure)
- When POT is not assigned, Homing error will occur (Homing error = 1).

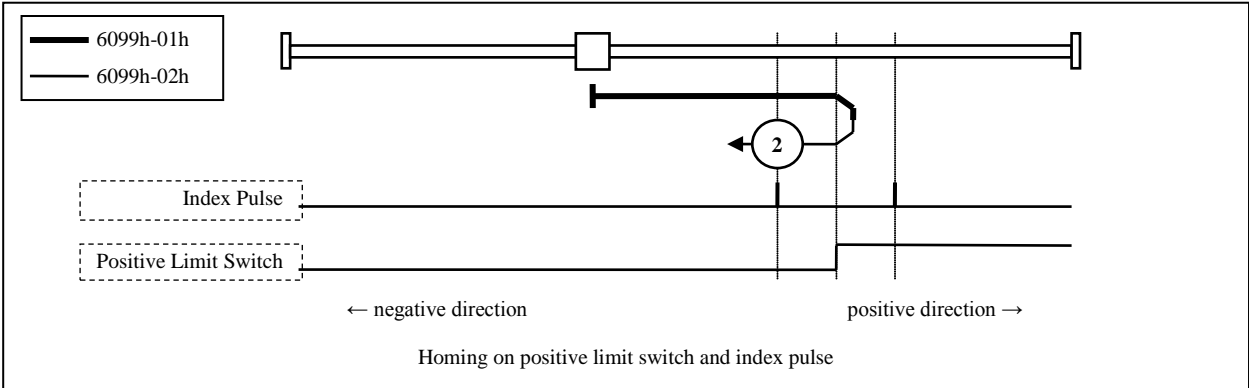

- Method 3, 4

- These Methods, the initial operation direction changes in the state of Home switch at startup
- Home detection position is the first Index pulse detection position in the Negative side or Positive side after the change of state of Home switch.

(See figure)

- When HOME is not assigned, Homing error will occur (Homing error = 1). 

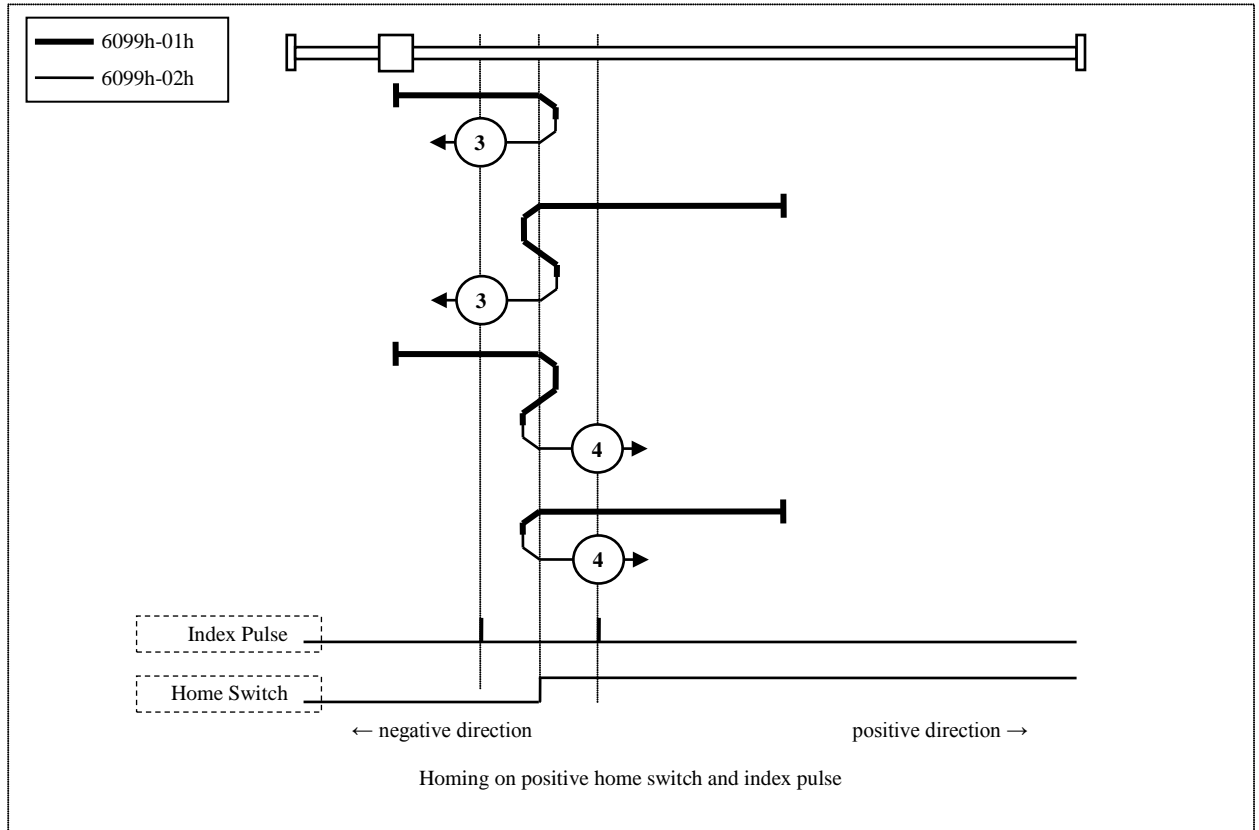

- Method 5, 6

- These Methods, the initial operation direction changes in the state of Home switch at startup
- Home detection position is the first Index pulse detection position in the Negative side or Positive side after the change of state of Home switch.

(See figure)

- When HOME is not assigned, Homing error will occur(Homing error = 1). 

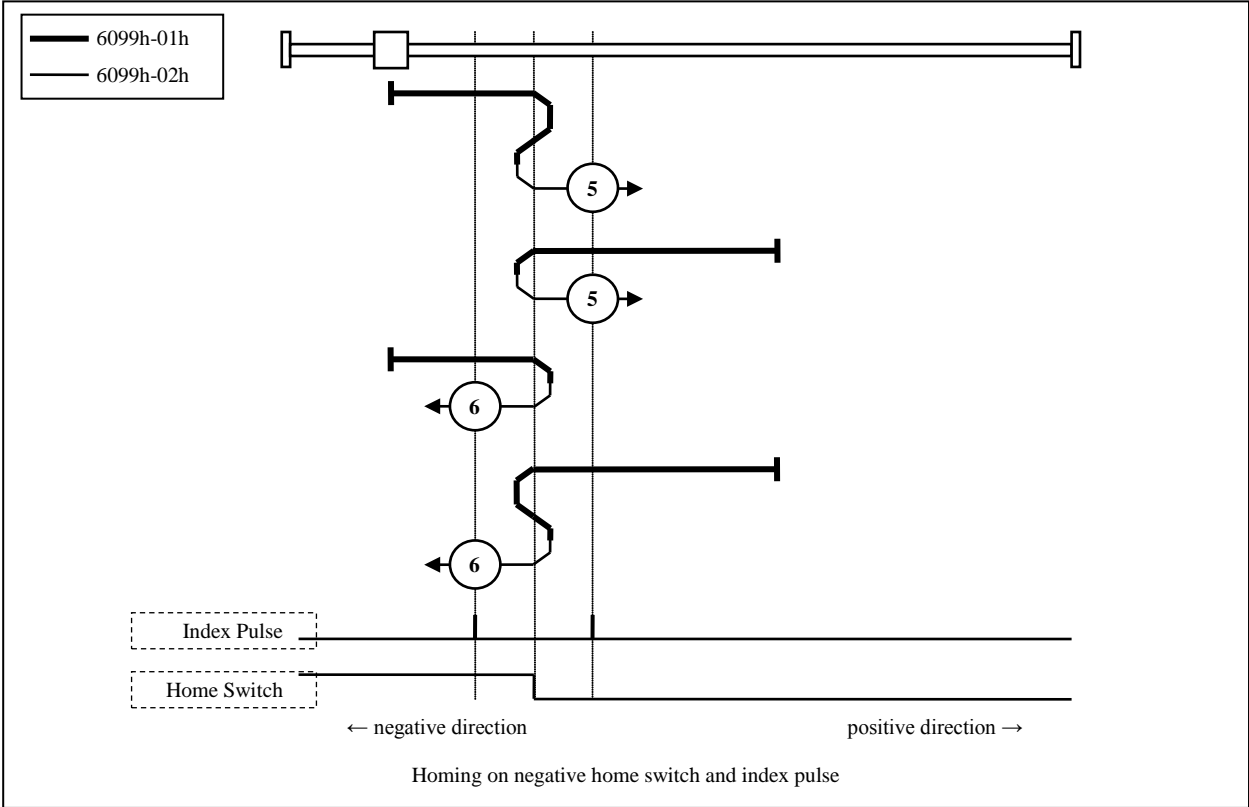

- Method 7, 8, 9, 10

- These Methods, use Home switch and Index pulse.
- Method 7 and 8 initial operation directions, when Home switch is active at the time of a start of operation, becomes the Negative direction.
- Method 9 and 10 initial operation directions, when Home switch is active at the time of a start of operation, becomes the Positive direction.
- Home detection position is the near Index pulse in the rising or falling edge of Home switch.
(See figure)
- When HOME and POT are not assigned, Homing error will occur(Homing error = 1). $\triangle_{2.00}$

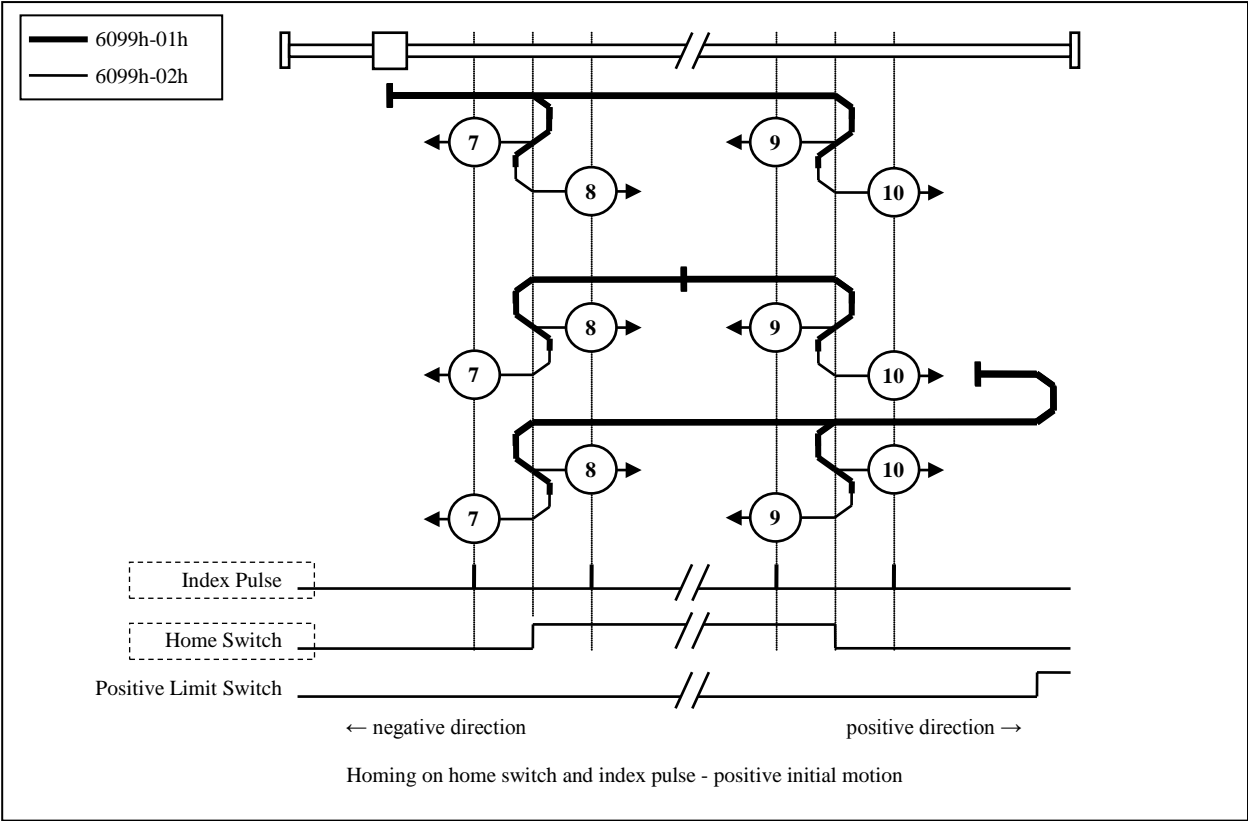

- Method 11, 12, 13, 14

- These Methods, use Home switch and Index pulse.
- Method 11 and 12 initial operation directions, when Home switch is active at the time of a start of operation, becomes the Positive direction.
- Method 13 and 14 initial operation directions, when Home switch is active at the time of a start of operation, becomes the Negative direction.
- Home detection position is the near Index pulse in the rising or falling edge of Home switch.
- (See figure)
- When HOME and NOT are not assigned, Homing error will occur(Homing error = 1). △_{2.00}

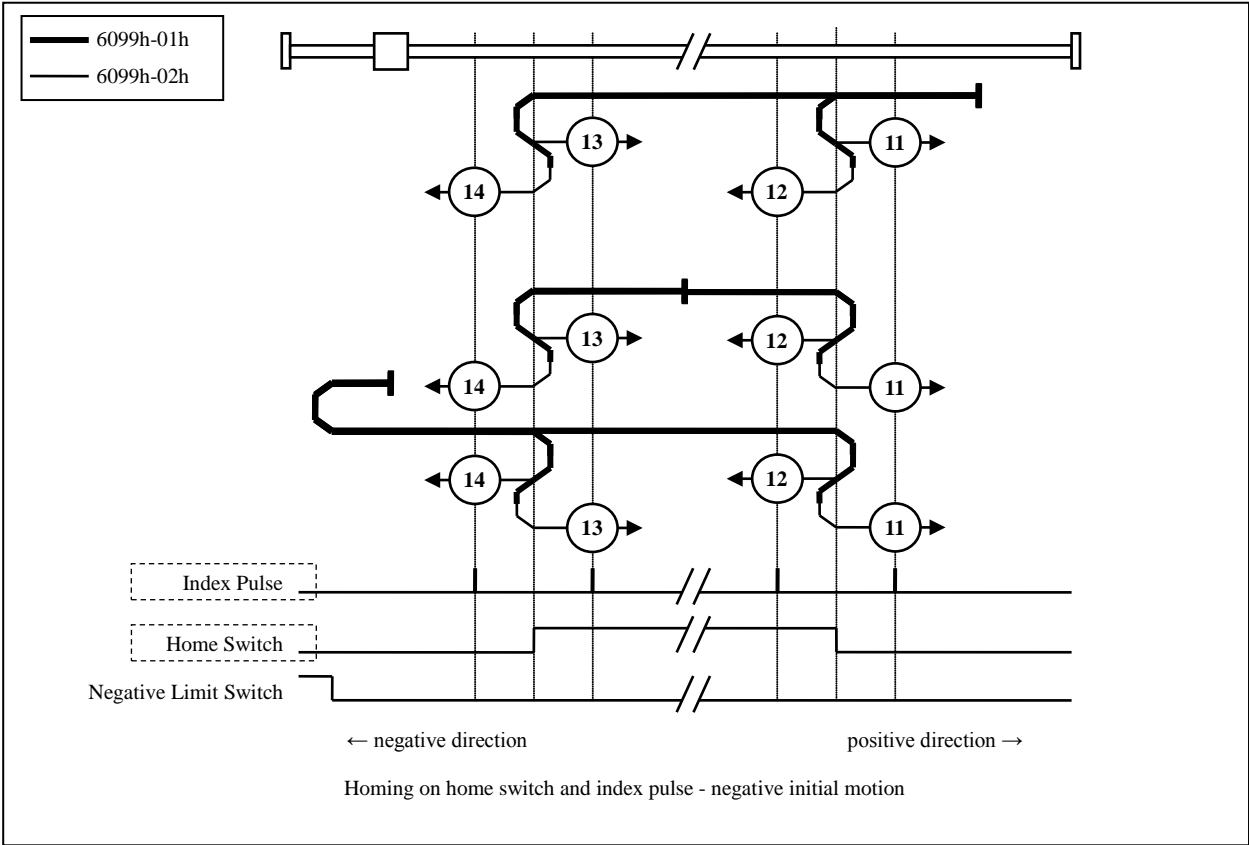

- Method 17

- This Method resembles Method1.
The difference is home detection position is not Index pulse. It is becoming the position where Limit switch changed.
(See figure)
- When NOT is not assigned, Homing error will occur(Homing error = 1).

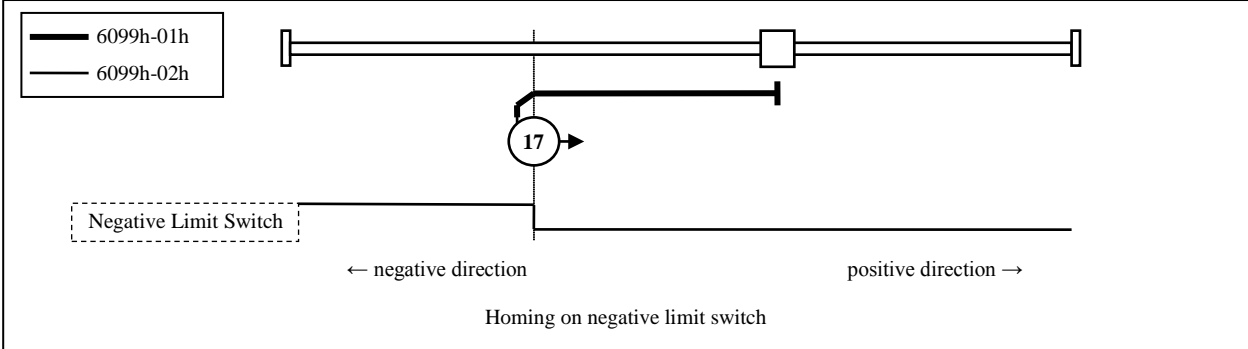

- Method 18

- This Method resembles Method2.
The difference is home detection position is not Index pulse. It is becoming the position where Limit switch changed.
(See figure)
- When NOT is not assigned, Homing error will occur(Homing error = 1).

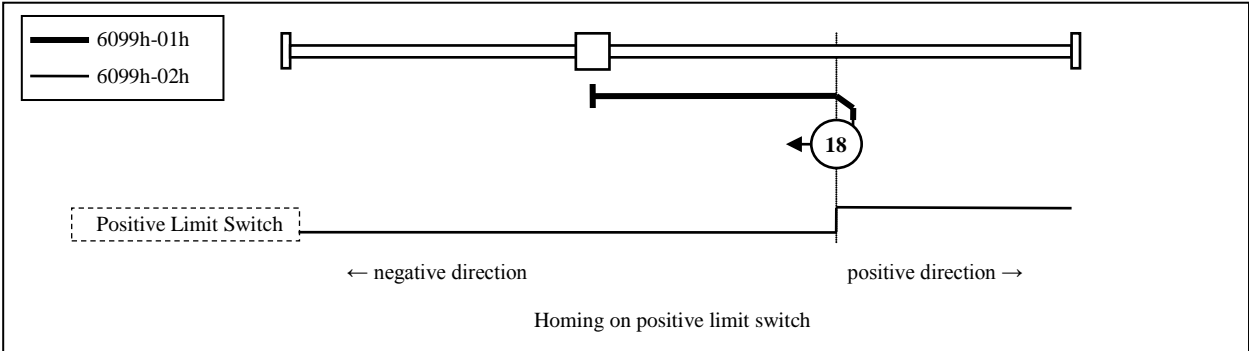

- Method 19, 20

- These Methods resembles Method3 and 4.

The difference is home detection position is not Index pulse. It is becoming the position where Home switch changed.

(See figure)

- When HOME is not assigned, Homing error will occur(Homing error = 1). 

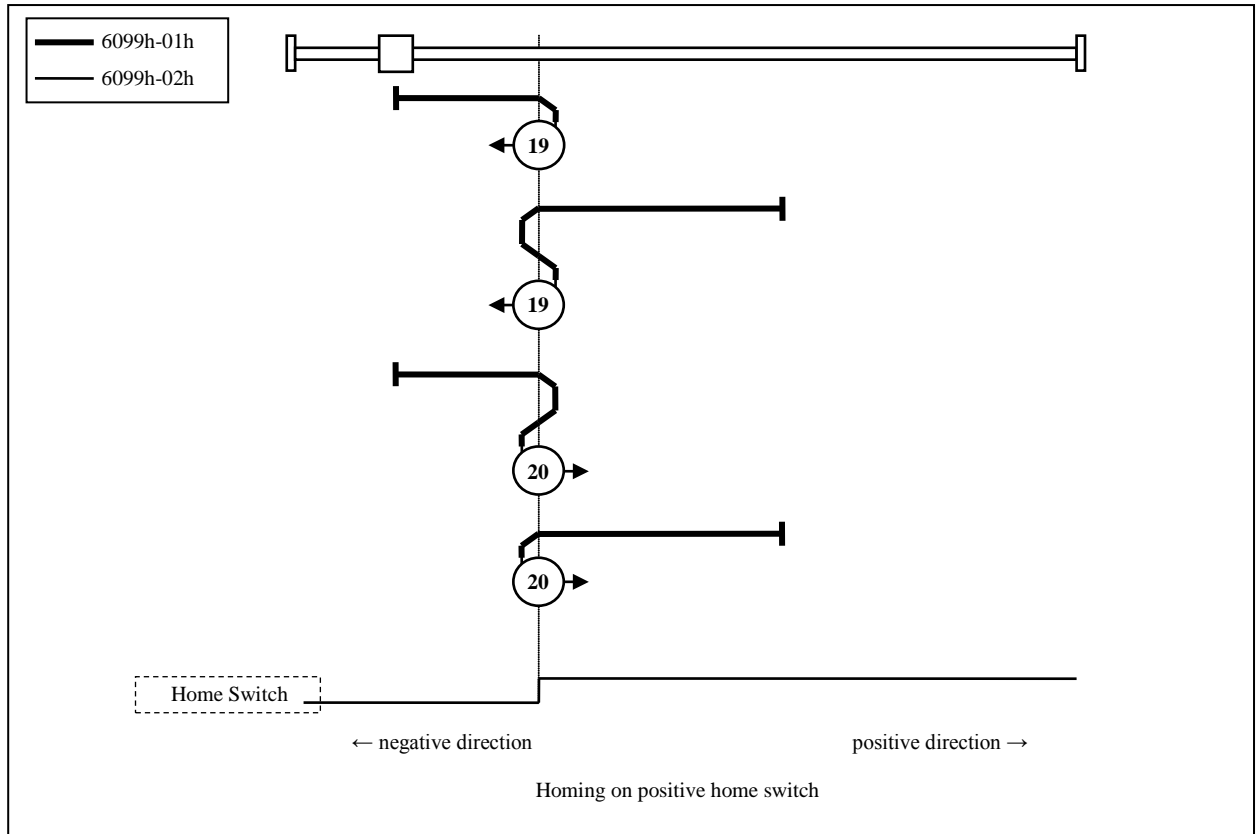

- Method 21, 22

- These Methods resembles Method5 and 6.
The difference is home detection position is not Index pulse. It is becoming the position where Home switch changed.

(See figure)

- When HOME is not assigned, Homing error will occur (Homing error = 1). $\triangle_{2.00}$

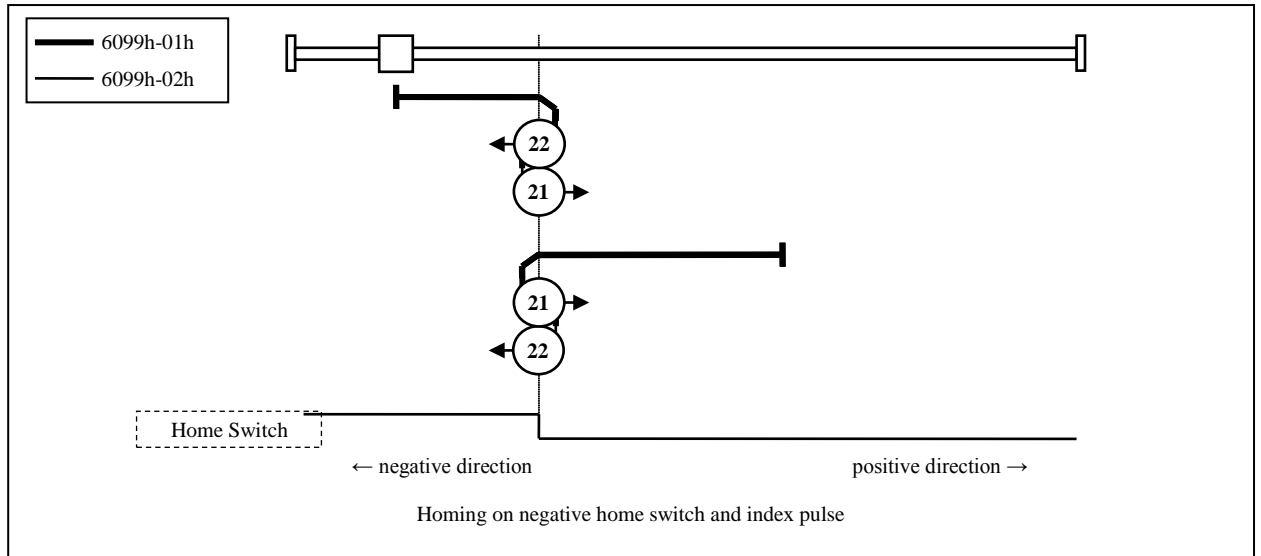

- Method 23, 24, 25, 26

- These Methods resembles Method 7,8,9 and 10.

The difference is home detection position is not Index pulse. It is becoming the position where Home switch changed.

(See figure)

- When HOME and POT are not assigned, Homing error will occur (Homing error = 1). 

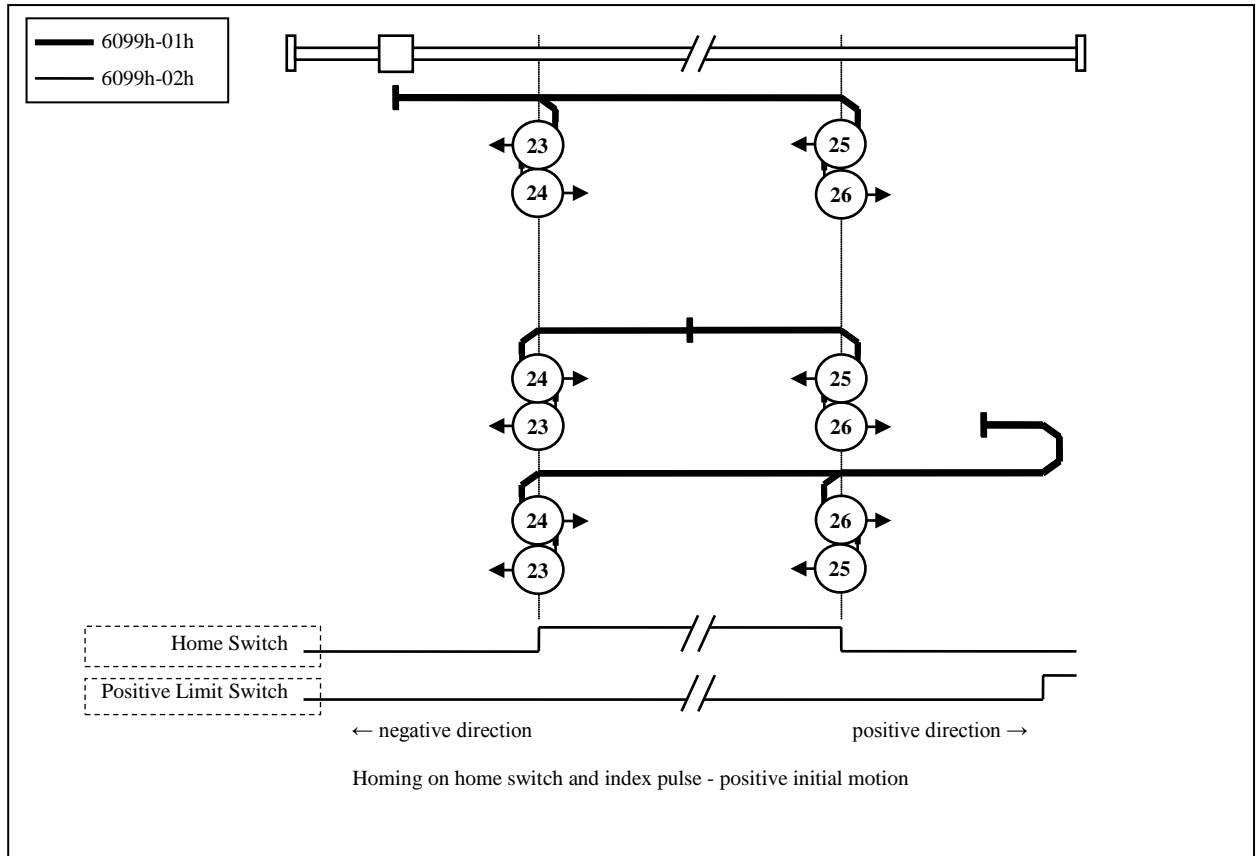

- Method 27, 28, 29, 30

- These Methods resembles Method11,12,13 and 14.
The difference is home detection position is not Index pulse. It is becoming the position where Home switch changed.

(See figure)

- When HOME and NOT are not assigned, Homing error will occur(Homing error = 1). 

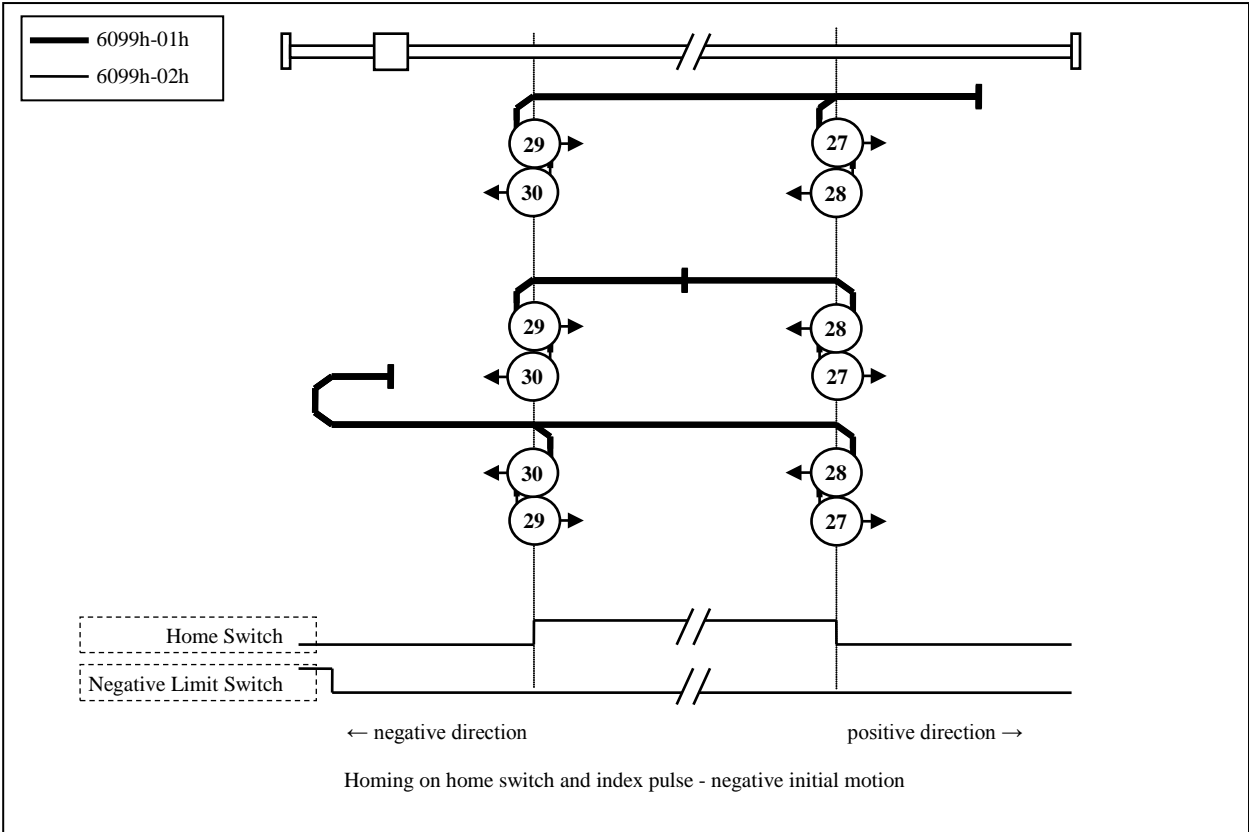

- Method 33, 34

- These Methods, use only Index pulse.
- Index pulse detected in operates in the direction shown in a figure is home detection position.
(See figure)

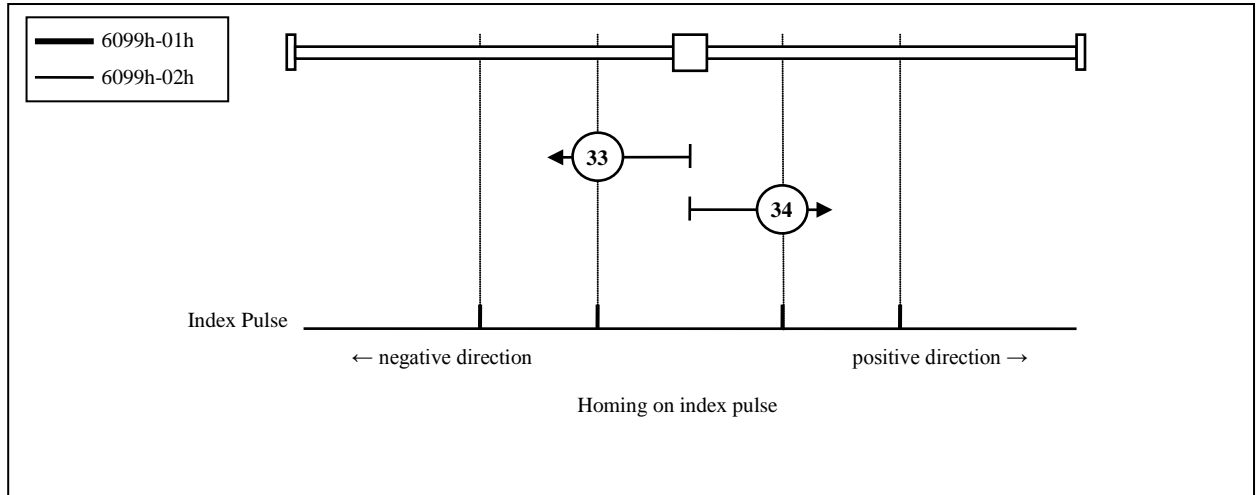

- Method 35, 37

- Used to set the coordinate system (position information) of the servo amplifier.
The following objects is initialized(Preset) on the basis of that position on homing startup.

$$6062h(\text{Position demand value}) = 6064h(\text{Position actual value}) = 607Ch(\text{Home offset})$$

$$6063h(\text{Position actual internal value}) = 60FCh(\text{Position demand internal value}) = 0$$

(NOTE) 607Ch(Home offset) is added to 6062h and 6064h.

- Practicable even if the PDS state is not Operation enabled.



- After 100ms or more expiration from stopping the command position, run Method 35 or 37.

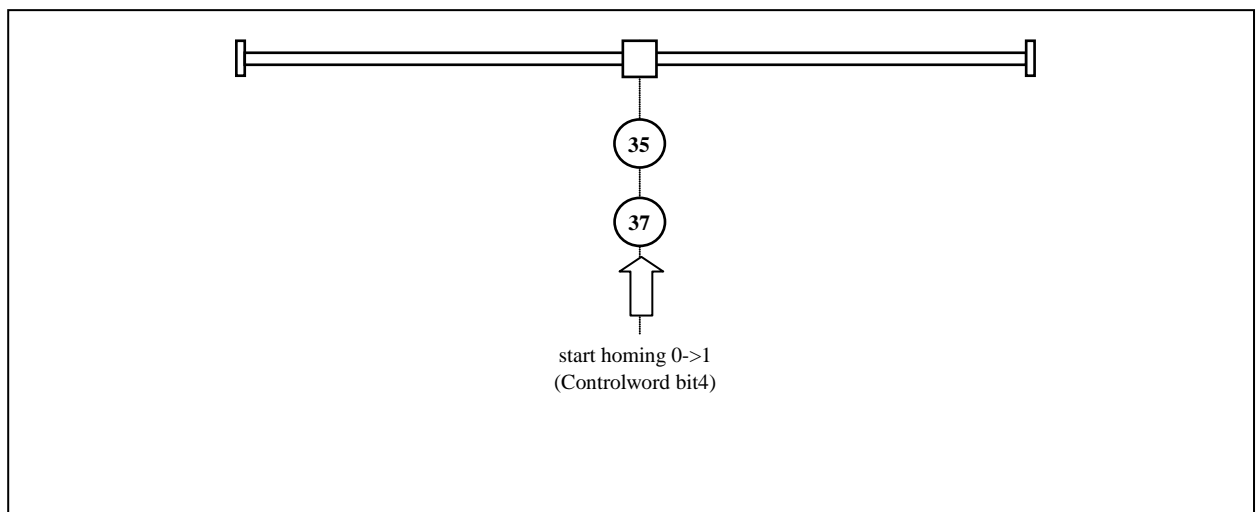

- Although Method35 and 37 are the same functions, use Method37 according to the ETG standard at the time of a new design.



6-7 Velocity Control Function

6-7-1 Common Velocity Control Function

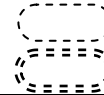
1) Velocity control block diagram

 Monitor data of PANATERM
 Monitor data of CiA402 object

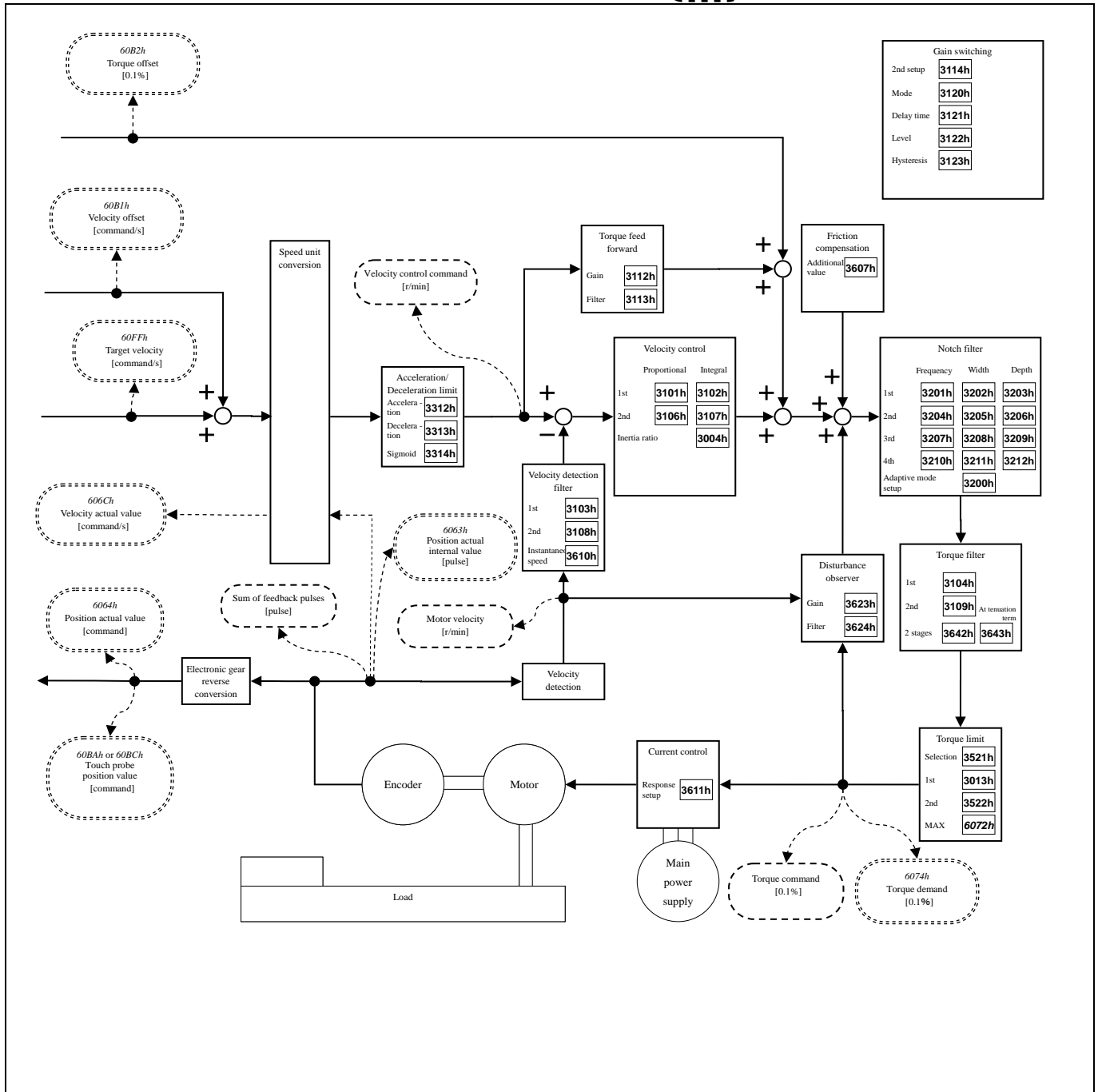

Velocity control block diagram

- *1) A slanting number (ex.:607Ah) shows the object number of EtherCAT.
- *2) A bold letter number (ex.:3100h) shows a parameter number.
- *3) Polarity was omitted.

2) Related objects common in velocity control (command & setup)

Index	Sub-Index	Name	Units	Range	Data Type	Access	PDO	Supported mode	
								pv	csv
6040h	00h	Controlword	-	0 - 65535	U16	rw	RxPDO	Yes	Yes
6072h	00h	Max torque	0.1%	0 - 65535	U16	rw	RxPDO	Yes	Yes
6080h	00h	Max motor speed	r/min	0 - 4294967295	U32	rw	RxPDO	Yes	Yes
60B1h	00h	Velocity offset	Command/s	-2147483648 - 2147483647	I32	rw	RxPDO	Yes	Yes
60B2h	00h	Torque offset	0.1%	-32768 - 32767	I16	rw	RxPDO	Yes	Yes
60FFh	00h	Target velocity	Command/s	-2147483648 - 2147483647	I32	rw	RxPDO	Yes	Yes

- Besides, there are related objects for each control mode.
Refer to the section "Related objects" of each control mode.
- The function of 6040h (Control word) can differ according to the control mode.
Refer to the section "Related objects" of each control mode.

- Velocity system

Index	Sub-Index	Name / Description	Units	Range	Data Type	Access	PDO	Opmode	EEPROM
6080h	00h	Max motor speed <ul style="list-style-type: none"> Set the maximum velocity of motor. Since this servo amplifier automatically sets the value based on the motor information, the setup is not necessary. The maximum value is limited by the maximum speed read out from the motor in internal processing. It is tq and cst and restricts speed with the preset value of this object. 	r/min	0 - 4294967295	U32	rw	RxPDO	ALL	Yes
60B1h	00h	Velocity offset <ul style="list-style-type: none"> Used as the velocity feed forward in the cyclic synchronous position mode (csp). Set the offset of the velocity command in the cyclic synchronous velocity mode (csv). (Note) The maximum value is limited by the 6080h (Max motor speed) in internal processing.	Command/s	-2147483648 - 2147483647	I32	rw	RxPDO	pp ip pv hm csp csv	Yes
60FFh	00h	Target velocity <ul style="list-style-type: none"> Set the target velocity. The internal target velocity is the sum of the preset value of this object and 60B1h (Velocity offset). The maximum value of the internal target velocity is limited by 6080h (Max motor speed) in internal processing. 	Command/s	-2147483648 - 2147483647	I32	rw	RxPDO	pv csv	No

- Torque system

Index	Sub-Index	Name / Description	Units	Range	Data Type	Access	PDO	Opmode	EEPROM
6072h	00h	Max torque <ul style="list-style-type: none"> Sets the maximum torque of the motor. The maximum value is limited by the maximum torque read out from the motor in internal processing. The maximum torque of the motor varies with the motor used. 	0.1%	0 - 65535	U16	rw	RxPDO	ALL	Yes
60B2h	00h	Torque offset <ul style="list-style-type: none"> Sets the offset of the torque command (torque feedforward). During slowdown in over-travel inhibition(in emergency stop), the torque feedforward level becomes 0. 	0.1%	0 - 4294967295	U32	rw	RxPDO	ALL	No

- Other

Index	Sub-Index	Name / Description	Units	Range	Data Type	Access	PDO	Op-mode	EEPROM
3724h	00h	Communication function extended setup 3 bit10 : Internal value state selection of objects 60B2h(Torque offset) in servo-off (Fall prevention function in the event of Servo-ON) 0: Clear 1: Updated with the set value of 60B2h	—	-32768 - 32767	I16	rw	No	ALL	Yes

3) Related objects common in velocity control (monitoring)

Index	Sub-Index	Name	Units	Range	Data Type	Access	PDO	Supported mode	
								pv	csv
4D29h	00h	Over load factor	0.1%	0 - 65535	U16	ro	TxPDO	Yes	Yes
6041h	00h	Statusword	-	0 - 65535	U16	ro	TxPDO	Yes	Yes
6063h	00h	Position actual internal value	pulse	-2147483648 - 2147483647	I32	ro	TxPDO	Yes	Yes
6064h	00h	Position actual value	Command	-2147483648 - 2147483647	I32	ro	TxPDO	Yes	Yes
606Bh	00h	Velocity demand value	Command/s	-2147483648 - 2147483647	I32	ro	TxPDO	Yes	Yes
6069h	00h	Velocity sensor actual value	-	-2147483648 - 2147483647	I32	ro	TxPDO	Yes	Yes
606Ch	00h	Velocity actual value	Command/s	-2147483648 - 2147483647	I32	ro	TxPDO	Yes	Yes
6074h	00h	Torque demand	0.1%	-32768 - 32767	I16	ro	TxPDO	Yes	Yes
6076h	00h	Motor rated torque	mNm	0 - 4294967295	U32	ro	TxPDO	Yes	Yes
6077h	00h	Torque actual value	0.1%	-32768 - 32767	I16	ro	TxPDO	Yes	Yes

- Besides, there are related objects for each control mode.
Refer to the section "Related objects" of each control mode.
- The function of 6041h (Status word) can differ according to each control mode.
Refer to the section "Related objects" of each control mode.

- Position system

Index	Sub-Index	Name / Description	Units	Range	Data Type	Access	PDO	Opmode	EEPROM
6063h	00h	Position actual internal value • Displays the actual position of the motor. The value is on an encoder basis during other than full-closed control, and on an external scale basis during full-closed control.	pulse	-2147483648 - 2147483647	I32	ro	TxPDO	ALL	No
6064h	00h	Position actual value • Displays the actual position of the motor.	Command	-2147483648 - 2147483647	I32	ro	TxPDO	ALL	No

- Velocity system

Index	Sub-Index	Name / Description	Units	Range	Data Type	Access	PDO	Opmode	EEPROM
6069h	00h	Velocity sensor actual value • Indicate sensor value of actual velocity. Return 0 always because this servo amplifier not supported.	—	-2147483648 - 2147483647	I32	ro	TxPDO	ALL	No
606Bh	00h	Velocity demand value • Displays internal command velocity.	Command/s	-2147483648 - 2147483647	I32	ro	TxPDO	pv csv	No
606Ch	00h	Velocity actual value • Displays the actual velocity of the motor.	Command/s	-2147483648 - 2147483647	I32	ro	TxPDO	ALL	No

- Torque system

Index	Sub-Index	Name / Description	Units	Range	Data Type	Access	PDO	Opmode	EEPROM
4.00	4D29h	Over load factor • The ratio [0.1%] to the rated load is displayed.	0.1%	0 - 65536	U16	ro	TxPDO	ALL	No
6074h	00h	Torque demand • Displays internal command torque.	0.1%	-32768 - 32767	I16	ro	TxPDO	ALL	No
6076h	00h	Motor rated torque • Automatically set the rated torque of the motor.	mNm	0 - 4294967295	U32	ro	TxPDO	ALL	No
6077h	00h	Torque actual value • Displays the actual torque. • It becomes a value equivalent to actual current value. • This output value is a reference value and does not guarantee an actual value.	0.1%	-32768 - 32767	I16	ro	TxPDO	ALL	No

6-7-2 Profile Velocity Mode (pv mode)

It is a velocity control mode to operate by designating the target velocity, addition-subtraction velocity, etc. and creating a position command in the servo amplifier.

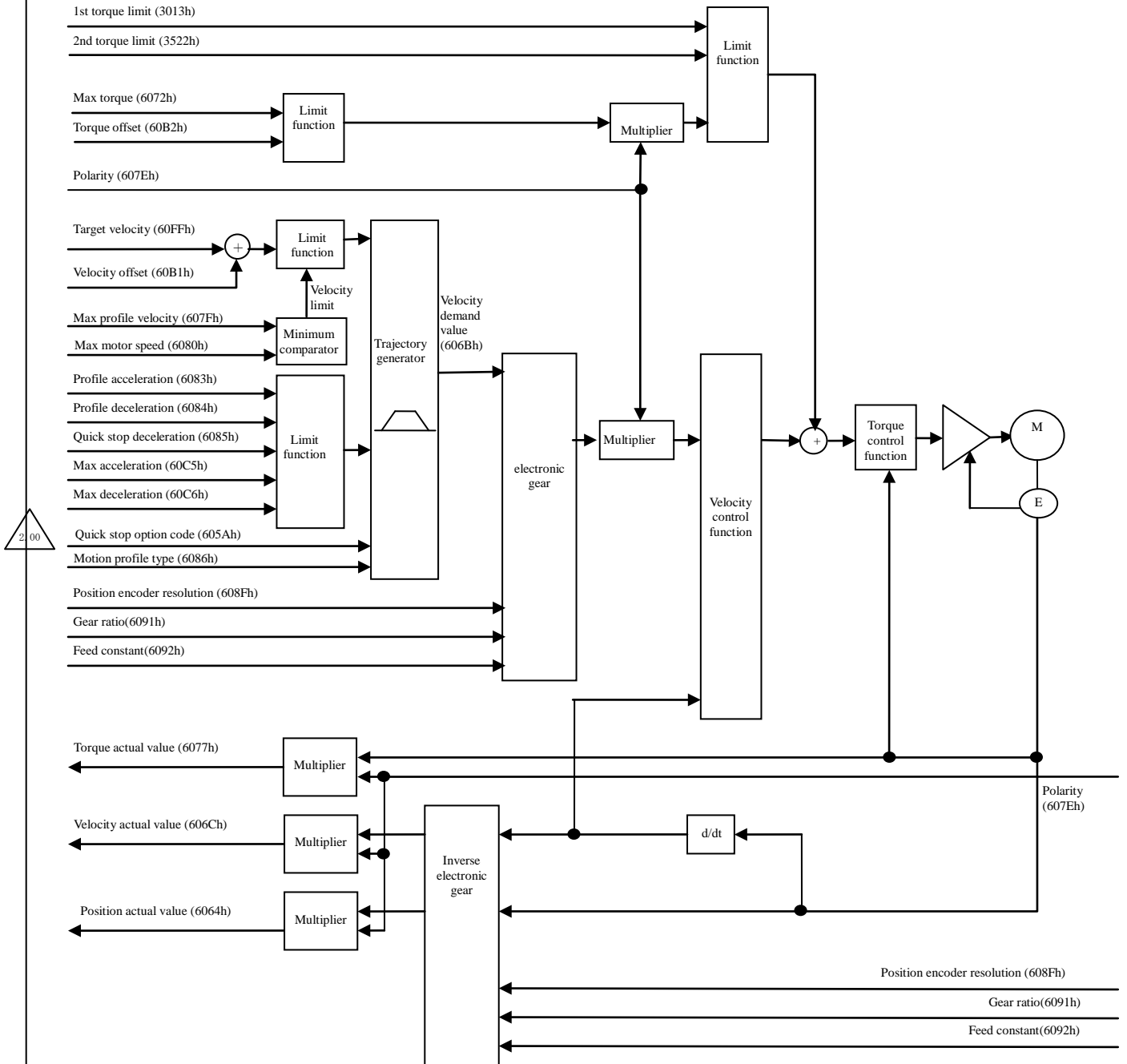

1) Objects related to pv mode (command & setup)

Index	Sub-Index	Name	Units	Range	Data Type	Access	PDO
6040h	00h	Controlword	-	0 - 65535	U16	rw	RxPDO
606Ah	00h	Sensor selection code	-	-32768 - 32767	I16	ro	TxPDO
607Fh	00h	Max profile velocity	Command/s	0 - 4294967295	U32	rw	RxPDO
6083h	00h	Profile acceleration	Command/s ²	0 - 4294967295	U32	rw	RxPDO
6084h	00h	Profile deceleration	Command/s ²	0 - 4294967295	U32	rw	RxPDO
60C5h	00h	Max acceleration	Command/s ²	0 - 4294967295	U32	rw	RxPDO
60C6h	00h	Max deceleration	Command/s ²	0 - 4294967295	U32	rw	RxPDO







- Besides, there are related objects common to the velocity control.

For more information, refer to section 6-7-1.

Index	Sub-Index	Name	Units	Range	Data Type	Access	PDO
6072h	00h	Max torque	0.1%	0 - 65535	U16	rw	RxPDO
6080h	00h	Max motor speed	r/min	0 - 4294967295	U32	rw	RxPDO
60B1h	00h	Velocity offset	Command/s	-2147483648 - 2147483647	I32	rw	RxPDO
60B2h	00h	Torque offset	0.1%	-32768 - 32767	I16	rw	RxPDO
60FFh	00h	Target velocity	Command/s	-2147483648 - 2147483647	I32	rw	RxPDO

- There is a related object of common motion as well.

For more information, refer to section 6-9.

Index	Sub-Index	Name	Units	Range	Data Type	Access	PDO
6007h	00h	Abort connection option code	—	0 - 3	I16	rw	No
605Ah	00h	Quick stop option code	—	0 - 7	I16	rw	No
605Bh	00h	Shutdown option code	—	0 - 1	I16	rw	No
605Ch	00h	Disable operation option code	—	0 - 1	I16	rw	No
605Dh	00h	Halt option code	—	1 - 3	I16	rw	No
605Eh	00h	Fault reaction option code	—	0 - 2	I16	rw	No
607Bh	-	Position range limit	-	-	-	-	-
	00h	Highest sub-index supported	-	2	U8	ro	No
	01h	Min position range limit	Command	-2147483648 – 2147483647	I32	rw	RxPDO
	02h	Max position range limit	Command	-2147483648 – 2147483647	I32	rw	RxPDO
607Ch	00h	Home offset	Command	-2147483648 – 2147483647	I32	rw	RxPDO
607Eh	00h	Polarity	-	0 – 255	U8	rw	No
6085h	00h	Quick stop deceleration	Command/s ²	0 – 4294967295	U32	rw	RxPDO
6086h	00h	Motion profile type	-	-32768 – 32767	I16	rw	RxPDO
608Fh	-	Position encoder resolution	-	-	-	-	-
	00h	Highest sub-index supported	-	2	U8	ro	No
	01h	Encoder increments	pulse	 1 – 4294967295	U32	ro	No
	02h	Motor revolutions	r (motor)	 1 – 4294967295	U32	ro	No
6091h	-	Gear ratio	-	-	-	-	-
	00h	Number of entries	-	2	U8	ro	No
	01h	Motor revolutions	r (motor)	 1 – 4294967295	U32	rw	No
	02h	Shaft revolutions	r (shaft)	 1 – 4294967295	U32	rw	No
6092h	-	Feed constant	-	-	-	-	-
	00h	Highest sub-index supported	-	2	U8	ro	No
	01h	Feed	Command	 1 – 4294967295	U32	rw	No
	02h	Shaft revolutions	r (shaft)	 1 – 4294967295	U32	rw	No
60A3h	00h	Profile jerk use	-	1 - 2	U8	rw	No
60A4h	-	Profile jerk	-	-	-	-	-
	00h	Highest sub-index supported	-	1 - 2	U8	ro	No
	01h	Profile jerk 1	Command/s ³	0 – 4294967295	U32	rw	No
	02h	Profile jerk 2	Command/s ³	0 – 4294967295	U32	rw	No
60B8h	00h	Touch probe function	-	0 - 65535	U16	rw	RxPDO
60FEh	-	Digital outputs	-	-	-	-	-
	00h	Number of entries	-	2	U8	ro	No
	01h	Physical outputs	-	0 - 4294967295	U32	rw	RxPDO
	02h	Bit mask	-	0 - 4294967295	U32	rw	RxPDO

- Controlword (6040h) <Functions in pv mode>

Index	Sub-Index	Name / Description	Units	Range	Data Type	Access	PDO	Opmode	EEPROM			
6040h	00h	Controlword • Set a command to a servo amplifier including the PDS state transition.	-	0 - 65535	U16	rw	RxPDO	ALL	No			
Bit information details												
		15 - 10	9	8	7	6	5	4	3	2	1	0
		r	oms r	h	fr	r	r	r	eo	qs	ev	so
		r	= reserved (not supported)				fr		= fault reset			
		oms	= operation mode specific (control mode dependent bit)				eo		= enable operation			
		h	= halt				qs		= quick stop			
							ev		= enable voltage			
							so		= switch on			

* Note: The pv mode does not use the oms bit.

- Velocity system

Index	Sub-Index	Name / Description	Units	Range	Data Type	Access	PDO	Op-mode	EEPROM
606Ah	00h	Sensor selection code <ul style="list-style-type: none"> Set the sensor selection code. Since this servo amplifier does not support velocity sensor, always 0 is set. 0: Actual position from the position sensor 1: Actual velocity from the velocity sensor (not supported)	-	-32768 - 32767	I16	ro	TxPDO	pv	No
607Fh	00h	Max profile velocity <ul style="list-style-type: none"> Set the velocity limit in the profile position mode (pp), homing position mode (hm), interpolating position mode (ip), and profile velocity mode (pv). The maximum value is limited by the (Max motor speed) 6080h in internal processing. 	Command/s	0 - 4294967295	U32	rw	RxPDO	pp hm ip pv	Yes

- Acceleration and deceleration system

Index	Sub-Index	Name / Description	Units	Range	Data Type	Access	PDO	Op-mode	EEPROM
6083h	00h	Profile acceleration <ul style="list-style-type: none"> Set the profile acceleration. If it is set to 0, internal processing is treated as 1. 	Command/s ²	0 - 4294967295	U32	rw	RxPDO	pp ip pv	Yes
6084h	00h	Profile deceleration <ul style="list-style-type: none"> Set the profile deceleration. If it is set to 0, internal processing is treated as 1. 	Command/s ²	0 - 4294967295	U32	rw	RxPDO	pp ip pv	Yes
60C5h	00h	Max acceleration <ul style="list-style-type: none"> Set the maximum acceleration. If it is set to 0, internal processing is treated as 1. 	Command/s ²	0 - 4294967295	U32	rw	RxPDO	pp hm ip pv	Yes
60C6h	00h	Max deceleration <ul style="list-style-type: none"> Set the maximum deceleration. If it is set to 0, internal processing is treated as 1. 	Command/s ²	0 - 4294967295	U32	rw	RxPDO	pp hm ip pv	Yes

2) Objects related to pv mode (monitoring)

Index	Sub-Index	Name	Units	Range	Data Type	Access	PDO
6041h	00h	Statusword	-	0 - 65535	U16	ro	TxPDO
606Dh	00h	Velocity window	Command/s	0 - 65535	U16	rw	RxPDO
606Eh	00h	Velocity window time	1 ms	0 - 65535	U16	rw	RxPDO
606Fh	00h	Velocity threshold	Command/s	0 - 65535	U16	rw	RxPDO
6070h	00h	Velocity threshold time	1ms	0 - 65535	U16	rw	RxPDO

- Besides, there are related objects common to the velocity control.

For more information, refer to section 6-7-1.

Index	Sub-Index	Name	Units	Range	Data Type	Access	PDO
6063h	00h	Position actual internal value	pulse	-2147483648 - 2147483647	I32	ro	TxPDO
6064h	00h	Position actual value	Command	-2147483648 - 2147483647	I32	ro	TxPDO
6069h	00h	Velocity sensor actual value	-	-2147483648 - 2147483647	I32	ro	TxPDO
606Bh	00h	Velocity demand value	Command/s	-2147483648 - 2147483647	I32	ro	TxPDO
606Ch	00h	Velocity actual value	Command/s	-2147483648 - 2147483647	I32	ro	TxPDO
6074h	00h	Torque demand	0.1%	-32768 - 32767	I16	ro	TxPDO
6076h	00h	Motor rated torque	mNm	0 - 4294967295	U32	ro	TxPDO
6077h	00h	Torque actual value	0.1%	-32768 - 32767	I16	ro	TxPDO

- There is a related object of common motion as well.

For more information, refer to section 6-9.

Index	Sub-Index	Name	Units	Range	Data Type	Access	PDO
603Fh	00h	Error code	-	0 - 65535	U16	ro	TxPDO
60B9h	00h	Touch probe status	-	0 - 65535	U16	ro	TxPDO
60BAh	00h	Touch probe pos1 pos value	Command	-2147483648 - 2147483647	I32	ro	TxPDO
60BBh	00h	Touch probe pos1 neg value	Command	-2147483648 - 2147483647	I32	ro	TxPDO
60BCh	00h	Touch probe pos2 pos value	Command	-2147483648 - 2147483647	I32	ro	TxPDO
60BDh	00h	Touch probe pos2 neg value	Command	-2147483648 - 2147483647	I32	ro	TxPDO
60FDh	00h	Digital inputs	-	0 - 4294967295	U32	ro	TxPDO

- Statusword (6041h) <Functions in pv mode>

Index	Sub-Index	Name / Description	Units	Range	Data Type	Access	PDO	Opmode	EEPROM																																																																																
6041h	00h	Statusword • Displays the servo amplifier state. Bit information details	-	0 - 65535	U16	ro	TxPDO	ALL	No																																																																																
		<table border="1"> <thead> <tr> <th>15 - 14</th> <th>13</th> <th>12</th> <th>11</th> <th>10</th> <th>9</th> <th>8</th> <th>7</th> <th>6</th> <th>5</th> <th>4</th> <th>3</th> <th>2</th> <th>1</th> <th>0</th> </tr> </thead> <tbody> <tr> <td colspan="2"></td> <td colspan="2">oms</td> <td colspan="2"></td> <td colspan="2"></td> <td colspan="2"></td> <td colspan="2"></td> <td colspan="2"></td> <td colspan="2"></td> </tr> <tr> <td>r</td> <td>max slippage error</td> <td>speed</td> <td>ila</td> <td>target reached</td> <td>rm</td> <td>r</td> <td>w</td> <td>sod</td> <td>qs</td> <td>ve</td> <td>f</td> <td>oe</td> <td>so</td> <td>rtso</td> </tr> </tbody> </table> <table> <tr> <td>r</td> <td>= reserved (not supported)</td> <td>w</td> <td>= warning</td> </tr> <tr> <td>oms</td> <td>= operation mode specific (control mode dependent bit)</td> <td>sod</td> <td>= switch on disabled</td> </tr> <tr> <td>ila</td> <td>= internal limit active</td> <td>qs</td> <td>= quick stop</td> </tr> <tr> <td>rm</td> <td>= remote</td> <td>ve</td> <td>= voltage enabled</td> </tr> <tr> <td></td> <td></td> <td>f</td> <td>= fault</td> </tr> <tr> <td></td> <td></td> <td>oe</td> <td>= operation enabled</td> </tr> <tr> <td></td> <td></td> <td>so</td> <td>= switched on</td> </tr> <tr> <td></td> <td></td> <td>rtso</td> <td>= ready to switch on</td> </tr> </table>	15 - 14	13	12	11	10	9	8	7	6	5	4	3	2	1	0			oms														r	max slippage error	speed	ila	target reached	rm	r	w	sod	qs	ve	f	oe	so	rtso	r	= reserved (not supported)	w	= warning	oms	= operation mode specific (control mode dependent bit)	sod	= switch on disabled	ila	= internal limit active	qs	= quick stop	rm	= remote	ve	= voltage enabled			f	= fault			oe	= operation enabled			so	= switched on			rtso	= ready to switch on									
15 - 14	13	12	11	10	9	8	7	6	5	4	3	2	1	0																																																																											
		oms																																																																																							
r	max slippage error	speed	ila	target reached	rm	r	w	sod	qs	ve	f	oe	so	rtso																																																																											
r	= reserved (not supported)	w	= warning																																																																																						
oms	= operation mode specific (control mode dependent bit)	sod	= switch on disabled																																																																																						
ila	= internal limit active	qs	= quick stop																																																																																						
rm	= remote	ve	= voltage enabled																																																																																						
		f	= fault																																																																																						
		oe	= operation enabled																																																																																						
		so	= switched on																																																																																						
		rtso	= ready to switch on																																																																																						

bit13 (operation mode specific):

Bit	Name	Value	Definition
13	max slippage error	-	(not supported)

bit10 (target reached(Velocity reached)):

When the difference between 60FFh (Target velocity) and 60B1h (Velocity offset) is in the range set by 606Dh (Velocity window) and the time set by 606Eh (Velocity window time) has elapsed, bit 10 of 6041h (Statusword) is set to 1.

Bit	Name	Value	Definition
10	target reached	0	halt=0 (during normal operation) : Speed control not yet completed halt=1 (during stop by halt) : During axis deceleration
		1	halt=0 (during normal operation) : Speed control completed halt=1 (during stop by halt) : Axis stop (Axis speed is 0.)

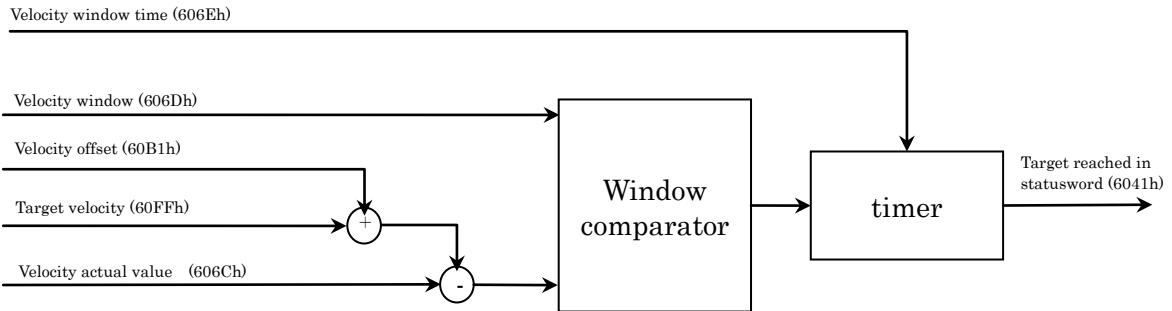

<Velocity reached (functional overview)>

Index	Sub-Index	Name / Description	Units	Range	Data Type	Access	PDO	Opmode	EEPROM
606Dh	00h	Velocity window <ul style="list-style-type: none"> Set the threshold where bit 10 (Target reached) of 6041h (Statusword) will be 1 when the difference between the sum of 60FFh (Target velocity) and 60B1h (Velocity offset), and 606Ch (Velocity actual value), on the other hand, is within the range set by this parameter and the time set by 606Eh (Velocity window time) has elapsed. If the velocity deviation is out of the values set by this parameter, the bit 10 of 6041h will be 0. 	Command/s	0 - 65535	U16	rw	RxPDO	pv	Yes
606Eh	00h	Velocity window time <ul style="list-style-type: none"> Set the time from the point when the difference between the sum of 60FFh (Target velocity) and 60B1h (Velocity offset), and 606Ch (Velocity actual value), on the other hand, falls within the range set by 606Dh (Velocity window) until bit 10 (target reached) of 6041h (Statusword) becomes 1. 	1 ms	0 - 65535	U16	rw	RxPDO	pv	Yes

bit12 (speed):

When 606Ch (Velocity actual value) exceeds the value set in 606Fh (Velocity threshold) and the time set by 6070h (Velocity threshold time) has elapsed, bit 12 of 6041h (Statusword) changes to 0.

When 606Ch (Velocity actual value) becomes lower than the value set in 606Fh (Velocity threshold), bit 12 of 6041h (Statusword) changes to 1, which indicates that the motor has stopped.

Bit	Name	Value	Definition
12	speed	0	Motor is operating
		1	Motor is not operating

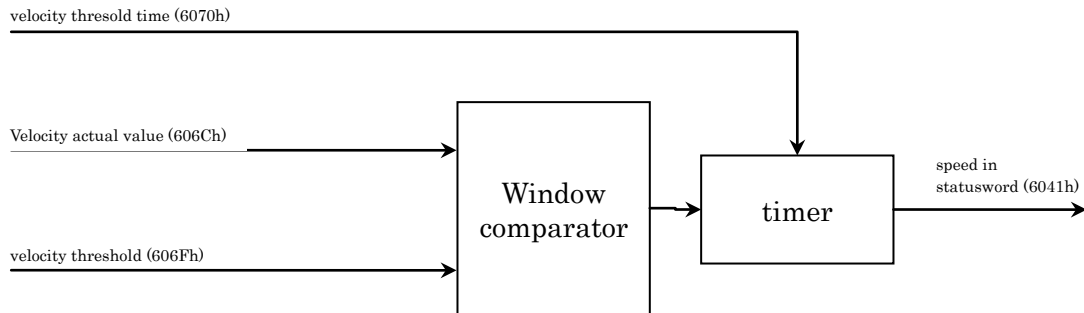

<Speed (functional overview)>

Index	Sub-Index	Name / Description	Units	Range	Data Type	Access	PDO	Opmode	EEPROM
606Fh	00h	Velocity threshold <ul style="list-style-type: none"> Set the threshold where bit 12 (speed) of 6041h (Statusword) becomes 0 when 606Ch (Velocity actual value) exceeds the value set to this parameter and the time set in 6070h (Velocity threshold time) has elapsed. When the velocity becomes lower than the value set in this parameter, bit 12 of 6041 (Statusword) changes to 1. 	Command/s	0 - 65535	U16	rw	RxPDO	pv	Yes
6070h	00h	Velocity threshold time <ul style="list-style-type: none"> Set the time from the point when 606Ch (Velocity actual value) exceeds the value set to 606Fh (Velocity threshold) until the point when bit 12 of 6041h (Statusword) changes to 0. 	1ms	0 - 65535	U16	rw	RxPDO	pv	Yes

3) Operations of pv mode

Profile velocity control mode generates a speed command value according to the following parameters.

- Target velocity (60FFh)
- Velocity offset (60B1h)
- Profile acceleration (6083h)
- Profile deceleration (6084h)

Target velocity is additional value of the 60FFh (Target velocity) and 60B1h(Velocity offset).

For the operation command update (transmission), do input when approx. 100 ms has elapsed after the servo ON(Operation enabled command).



There are various sensors for velocity detection. The MINAS-A5B series detects the position and velocity by using an encoder (position sensor).

As the monitoring function, the Velocity actual value (606Ch) provides the information to upper system.

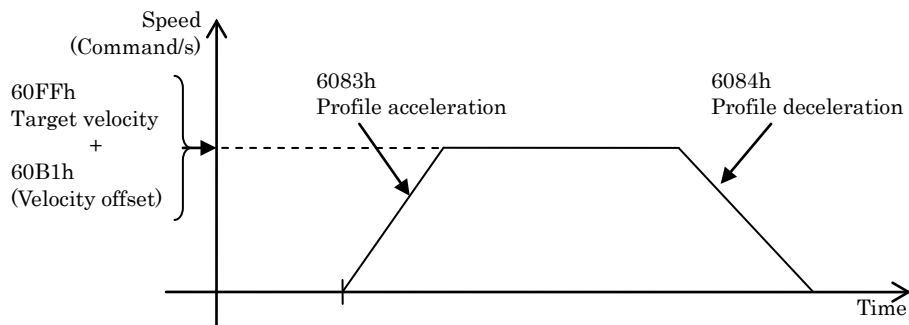

Note) - The sum of 60FFh (Target velocity) and 60B1h (Velocity offset) is limited by 607Fh(Max profile velocity) and 6080h (Max motor speed).

However, a change that is made to the value of 607Fh(Max profile velocity) and 6080h (Max motor speed) during operation will not be reflected in that operation.

6-7-3 Cyclic Velocity Mode (csv mode)

It is a velocity control mode to operate by creating a command velocity in the upper system (master) and updating (transmitting) the command velocity in an interpolation cycle.
Use it in the DC or SM2 synchronization mode.

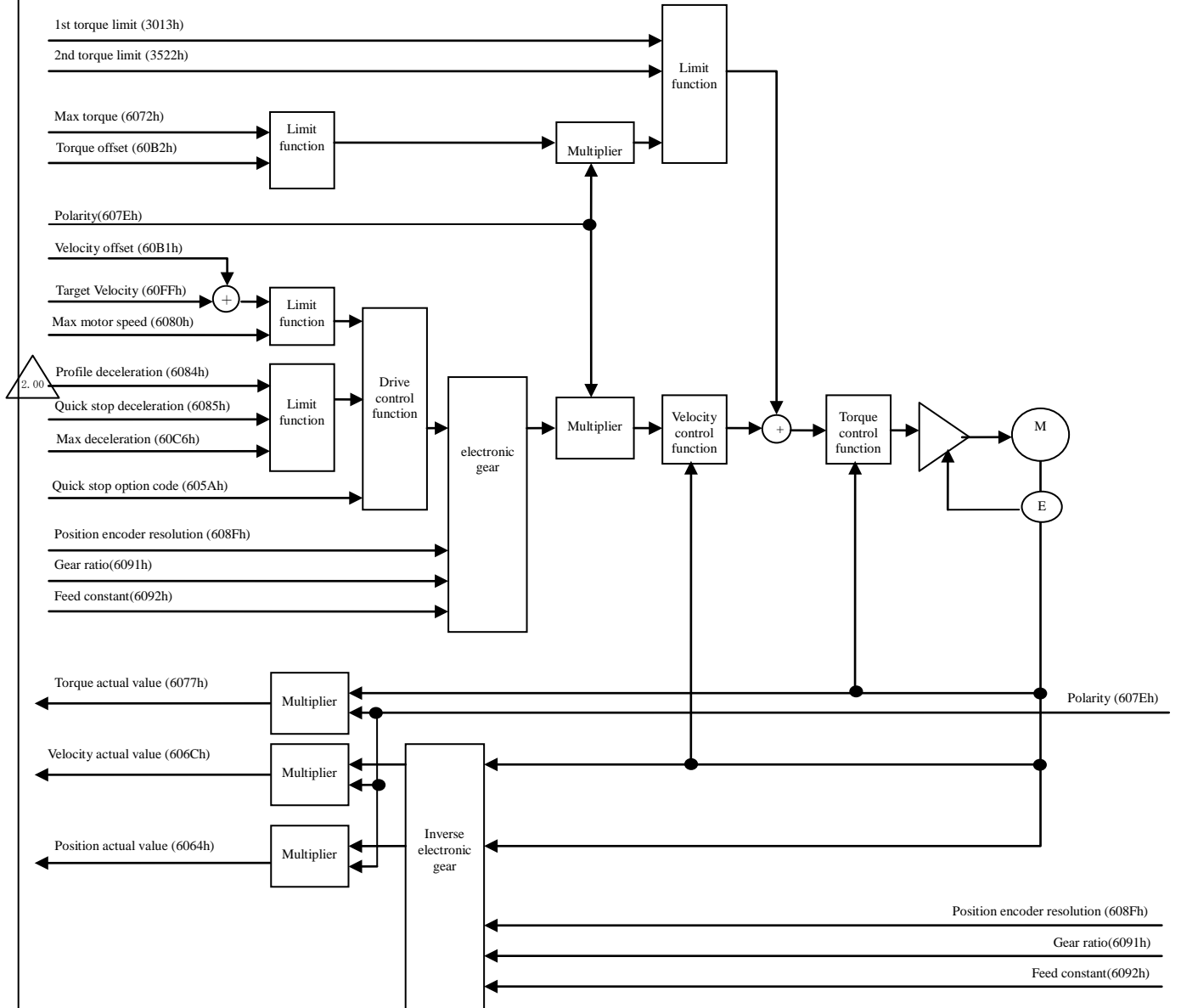

1) Objects related to csv mode (command & setup)

Index	Sub-Index	Name	Units	Range	Data Type	Access	PDO
6040h	00h	Controlword	-	0 - 65535	U16	rw	RxPDO
3724h	00h	Communication function extended setup 3	-	-32768 - 32767	I16	rw	No

- Besides, there are related objects common to the velocity control.

For more information, refer to the section 6-7-1.

Index	Sub-Index	Name	Units	Range	Data Type	Access	PDO
6072h	00h	Max torque	0.1%	0 - 65535	U16	rw	RxPDO
6080h	00h	Max motor speed	r/min	0 - 4294967295	U32	rw	RxPDO
60B1h	00h	Velocity offset	Command/s	-2147483648 - 2147483647	I32	rw	RxPDO
60B2h	00h	Torque offset	0.1%	-32768 - 32767	I16	rw	RxPDO
60FFh	00h	Target velocity	Command/s	-2147483648 - 2147483647	I32	rw	No

- There is a related object of common motion as well.

For more information, refer to the section 6-9.

Index	Sub-Index	Name	Units	Range	Data Type	Access	PDO
6007h	00h	Abort connection option code	-	0 - 3	I16	rw	No
605Ah	00h	Quick stop option code	-	0 - 7	I16	rw	No
605Bh	00h	Shutdown option code	-	0 - 1	I16	rw	No
605Ch	00h	Disable operation option code	-	0 - 1	I16	rw	No
605Dh	00h	Halt option code	-	1 - 3	I16	rw	No
605Eh	00h	Fault reaction option code	-	0 - 2	I16	rw	No
607Bh	-	Position range limit	-	-	-	-	-
	00h	Highest sub-index supported	-	2	U8	ro	No
	01h	Min position range limit	Command	-2147483648 - 2147483647	I32	rw	RxPDO
	02h	Max position range limit	Command	-2147483648 - 2147483647	I32	rw	RxPDO
607Ch	00h	Home offset	Command	-2147483648 - 2147483647	I32	rw	RxPDO
607Eh	00h	Polarity	-	0 - 255	U8	rw	No
6085h	00h	Quick stop deceleration	Command/s ²	0 - 4294967295	U32	rw	RxPDO
608Fh	-	Position encoder resolution	-	-	-	-	-
	00h	Highest sub-index supported	-	2	U8	ro	No
	01h	Encoder increments	pulse	1 - 4294967295	U32	ro	No
	02h	Motor revolutions	r (motor)	1 - 4294967295	U32	ro	No
6091h	-	Gear ratio	-	-	-	-	-
	00h	Number of entries	-	2	U8	ro	No
	01h	Motor revolutions	r (motor)	1 - 4294967295	U32	rw	No
	02h	Shaft revolutions	r (shaft)	1 - 4294967295	U32	rw	No
6092h	-	Feed constant	-	-	-	-	-
	00h	Highest sub-index supported	-	2	U8	ro	No
	01h	Feed	Command	1 - 4294967295	U32	rw	No
	02h	Shaft revolutions	r (shaft)	1 - 4294967295	U32	rw	No
60B8h	00h	Touch probe function	-	0 - 65535	U16	rw	RxPDO
60C2h	-	Interpolation time period	-	-	-	-	-
	00h	Highest sub-index supported	-	2	U8	ro	No
	01h	Interpolation time period value	-	0 - 255	U8	rw	No
	02h	Interpolation time index	-	-128 - 63	I8	rw	No
60FEh	-	Digital outputs	-	-	-	-	-
	00h	Number of entries	-	2	U8	ro	No
	01h	Physical outputs	-	0 - 4294967295	U32	rw	RxPDO
	02h	Bit mask	-	0 - 4294967295	U32	rw	RxPDO

- Controlword (6040h) <Functions in csv mode>

Index	Sub-Index	Name / Description	Units	Range	Data Type	Access	PDO	Opmode	EEPROM																																			
6040h	00h	Controlword • Set a command to a servo amplifier including the PDS state transition. Bit information details	-	0 - 65535	U16	rw	RxPDO	ALL	No																																			
		<table border="1"> <thead> <tr> <th>15 - 10</th> <th>9</th> <th>8</th> <th>7</th> <th>6</th> <th>5</th> <th>4</th> <th>3</th> <th>2</th> <th>1</th> <th>0</th> </tr> </thead> <tbody> <tr> <td>r</td> <td>oms</td> <td>h</td> <td>fr</td> <td colspan="3">oms</td> <td>eo</td> <td>qs</td> <td>ev</td> <td>so</td> </tr> <tr> <td></td> <td>r</td> <td></td> <td></td> <td>r</td> <td>r</td> <td>r</td> <td></td> <td></td> <td></td> <td></td> </tr> </tbody> </table>	15 - 10	9	8	7	6	5	4	3	2	1	0	r	oms	h	fr	oms			eo	qs	ev	so		r			r	r	r													
15 - 10	9	8	7	6	5	4	3	2	1	0																																		
r	oms	h	fr	oms			eo	qs	ev	so																																		
	r			r	r	r																																						
		r =reserved (not supported), oms = operation mode specific (control mode dependent bit), h = halt			fr = fault reset eo = enable operation qs = quick stop ev = enable voltage so = switch on																																							

Note: The csv mode does not use the oms bit.



- Other

Index	Sub-Index	Name / Description	Units	Range	Data Type	Access	PDO	Op-mode	EEPROM
3724h	00h	Communication function extended setup 3 3724h bit11: The setting condition that 6041h bit12 (drive follows command value) will be 0 is changed. 0 : Limiting torque and speed limit (only cst) is included. 1 : Limiting torque and speed limit (only cst) is not included.	-	-32768 - 32767	I16	rw	No	ALL	Yes

2) Objects related to csv mode (monitoring)

Index	Sub-Index	Name	Units	Range	Data Type	Access	PDO
6041h	00h	Statusword	-	0 - 65535	U16	ro	TxPDO

- Besides, there are related objects common to the velocity control.

For more information, refer to section 6-7-1.

Index	Sub-Index	Name	Units	Range	Data Type	Access	PDO
6063h	00h	Position actual internal value	pulse	-2147483648 - 2147483647	I32	ro	TxPDO
6064h	00h	Position actual value	Command	-2147483648 - 2147483647	I32	ro	TxPDO
6069h	00h	Velocity sensor actual value	-	-2147483648 - 2147483647	I32	ro	TxPDO
606Bh	00h	Velocity demand value	Command/s	-2147483648 - 2147483647	I32	ro	TxPDO
606Ch	00h	Velocity actual value	Command/s	-2147483648 - 2147483647	I32	ro	TxPDO
6074h	00h	Torque demand	0.1%	-32768 - 32767	I16	ro	TxPDO
6076h	00h	Motor rated torque	mNm	0 - 4294967295	U32	ro	TxPDO
6077h	00h	Torque actual value	0.1%	-32768 - 32767	I16	ro	TxPDO

- There is a related object of common motion as well.

For more information, refer to section 6-9.

Index	Sub-Index	Name	Units	Range	Data Type	Access	PDO
603Fh	00h	Error code	-	0 - 65535	U16	ro	TxPDO
60B9h	00h	Touch probe status	-	0 - 65535	U16	ro	TxPDO
60BAh	00h	Touch probe pos1 pos value	Command	-2147483648 - 2147483647	I32	ro	TxPDO
60BBh	00h	Touch probe pos1 neg value	Command	-2147483648 - 2147483647	I32	ro	TxPDO
60BCh	00h	Touch probe pos2 pos value	Command	-2147483648 - 2147483647	I32	ro	TxPDO
60BDh	00h	Touch probe pos2 neg value	Command	-2147483648 - 2147483647	I32	ro	TxPDO
60FDh	00h	Digital inputs	-	0 - 4294967295	U32	ro	TxPDO

- Statusword (6041h) <Functions in csv mode>

Index	Sub-Index	Name / Description	Units	Range	Data Type	Access	PDO	Opmode	EEPROM																														
6041h	00h	Statusword • Displays the servo amplifier state.	-	0000h - FFFFh	U16	ro	TxPDO	ALL	No																														
Bit information details																																							
<table border="1" style="width:100%; text-align:center;"> <tr> <td>15-14</td> <td>13</td> <td>12</td> <td>11</td> <td>10</td> <td>9</td> <td>8</td> <td>7</td> <td>6</td> <td>5</td> <td>4</td> <td>3</td> <td>2</td> <td>1</td> <td>0</td> </tr> <tr> <td>r</td> <td>oms</td> <td>drive follows command value</td> <td>ila</td> <td>oms</td> <td>rm</td> <td>r</td> <td>w</td> <td>sod</td> <td>qs</td> <td>ve</td> <td>f</td> <td>oe</td> <td>so</td> <td>rtso</td> </tr> </table>										15-14	13	12	11	10	9	8	7	6	5	4	3	2	1	0	r	oms	drive follows command value	ila	oms	rm	r	w	sod	qs	ve	f	oe	so	rtso
15-14	13	12	11	10	9	8	7	6	5	4	3	2	1	0																									
r	oms	drive follows command value	ila	oms	rm	r	w	sod	qs	ve	f	oe	so	rtso																									
r = reserved(not supported)					w = warning																																		
oms = operation mode specific (control mode dependent bit)					sod = switch on disabled																																		
ila = internal limit active					qs = quick stop																																		
rm = remote					ve = voltage enabled																																		
r = reserved(not supported)					f = fault																																		
					oe = operation enabled																																		
					so = switched on																																		
					rtso = ready to switch on																																		

bit13,12,10(operation mode specific):

Bit	Name	Value	Definition
10	reserved	-	Not used
12	Drive follows command value	0	Operation is not performed according to the target velocity. *1)
		1	Operation is performed according to the target velocity. *1)
13	reserved	-	Not used

*1) “Operation is performed according to the target velocity” refers to cases where the following conditions are all satisfied:

- PDS state is Operation enabled
- While not in deceleration (Halt, POT/NOT, Quickstop, Shutdown, Disable operation and Fault)
- While not in Halt status
- POT not detected when a positive direction operation command is in process, or NOT not detected when a negative direction operation command is in process
- Torque limit has not occurred(Valid only when this condition 3724h-bit11 is 0)

Index	Sub-Index	Name / Description	Units	Range	Data Type	Access	PDO	Op-mode	EEPROM
3724h	00h	Communication function extended setup 3	—	-32768 - 32767	I16	rw	No	ALL	Yes
3724h bit11: The setting condition that 6041h bit12 (drive follows command value) will be 0 is changed. 0 : Limiting torque and speed limit (only cst) is included. 1 : Limiting torque and speed limit (only cst) is not included.									



3) Operations of csv mode

- Motion profile (trajectory) generation is done in the master rather than the slave in the cyclic velocity control mode.
- Target velocity is additional value of 60FFh(Target velocity) and 60B1h(Velocity offset).
- For the operation command update (transmission), do input when approx. 100 ms has elapsed after the servo ON(Operation enabled command). 
- 60C2h (Interpolation time period) indicates the cycle to update the two object for 60FFh(Target velocity) and 60B1h(Velocity offset). This value is set to the cycle which is the same as 1C32-02h(Cycle time).
- As monitoring information, to provide the 606Ch(Velocity actual value).

Note) - The sum of 60FFh (Target velocity) and 60B1h (Velocity offset) is limited by 6080h (Max motor speed).
However, a change that is made to the value of 6080h (Max motor speed) during operation will not be reflected in that operation.

6-8 Torque Control Function

6-8-1 Common Torque Control Function

1) Torque control block diagram

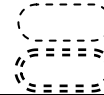
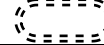
 Monitor data of PANATERM
 Monitor data of CiA402 object

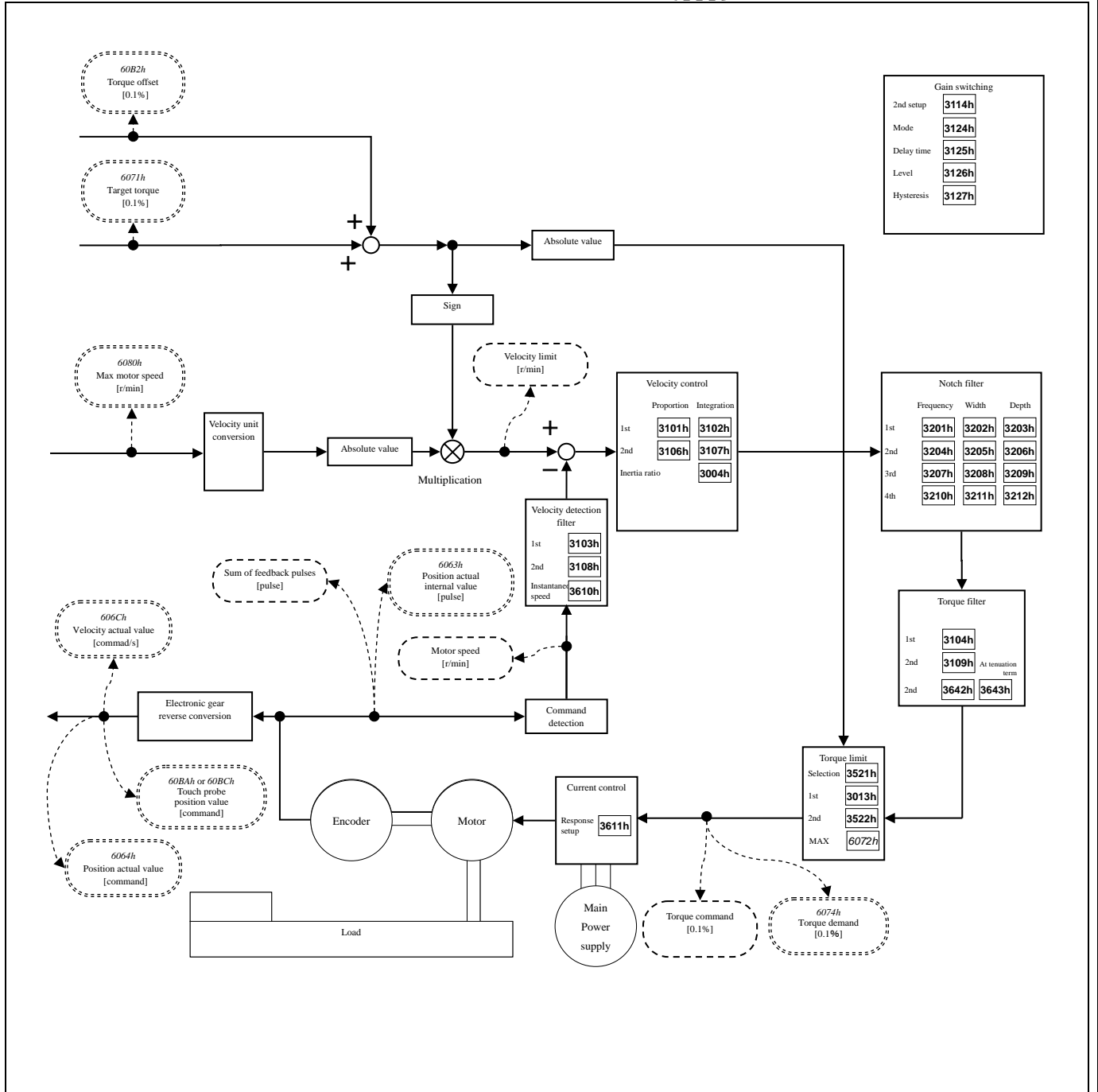

 2.00

Torque control block diagram

- *1) A slanting number (ex.:607Ah) shows the object number of EtherCAT.
- *2) A bold letter number (ex.:**3100h**) shows a parameter number.
- *3) Polarity was omitted.

2) Related objects common in torque control (command & setup)

Index	Sub-Index	Name	Units	Range	Data Type	Access	PDO	Supported mode	
								tq	cst
6040h	00h	Controlword	-	0 - 65535	U16	rw	RxPDO	Yes	Yes
6071h	00h	Target torque	0.1%	-32768 - 32767	I16	rw	RxPDO	Yes	Yes
6072h	00h	Max torque	0.1%	0 - 65535	U16	rw	RxPDO	Yes	Yes
6080h	00h	Max motor speed	r/min	0 - 4294967295	U32	rw	RxPDO	Yes	Yes
6087h	00h	Target slope	0.1%/s	0 - 4294967295	U32	rw	RxPDO	Yes	Yes
60B2h	00h	Torque offset	0.1%	-32768 - 32767	I16	rw	RxPDO	Yes	Yes

- Besides, there are related objects for each control mode.
Refer to the section "Related objects" of each control mode.
- The function of 6040h (Control word) can differ according to the control mode.
Refer to the section "Related objects" of each control mode.

- Velocity system

Index	Sub-Index	Name / Description	Units	Range	Data Type	Access	PDO	Opmode	EEPROM
6080h	00h	Max motor speed	r/min	0 - 4294967295	U32	rw	RxPDO	ALL	Yes
<ul style="list-style-type: none"> Set the maximum velocity of motor. The maximum value is limited by the maximum speed read out from the motor in internal processing. Tq and cst and restricts speed with the preset value of this object. 									

- Torque system

Index	Sub-Index	Name / Description	Units	Range	Data Type	Access	PDO	Opmode	EEPROM
6071h	00h	Target torque	0.1%	-32768 - 32767	I16	rw	RxPDO	tq cst	Yes
<ul style="list-style-type: none"> Set the torque command in the torque profile mode (tq) and cyclic synchronous torque mode (cst). When the value exceeds 6072h (Max torque), the value is limited by 6072h. 									
6072h	00h	Max torque	0.1%	0 - 65535	U16	rw	RxPDO	ALL	Yes
<ul style="list-style-type: none"> Set the maximum torque of the motor. The maximum value is limited by the maximum torque read out from the motor in internal processing. The maximum torque of the motor varies with the motor applied. 									
6087h	00h	Torque slope	0.1%/s	0 - 4294967295	U32	rw	RxPDO	tq cst	Yes
<ul style="list-style-type: none"> Set a parameter value for giving slope to a torque command. In the cyclic synchronous torque mode (cst), torque slope is effective only during the deceleration stop sequence. When 0 has been set, the setting is regarded as 1 internally. 									
60B2h	00h	Torque offset	0.1%	-32768 - 32767	I16	rw	RxPDO	csp csv cst	Yes
<ul style="list-style-type: none"> Set the offset of a torque command (torque feedforward). During slowdown in over-travel inhibition(in emergency stop), the torque feedforward level becomes 0. 									

- Other

Index	Sub-Index	Name / Description	Units	Range	Data Type	Access	PDO	Op-mode	EEPROM
3724h	00h	Communication function extended setup 3	—	-32768 - 32767	I16	rw	No	ALL	Yes
bit10 : Internal value state selection of objects 60B2h(Torque offset) in servo-off (Fall prevention function in the event of Servo-ON) 0: Clear 1: Updated with the set value of 60B2h									

3) Related objects common in torque control (monitoring)

Index	Sub-Index	Name	Units	Range	Data Type	Access	PDO	Supported mode	
								tq	cst
4D29h	00h	Over load factor	0.1%	0 - 65535	U16	ro	TxPDO	Yes	Yes
6041h	00h	Statusword	-	0 - 65535	U16	ro	TxPDO	Yes	Yes
6063h	00h	Position actual internal value	pulse	-2147483648 - 2147483647	I32	ro	TxPDO	Yes	Yes
6064h	00h	Position actual value	Command	-2147483648 - 2147483647	I32	ro	TxPDO	Yes	Yes
6069h	00h	Velocity sensor actual value	-	-2147483648 - 2147483647	I32	ro	TxPDO	Yes	Yes
606Ch	00h	Velocity actual value	Command/s	-2147483648 - 2147483647	I32	ro	TxPDO	Yes	Yes
6074h	00h	Torque demand	0.1%	-32768 - 32767	I16	ro	TxPDO	Yes	Yes
6075h	00h	Motor rated current	mA	0 - 4294967295	U32	ro	No	Yes	Yes
6076h	00h	Motor rated torque	mNm	0 - 4294967295	U32	ro	No	Yes	Yes
6077h	00h	Torque actual value	0.1%	-32768 - 32767	I16	ro	TxPDO	Yes	Yes
6078h	00h	Current actual value	0.1%	-32768 - 32767	I16	ro	TxPDO	Yes	Yes
6079h	00h	DC link circuit voltage	mV	0 - 4294967295	U32	ro	TxPDO	Yes	Yes

- Besides, there are related objects for each control mode.
Refer to the section "Related objects" of each control mode.
- The function of 6041h (Status word) can differ according to each control mode.
Refer to the section "Related objects" of each control mode.

- Position system

Index	Sub-Index	Name / Description	Units	Range	Data Type	Access	PDO	Opmode	EEPROM
6063h	00h	Position actual internal value <ul style="list-style-type: none"> Displays the actual position of the motor. The value is on an encoder basis during other than full-closed control, and on an external scale basis during full-closed control. 	pulse	-2147483648 - 2147483647	I32	ro	TxPDO	ALL	No
6064h	00h	Position actual value <ul style="list-style-type: none"> Indicate the motor of actual position. 	Command	-2147483648 - 2147483647	I32	ro	TxPDO	ALL	No

- Velocity system

Index	Sub-Index	Name / Description	Units	Range	Data Type	Access	PDO	Opmode	EEPROM
6069h	00h	Velocity sensor actual value <ul style="list-style-type: none"> Indicate sensor value of actual velocity. Return 0 always because this servo amplifier not supported. 	—	-2147483648 - 2147483647	I32	ro	TxPDO	ALL	No
606Ch	00h	Velocity actual value <ul style="list-style-type: none"> Displays the actual velocity of the motor. 	Command/s	-2147483648 - 2147483647	I32	ro	TxPDO	ALL	No

- Torque system

Index	Sub-Index	Name / Description	Units	Range	Data Type	Access	PDO	Opmode	EEPROM
4.00 4D29h	00h	Over load factor <ul style="list-style-type: none"> The ratio [0.1%] to the rated load is displayed. 	0.1%	0 - 65536	U16	ro	TxPDO	ALL	No
6074h	00h	Torque demand <ul style="list-style-type: none"> Displays internal command torque. 	0.1%	-32768 - 32767	I16	ro	TxPDO	ALL	No
6075h	00h	Motor rated current <ul style="list-style-type: none"> Automatically set the rated current of motor. 	mA	0 - 4294967295	U32	ro	No	ALL	No
6076h	00h	Motor rated torque <ul style="list-style-type: none"> Automatically set the rated torque of motor. 	mNm	0 - 4294967295	U32	ro	No	ALL	No
6077h	00h	Torque actual value <ul style="list-style-type: none"> Displays the actual torque. It becomes a value equivalent to actual current value. This output value is a reference value and does not guarantee an actual value. 	0.1%	-32768 - 32767	I16	ro	TxPDO	ALL	No
6078h	00h	Current actual value <ul style="list-style-type: none"> Displays actual current value. 	0.1%	-32768 - 32767	I16	ro	TxPDO	ALL	No
6079h	00h	DC link circuit voltage <ul style="list-style-type: none"> Displays the PN voltage in the main circuit power. 	mV	0 - 4294967295	U32	ro	TxPDO	ALL	No

6-8-2 Profile Torque Mode (tq mode)

It is a torque control mode to operate by designating the target torque, addition-subtraction velocity, etc. and creating a position command in the servo amplifier.

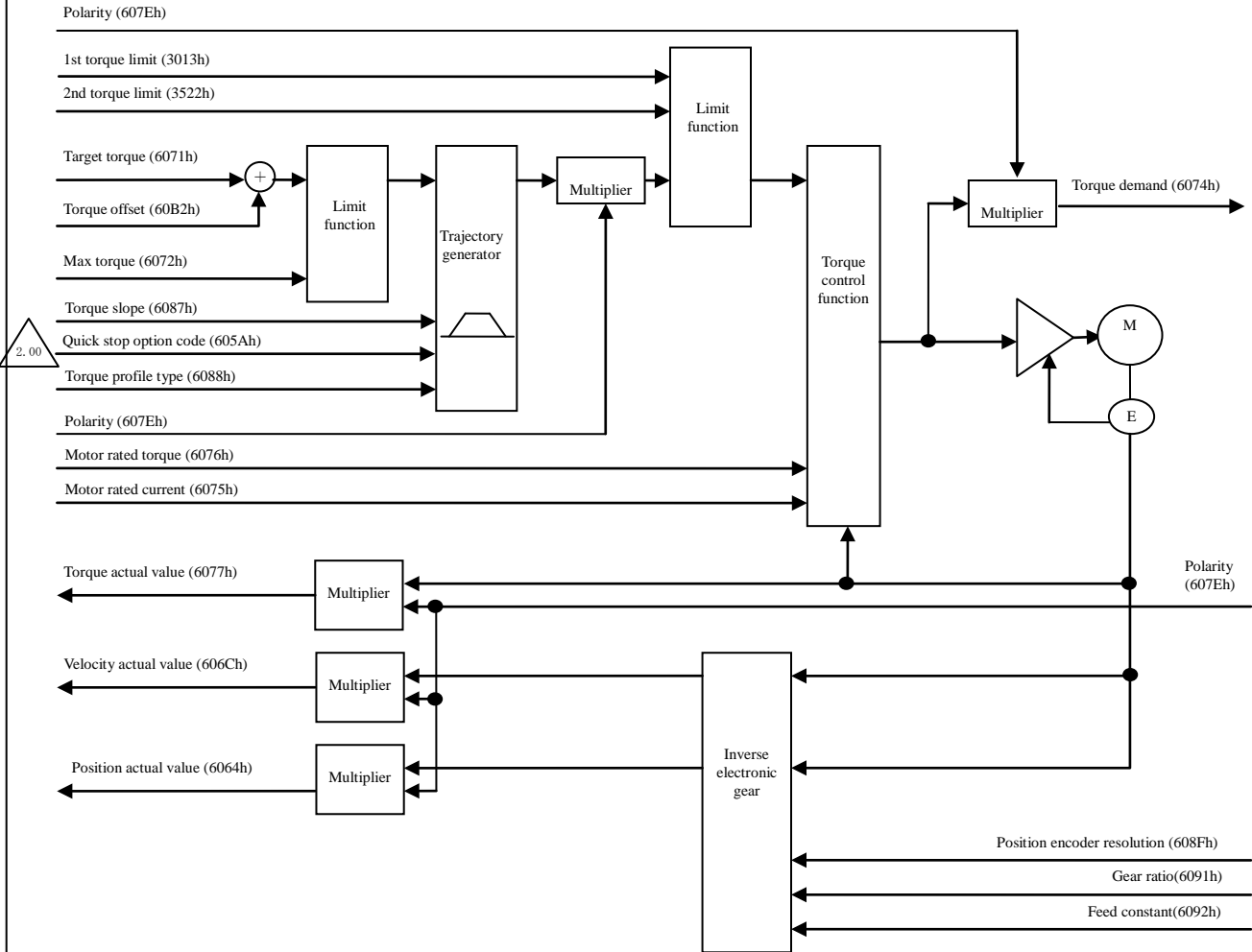

1) Objects related to tq mode (command & setup)

Index	Sub-Index	Name	Units	Range	Data Type	Access	PDO
6040h	00h	Controlword	-	0 - 65535	U16	rw	RxPDO
6088h	00h	Torque profile type	-	-32768 - 32767	I16	rw	RxPDO







- Besides, there are related objects common to the torque control.

For more information, refer to section 6-8-1.

Index	Sub-Index	Name	Units	Range	Data Type	Access	PDO
6071h	00h	Target torque	0.1%	-32768 - 32767	I16	rw	RxPDO
6072h	00h	Max torque	0.1%	0 - 65535	U16	rw	RxPDO
6080h	00h	Max motor speed	r/min	0 - 4294967295	U32	rw	RxPDO
6087h	00h	Target slope	0.1%/s	0 - 4294967295	U32	rw	RxPDO
60B2h	00h	Torque offset	0.1%	-32768 - 32767	I16	rw	RxPDO

- There is a related object of common motion as well.

For more information, refer to section 6-9.

Index	Sub-Index	Name	Units	Range	Data Type	Access	PDO
6007h	00h	Abort connection option code	-	0 - 3	I16	rw	No
605Ah	00h	Quick stop option code	-	0 - 7	I16	rw	No
605Bh	00h	Shutdown option code	-	0 - 1	I16	rw	No
605Ch	00h	Disable operation option code	-	0 - 1	I16	rw	No
605Dh	00h	Halt option code	-	1 - 3	I16	rw	No
605Eh	00h	Fault reaction option code	-	0 - 2	I16	rw	No
607Bh	-	Position range limit	-	-	-	-	-
	00h	Highest sub-index supported	-	2	U8	ro	No
	01h	Min position range limit	Command	-2147483648 – 2147483647	I32	rw	RxPDO
	02h	Max position range limit	Command	-2147483648 – 2147483647	I32	rw	RxPDO
607Ch	00h	Home offset	Command	-2147483648 – 2147483647	I32	rw	RxPDO
607Eh	00h	Polarity	-	0 – 255	U8	rw	No
608Fh	-	Position encoder resolution	-	-	-	-	-
	00h	Highest sub-index supported	-	2	U8	ro	No
	01h	Encoder increments	pulse	 1 – 4294967295	U32	ro	No
	02h	Motor revolutions	r (motor)	 1 – 4294967295	U32	ro	No
6091h	-	Gear ratio	-	-	-	-	-
	00h	Number of entries	-	2	U8	ro	No
	01h	Motor revolutions	r (motor)	 1 – 4294967295	U32	rw	No
	02h	Shaft revolutions	r (shaft)	 1 – 4294967295	U32	rw	No
6092h	-	Feed constant	-	-	-	-	-
	00h	Highest sub-index supported	-	2	U8	ro	No
	01h	Feed	Command	 1 – 4294967295	U32	rw	No
	02h	Shaft revolutions	r (shaft)	 1 – 4294967295	U32	rw	No
60B8h	00h	Touch probe function	-	0 - 65535	U16	rw	RxPDO
60FEh	-	Digital outputs	-	-	-	-	-
	00h	Number of entries	-	2	U8	ro	No
	01h	Physical outputs	-	0 - 4294967295	U32	rw	RxPDO
	02h	Bit mask	-	0 - 4294967295	U32	rw	RxPDO

- Controlword (6040h) <Functions in tq mode>

Index	Sub-Index	Name / Description	Units	Range	Data Type	Access	PDO	Opmode	EEPROM		
6040h	00h	Controlword • Set a command to a servo amplifier including the PDS state transition.	-	0 - 65535	U16	rw	RxPDO	ALL	No		
Bit information details											
15 - 10		9	8	7	6	5	4	3	2	1	0
r		oms	h	fr	oms			eo	qs	ev	so
r		r			r	r	r				
r	= reserved (not supported)			fr	= fault reset						
oms	= operation mode specific (control mode dependent bit)			eo	= enable operation						
h	= halt			qs	= quick stop						
				ev	= enable voltage						
				so	= switch on						

* Note: The tq mode does not use the oms bit.

- Torque system

Index	Sub-Index	Name / Description	Units	Range	Data Type	Access	PDO	Op-mode	EEPROM
6087h	00h	Torque slope <ul style="list-style-type: none"> Set a parameter value for giving slope to a torque command. In the cyclic synchronous torque mode (cst), torque slope is effective only during the deceleration stop sequence. When 0 has been set, the setting is regarded as 1 internally. 	0.1%/s	0 - 4294967295	U32	Rw	RxPDO	tq cst	Yes
6088h	00h	Torque profile type <ul style="list-style-type: none"> Set the torque profile type used for changing the torque. <p>0: Linear slope 1: Not supported (sin² slope)</p>	-	-32768 - 32767	I16	rw	RxPDO	tq	Yes

2) Related objects (monitoring)

Index	Sub-Index	Name	Units	Range	Data Type	Access	PDO
6041h	00h	Statusword	-	0 - 65535	U16	ro	TxPDO
6073h	00h	Max current	0.1%	0 - 65535	U16	ro	No

- Besides, there are related objects common to the torque control.

For more information, refer to section 6-8-1.

Index	Sub-Index	Name	Units	Range	Data Type	Access	PDO
6063h	00h	Position actual internal value	pulse	-2147483648 - 2147483647	I32	ro	TxPDO
6064h	00h	Position actual value	Command	-2147483648 - 2147483647	I32	ro	TxPDO
6069h	00h	Velocity sensor actual value	-	-2147483648 - 2147483647	I32	ro	TxPDO
606Ch	00h	Velocity actual value	Command/s	-2147483648 - 2147483647	I32	ro	TxPDO
6074h	00h	Torque demand	0.1%	-32768 - 32767	I16	ro	TxPDO
6075h	00h	Motor rated current	mA	0 - 4294967295	U32	ro	No
6076h	00h	Motor rated torque	mNm	0 - 4294967295	U32	ro	No
6077h	00h	Torque actual value	0.1%	-32768 - 32767	I16	ro	TxPDO
6078h	00h	Current actual value	0.1%	-32768 - 32767	I16	ro	TxPDO
6079h	00h	DC link circuit voltage	mV	0 - 4294967295	U32	ro	TxPDO

- There is a related object of common motion as well.

For more information, refer to section 6-9.

Index	Sub-Index	Name	Units	Range	Data Type	Access	PDO
603Fh	00h	Error code	-	0 - 65535	U16	ro	TxPDO
60B9h	00h	Touch probe status	-	0 - 65535	U16	ro	TxPDO
60BAh	00h	Touch probe pos1 pos value	Command	-2147483648 - 2147483647	I32	ro	TxPDO
60BBh	00h	Touch probe pos1 neg value	Command	-2147483648 - 2147483647	I32	ro	TxPDO
60BCh	00h	Touch probe pos2 pos value	Command	-2147483648 - 2147483647	I32	ro	TxPDO
60BDh	00h	Touch probe pos2 neg value	Command	-2147483648 - 2147483647	I32	ro	TxPDO
60FDh	00h	Digital inputs	-	0 - 4294967295	U32	ro	TxPDO

- Statusword (6041h) <Functions in tq mode>

Index	Sub-Index	Name / Description	Units	Range	Data Type	Access	PDO	Opmode	EEPROM																																		
6041h	00h	Statusword • Displays the servo amplifier state. Bit information details	-	0 - 65535	U16	ro	TxPDO	ALL	No																																		
		<table border="1"> <thead> <tr> <th>15 - 14</th> <th>13</th> <th>12</th> <th>11</th> <th>10</th> <th>9</th> <th>8</th> <th>7</th> <th>6</th> <th>5</th> <th>4</th> <th>3</th> <th>2</th> <th>1</th> <th>0</th> </tr> </thead> <tbody> <tr> <td colspan="2">r</td> <td colspan="2">oms</td> <td colspan="2">ila</td> <td colspan="2">target reached</td> <td>rm</td> <td>r</td> <td>w</td> <td>sod</td> <td>qs</td> <td>ve</td> <td>f</td> <td>oe</td> <td>so</td> <td>rtso</td> </tr> </tbody> </table>	15 - 14	13	12	11	10	9	8	7	6	5	4	3	2	1	0	r		oms		ila		target reached		rm	r	w	sod	qs	ve	f	oe	so	rtso								
15 - 14	13	12	11	10	9	8	7	6	5	4	3	2	1	0																													
r		oms		ila		target reached		rm	r	w	sod	qs	ve	f	oe	so	rtso																										
		r = reserved(not supported) oms = operation mode specific (control mode dependent bit) ila = internal limit active rm = remote																																									
		w = warning sod = switch on disabled qs = quick stop ve = voltage enabled f = fault oe = operation enabled so = switched on rtso = ready to switch on																																									

oms bit details (tq)

Bit	Name	Value	Definition
10	target reached	0	halt=0 (during normal operation) : 6074h (Torque demand) has not yet reached target torque. halt=1 (during stop by halt) : During axis deceleration
		1	halt=0 (during normal operation) : 6074h (Torque demand) has reached target torque. halt=1 (during stop by halt) : Axis stop (Axis speed is 0.)
12	(reserved)	-	Not used
13	(reserved)	-	Not used

- Torque system

Index	Sub-Index	Name / Description	Units	Range	Data Type	Access	PDO	Op-mode	EEPROM
6073h	00h	Max current • Set the maximum current.	0.1%	0 - 65535	U16	rw	No	tq	Yes

3) Operations of tq mode

Profile torque control mode generates a torque command value according to the following parameters.

- Target torque(6071h)
- Torque slope(6087h)

Target torque is additional value of 6071h(Target torque) and 60B2h(Torque offset).

For the operation command update (transmission), do input when approx. 100 ms has elapsed after the servo ON(Operation enabled command).



As monitoring information to provide 6077h (Torque actual value).

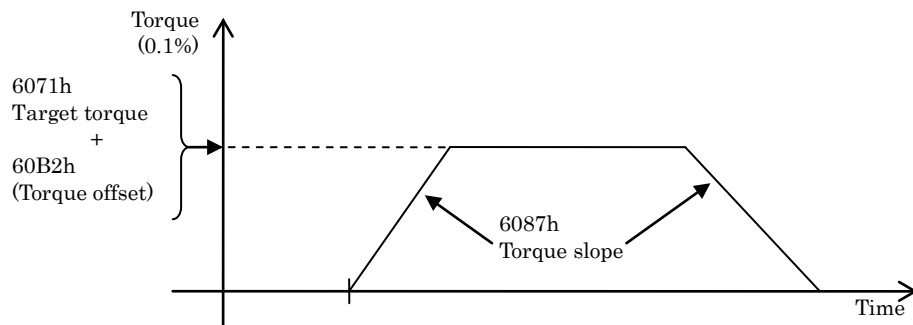

- Note)
- The sum of 6071h (Target torque) and 60B2h (Torque offset) is limited by the lowest value among 6072h (Max torque), and 3013h (1st torque limit).
 - The velocity is limited by 6080h (Max motor speed).
 - Even if these setting values are changed during operation, they are not reflected during the operation.

6-8-3 Cyclic Torque Mode (cst mode)

It is a torque control mode to operate by creating a command torque in the upper system (master) and updating (transmitting) the command torque in an interpolation cycle.
Use it in the DC or SM2 synchronization mode.

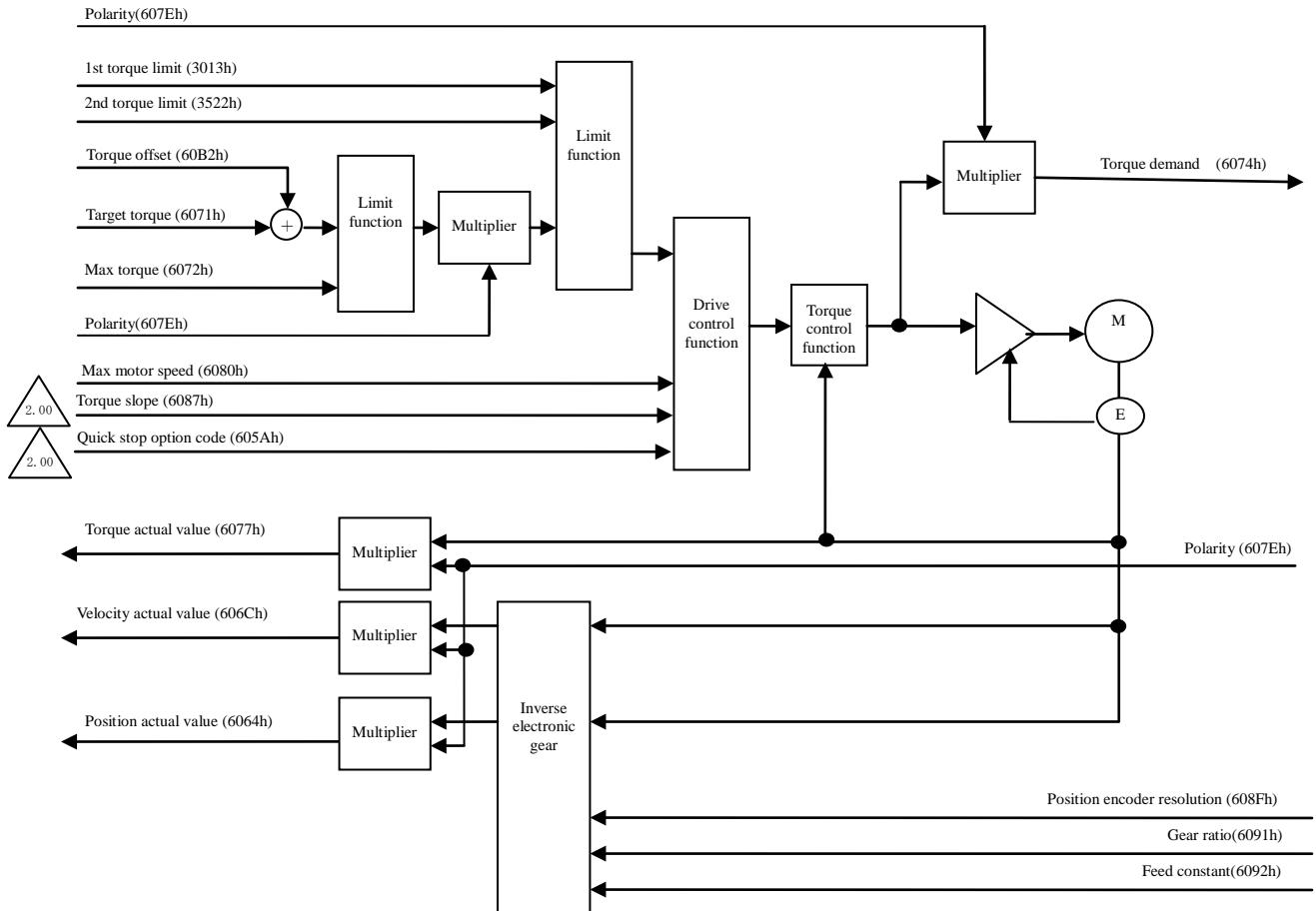

1) Objects related to cst mode (command & setup)

Index	Sub-Index	Name	Units	Range	Data Type	Access	PDO
6040h	00h	Controlword	-	0 - 65535	U16	rw	Yes
3724h	00h	Communication function extended setup 3	-	-32768 - 32767	I16	rw	No

- Besides, there are related objects common to the torque control.

For more information, refer to section 6-8-1.

Index	Sub-Index	Name	Units	Range	Data Type	Access	PDO
6071h	00h	Target torque	0.1%	-32768 - 32767	I16	rw	RxPDO
6072h	00h	Max torque	0.1%	0 - 65535	U16	rw	RxPDO
6080h	00h	Max motor speed	r/min	0 - 4294967295	U32	rw	RxPDO
6087h	00h	Target slope	0.1%/s	0 - 4294967295	U32	rw	RxPDO
60B2h	00h	Torque offset	0.1%	-32768 - 32767	I16	rw	RxPDO

- There is a related object of common motion as well.

For more information, refer to section 6-9.

Index	Sub-Index	Name	Units	Range	Data Type	Access	PDO
6007h	00h	Abort connection option code	-	0 - 3	I16	rw	No
605Ah	00h	Quick stop option code	-	0 - 7	I16	rw	No
605Bh	00h	Shutdown option code	-	0 - 1	I16	rw	No
605Ch	00h	Disable operation option code	-	0 - 1	I16	rw	No
605Dh	00h	Halt option code	-	1 - 3	I16	rw	No
605Eh	00h	Fault reaction option code	-	0 - 2	I16	rw	No
607Bh	-	Position range limit	-	-	-	-	-
	00h	Highest sub-index supported	-	2	U8	ro	No
	01h	Min position range limit	Command	-2147483648 - 2147483647	I32	rw	RxPDO
	02h	Max position range limit	Command	-2147483648 - 2147483647	I32	rw	RxPDO
607Ch	00h	Home offset	Command	-2147483648 - 2147483647	I32	rw	RxPDO
607Eh	00h	Polarity	-	0 - 255	U8	rw	No
608Fh	-	Position encoder resolution	-	-	-	-	-
	00h	Highest sub-index supported	-	2	U8	ro	No
	01h	Encoder increments	pulse	1 - 4294967295	U32	ro	No
	02h	Motor revolutions	r (motor)	1 - 4294967295	U32	ro	No
6091h	-	Gear ratio	-	-	-	-	-
	00h	Number of entries	-	2	U8	ro	No
	01h	Motor revolutions	r (motor)	1 - 4294967295	U32	rw	No
	02h	Shaft revolutions	r (shaft)	1 - 4294967295	U32	rw	No
6092h	-	Feed constant	-	-	-	-	-
	00h	Highest sub-index supported	-	2	U8	ro	No
	01h	Feed	Command	1 - 4294967295	U32	rw	No
	02h	Shaft revolutions	r (shaft)	1 - 4294967295	U32	rw	No
60B8h	00h	Touch probe function	-	0 - 65535	U16	rw	Yes
60C2h	-	Interpolation time period	-	-	-	-	-
	00h	Highest sub-index supported	-	2	U8	ro	No
	01h	Interpolation time period value	-	0 - 255	U8	rw	No
	02h	Interpolation time index	-	-128 - 63	I8	rw	No
60FEh	-	Digital outputs	-	-	-	-	-
	00h	Number of entries	-	2	U8	ro	No
	01h	Physical outputs	-	0 - 4294967295	U32	rw	RxPDO
	02h	Bit mask	-	0 - 4294967295	U32	rw	RxPDO

- Controlword (6040h) <Functions in cst mode>

Index	Sub-Index	Name / Description	Units	Range	Data Type	Access	PDO	Opmode	EEPROM																																			
6040h	00h	Controlword • Set a command to a servo amplifier including the PDS state transition. Bit information details	-	0 - 65535	U16	rw	RxPDO	ALL	No																																			
		<table border="1"> <thead> <tr> <th>15 - 10</th> <th>9</th> <th>8</th> <th>7</th> <th>6</th> <th>5</th> <th>4</th> <th>3</th> <th>2</th> <th>1</th> <th>0</th> </tr> </thead> <tbody> <tr> <td>r</td> <td>oms</td> <td>h</td> <td>fr</td> <td colspan="3">oms</td> <td>eo</td> <td>qs</td> <td>ev</td> <td>so</td> </tr> <tr> <td></td> <td>r</td> <td></td> <td></td> <td>r</td> <td>r</td> <td>r</td> <td></td> <td></td> <td></td> <td></td> </tr> </tbody> </table>	15 - 10	9	8	7	6	5	4	3	2	1	0	r	oms	h	fr	oms			eo	qs	ev	so		r			r	r	r													
15 - 10	9	8	7	6	5	4	3	2	1	0																																		
r	oms	h	fr	oms			eo	qs	ev	so																																		
	r			r	r	r																																						
		r = reserved (Not supported) fr = fault reset oms = operation mode specific eo = enable operation (control mode dependent bit) qs = quick stop h = halt ev = enable voltage so = switch on																																										

*Note: The cst mode does not use the oms bit.



- Other

Index	Sub-Index	Name / Description	Units	Range	Data Type	Access	PDO	Op-mode	EEPROM
3724h	00h	Communication function extended setup 3 3724h bit11: The setting condition that 6041h bit12 (drive follows command value) will be 0 is changed. 0 : Limiting torque and speed limit (only cst) is included. 1 : Limiting torque and speed limit (only cst) is not included.	—	-32768 - 32767	I16	rw	No	ALL	Yes

2) Objects related to cst mode (monitoring)

Index	Sub-Index	Name	Units	Range	Data Type	Access	PDO
6041h	00h	Statusword	-	0 - 65535	U16	ro	TxPDO
6064h	00h	Position actual value	Command	-2147483648 - 2147483647	I32	ro	TxPDO
606Ch	00h	Velocity actual value	Command/s	-2147483648 - 2147483647	I32	ro	TxPDO

- Besides, there are related objects common to the torque control.

For more information, refer to section 6-8-1.

Index	Sub-Index	Name	Units	Range	Data Type	Access	PDO
6063h	00h	Position actual internal value	pulse	-2147483648 - 2147483647	I32	ro	TxPDO
6064h	00h	Position actual value	Command	-2147483648 - 2147483647	I32	ro	TxPDO
606Ch	00h	Velocity actual value	Command/s	-2147483648 - 2147483647	I32	ro	TxPDO
6074h	00h	Torque demand	0.1%	-32768 - 32767	I16	ro	TxPDO
6075h	00h	Motor rated current	mA	0 - 4294967295	U32	ro	No
6076h	00h	Motor rated torque	mN·m	0 - 4294967295	U32	ro	No
6077h	00h	Torque actual value	0.1%	-32768 - 32767	I16	ro	TxPDO
6078h	00h	Current actual value	0.1%	-32768 - 32767	I16	ro	TxPDO
6079h	00h	DC link circuit voltage	mV	0 - 4294967295	U32	ro	TxPDO

- There is a related object of common motion as well.

For more information, refer to section 6-9.

Index	Sub-Index	Name	Units	Range	Data Type	Access	PDO
603Fh	00h	Error code	-	0 - 65535	U16	ro	TxPDO
60B9h	00h	Touch probe status	-	0 - 65535	U16	ro	TxPDO
60BAh	00h	Touch probe pos1 pos value	Command	-2147483648 - 2147483647	I32	ro	TxPDO
60BBh	00h	Touch probe pos1 neg value	Command	-2147483648 - 2147483647	I32	ro	TxPDO
60BCh	00h	Touch probe pos2 pos value	Command	-2147483648 - 2147483647	I32	ro	TxPDO
60BDh	00h	Touch probe pos2 neg value	Command	-2147483648 - 2147483647	I32	ro	TxPDO
60FDh	00h	Digital inputs	-	0 - 4294967295	U32	ro	TxPDO

3) Operations of cst mode

- Motion profile (trajectory) generation is done by the master, not the slave in cyclic torque control mode.
- Target torque is additional value of 6071h(Target torque) and 60B2h(Torque offset).
- For the operation command update (transmission), do input when approx. 100 ms has elapsed after the servo ON(Operation enabled command). 
- 60C2h (Interpolation time period) indicates the cycle to update the two object for 6071h (Target torque) and 60B2h (Torque offset). This value is set to the cycle which is the same as 1C32-02h(Cycle time).
- As monitoring information to provide 6077h (Torque actual value).

- Note) - The sum of 6071h (Target torque) and 60B2h (Torque offset) is limited by the minimum value of either 6072h (Max torque) or 3013h (1st torque limit).
- The velocity is limited by 6080h (Max motor speed).

6-9 Common Motion Function

6-9-1 Touch Probe Function (position latch request/release)

This function selects a latch trigger signal from external input (EXT 1/EXT 2) or Z-phase (one rotation data of rotary encoder is 0 position during semi-closed control, and Z-phase position of external incremental scale during full-closed control) and latches the feedback position.

- When it uses a external input (EXT1/EXT2) by the signal of latch trigger, assign EXT1 to SI5 and assign EXT2 to SI6, respectively.
When Homing operation is carried out without assigning, Err88.5 (Latch input allocation error protection) occurs.
 - If the latch trigger signal is external input(EXT1/EXT2), the import difference occurs.
Reduce the velocity around the latch trigger signal input as much as possible.
 - Set the input ON width and OFF width of the latch trigger signal to 2 ms or more.
 - If the Z-phase is selected by the trigger while using absolute scale during full-closed control, Err88.5 (Latch input allocation error protection) occurs.
 - If the setting chooses the Z-phase selection at the trigger, please do not select edge falling.
The operation can not be guaranteed if it set to the above setting.
 - The touch probe function is disabled in the cases below:
 - 1) The ESM state becomes Init
 - 2) The mode changed into the hm mode
 - Please do not set at the same time the rising and falling edges of the same TouchProbe.
Behavior when set at the same time can not be guaranteed.
-  Do not execute Touch probe 1 and Touch probe 1 and Touch probe 2 simultaneously at 250us of communication interval of in the mode of 2 degrees of freedom control.
Behavior when Touch probe 1 and Touch probe 2 are simultaneously executed with the above setting cannot be guaranteed.

1) Configuration of touch probe function

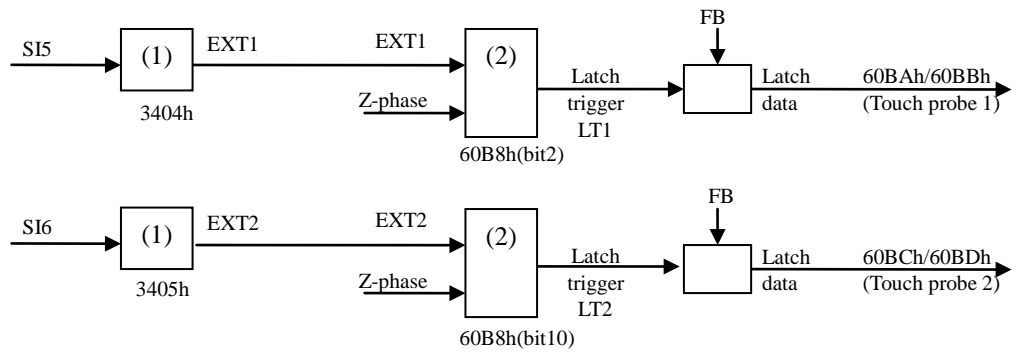

60B8h : Touch probe function
 60BAh : Touch probe pos1 pos value
 60BBh : Touch probe pos1 neg value
 60BCh : Touch probe pos2 pos value
 60BDh : Touch probe pos2 neg value

(1) Allocating general-purpose input			
Signal	Parameter	Allocation	Setup value
SI5	3404h	Selects EXT 1	00202020h
SI6	3405h	Selects EXT 2	00212121h

(2) 60B8h (Touch probe function)			
Bit10	LT2	Bit2	LT1
0	EXT2	0	EXT1
1	Z-phase	1	Z-phase

2) Touch probe relevant object

Index	Sub-Index	Name	Units	Range	Data Type	Access	PDO
60B8h	00h	Touch probe function	-	0 - 65535	U16	rw	RxPDO
60B9h	00h	Touch probe status	-	0 - 65535	U16	ro	TxPDO
60BAh	00h	Touch probe pos1 pos value	Command	-2147483648 - 2147483647	I32	ro	TxPDO
60BBh	00h	Touch probe pos1 neg value	Command	-2147483648 - 2147483647	I32	ro	TxPDO
60BCh	00h	Touch probe pos2 pos value	Command	-2147483648 - 2147483647	I32	ro	TxPDO
60BDh	00h	Touch probe pos2 neg value	Command	-2147483648 - 2147483647	I32	ro	TxPDO

3) Touch probe function (60B8h)

The basic object used for starting touch probe operation and configuring various setting.

Index	Sub-Index	Name / Description	Units	Range	Data Type	Access	PDO	Opmode	EEPROM
60B8h	00h	Touch probe function • Set the Touch probe function.	-	0 - 65535	U16	rw	RxPDO	ALL	No

Bit description

bit	value	Note	
0	0	Switch off touch probe 1	Touch Probe 1 Start/stop
	1	Enable touch probe 1	
1	0	Trigger first event	Touch Probe 1 Select event mode
	1	Continuous	
2	0	Trigger with touch probe 1 input	Touch Probe 1 Select trigger (external input/Z-phase)
	1	Trigger with 0 impulse signal of position encoder	
3	-	Reserved	Not used
4	0	Switch off sampling at positive edge of touch probe 1	Touch Probe 1 Select rising edge
	1	Enable sampling at positive edge of touch probe 1	
5	0	Switch off sampling at negative edge of touch probe 1	Touch Probe 1 Select falling edge
	1	Enable sampling at negative edge of touch probe 1	
6-7	-	Not Supported	Not used

bit	value	Note	
8	0	Switch off touch probe 2	Touch Probe 2 Start/stop
	1	Enable touch probe 2	
9	0	Trigger first event	Touch Probe 2 Select event mode (single/continuous)
	1	Continuous	
10	0	Trigger with touch probe 2 input	Touch Probe 2 Select trigger (external input/Z-phase)
	1	Trigger with 0 impulse signal of position encoder	
11	-	Reserved	Not used
12	0	Switch off sampling at positive edge of touch probe 2	Touch Probe 2 Select rising edge
	1	Enable sampling at positive edge of touch probe 2	
13	0	Switch off sampling at negative edge of touch probe 2	Touch Probe 2 Select falling edge
	1	Enable sampling at negative edge of touch probe 2	
14-15	-	Not Supported	Not used

- Please do not set at the same time the rising and falling edges of the same TouchProbe. Behavior when set at the same time can not be guaranteed.
- When choose the Z-phase selection at the trigger, please do not select edge falling. The action at the time of performing the above-mentioned setup cannot be guaranteed.
- Indicates that the logical state changes from OFF to ON and the rising edge of the signal of interest. Also, indicate the timing of changes from ON to OFF logic state of the signal of interest is falling edge.

4) Touch probe status (60B9h)

Displays the state of the touch probe operation.

Index	Sub-Index	Name / Description	Units	Range	Data Type	Access	PDO	Opmode	EEPROM
60B9h	00h	Touch probe status • Displays the state of the Touch probe function.	-	0 - 65535	U16	ro	TxPDO	ALL	No

Bit description

bit	value	Note	
0	0	Touch probe 1 is switch off	Touch probe 1 operation stop
	1	Touch probe 1 is enabled	Touch probe 1 is in operation
1	0	Touch probe 1 no positive edge value stored	Rising edge Touch probe 1 is incomplete status
	1	Touch probe 1 positive edge value stored	Rising edge Touch probe 1 is completion status
2	0	Touch probe 1 no negative edge value stored	Falling edge Touch probe 1 is incomplete status
	1	Touch probe 1 negative edge value stored	Falling edge Touch probe 1 is completion status
3-5	-	Reserved	Not used
6-7	-	Not Supported	Not used

bit	value	Note	
8	0	Touch probe 2 is switch off	Touch probe 2 operation stop
	1	Touch probe 2 is enabled	Touch probe 2 is in operation
9	0	Touch probe 2 no positive edge value stored	Rising edge Touch probe 2 is incomplete status
	1	Touch probe 2 positive edge value stored	Rising edge Touch probe 2 is completion status
10	0	Touch probe 2 no negative edge value stored	Falling edge Touch probe 2 is incomplete status
	1	Touch probe 2 negative edge value stored	Falling edge Touch probe 2 is completion status
11-13	-	Reserved	Not used
14-15	-	Not Supported	Not used

5) Touch probe position 1/2 positive value (60BAh - 60BDh)

Displays the latch position imported.

Index	Sub-Index	Name / Description	Units	Range	Data Type	Access	PDO	Opmode	EEPROM
60BAh	00h	Touch probe pos1 pos value • Displays the position latched at the rising edge of Touch probe 1.	Command	-2147483648 - 2147483647	I32	ro	TxPDO	ALL	No
60BBh	00h	Touch probe pos1 neg value • Displays the position latched at the falling edge of Touch probe 1.	Command	-2147483648 - 2147483647	I32	ro	TxPDO	ALL	No
60BCh	00h	Touch probe pos2 pos value • Displays the position latched at the rising edge of Touch probe 2.	Command	-2147483648 - 2147483647	I32	ro	TxPDO	ALL	No
60BDh	00h	Touch probe pos2 neg value • Displays the position latched at the falling edge of Touch probe 2.	Command	-2147483648 - 2147483647	I32	ro	TxPDO	ALL	No

6) Starting touch probe operation

When the bits 0/8 (Touch probe start/stop) of 60B8h(Touch probe function) is changed from 0 (Stop) to 1 (Start), imports various setting conditions (60B8h: Bits 1 - 7/Bits 9 - 15) and starts the Touch probe operation.

To enable the change of various setting conditions, put back the Bit 0/Bit 8 to 0 (Stop) once and then set the Bit 0/Bit 8 to 1 (Start) again.

7) Event mode of touch probe

The Bit 1/Bit 9 (Select event mode) of 60B8h (Touch probe function) enable to select 0 (Trigger first event)/ 1 (Continuous) mode.

<Trigger first event mode> (60B8h: Bit 1 = 0/Bit 9 = 0)

After the startup, this mode is latched only by the first trigger signal.
To import the signal again, restart the touch probe function.

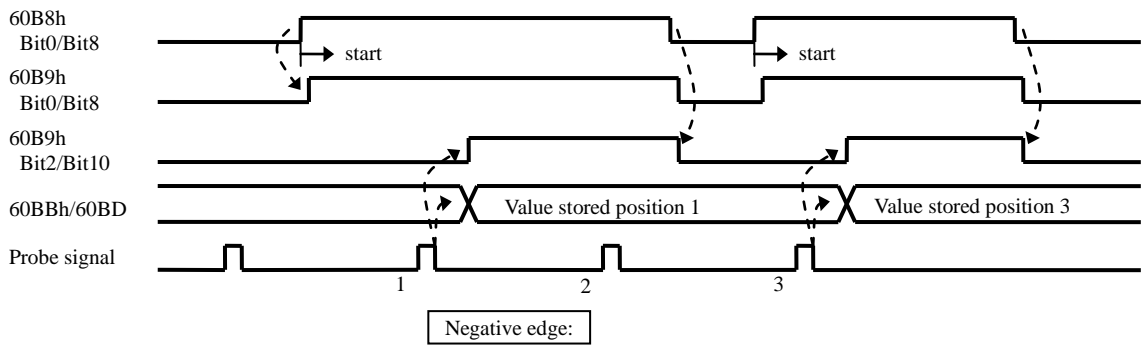
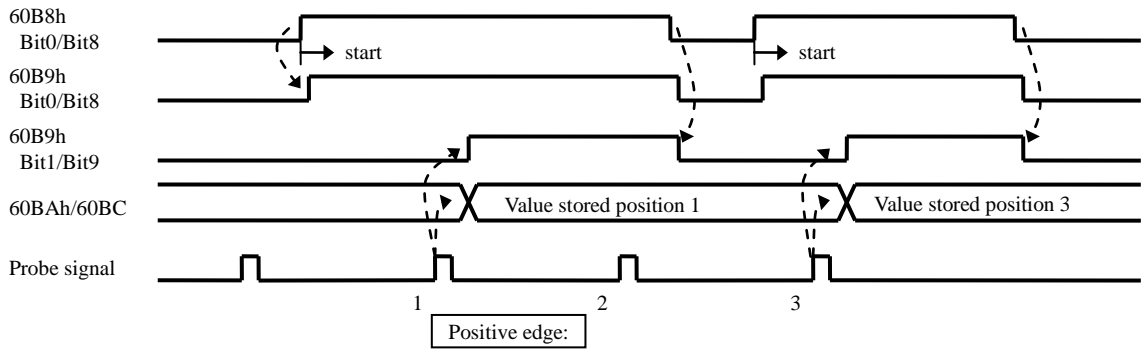

<Continuous mode> (60B8h: Bit 1 = 1/Bit 9 = 1)

After the startup, this mode is latched each time the trigger signal is detected.
A stored value is retained until the next probe signal.

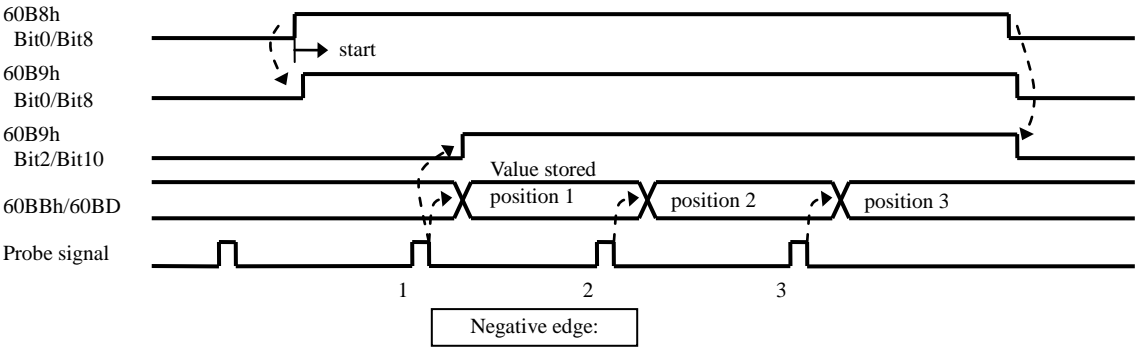
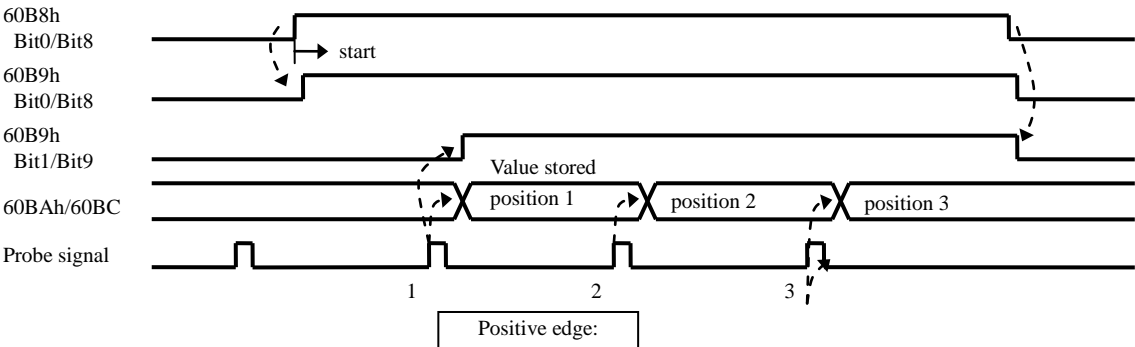

6-9-2 Option Code (deceleration stop sequence)

Sets how to decelerate and stop the motor if main power is shut down or an alarm occurs while PDS is Operation enabled state (servo-on state).

Combine the deceleration function (option code) defined by CoE(CiA402) and the deceleration function on the servo (MINAS-A5) side (dynamic brake stop, free-run stop, immediate stop).

- PDS option code list

Index	Sub-Index	Name	Units	Range	Data Type	Access	PDO
6007h	00h	Abort connection option code	-	0 - 3	I16	rw	No
605Ah	00h	Quick stop option code	-	0 - 7	I16	rw	No
605Bh	00h	Shutdown option code	-	0 - 1	I16	rw	No
605Ch	00h	Disable operation option code	-	0 - 1	I16	rw	No
605Dh	00h	Halt option code	-	1 - 3	I16	rw	No
605Eh	00h	Fault reaction option code	-	0 - 2	I16	rw	No

- Related option code list

Index	Sub-Index	Name / Description	Units	Range	Data Type	Access	PDO	Op-mode	EEPRO M
6084h	00h	Profile deceleration	Command/s ²	0 - 4294967295	U32	rw	RxPDO	pp ip pv	Yes
<ul style="list-style-type: none"> Set the profile deceleration. If it is set to 0, internal processing is treated as 1. 									
6085h	00h	Quick stop deceleration	Command/s ²	0 - 4294967295	U32	rw	RxPDO	pp ip pv hm csp csv	Yes
<ul style="list-style-type: none"> If 605Ah(Quick stop option code) is "2" or "6", is set to value of deceleration parameter to be used deceleration stopping at the time of Quick stop or disable voltage. It is used when 605Dh(Halt option code) and 605Eh(Fault reaction option code) is "2". If it is set to 0, internal processing is treated as 1. 									
6087h	00h	Torque slope	0.1%/s	0 - 4294967295	U32	Rw	RxPDO	tq cst	Yes
<ul style="list-style-type: none"> Set a parameter value for giving slope to a torque command. In the cyclic synchronous torque mode (cst), torque slope is effective only during the deceleration stop sequence. When 0 has been set, the setting is regarded as 1 internally. 									
609Ah	00h	Homing acceleration	Command/s ²	0 - 4294967295	U32	rw	RxPDO	hm	Yes
<ul style="list-style-type: none"> Set the acceleration and deceleration during the Homing mode (hm). The deceleration of homing operation are common in this object. At the final stop of each Homing method (when the homing position is detected), the servo lock is carried out for the stopping, instead of using the preset value of this object. If it is set to 0, internal processing is treated as 1. 									
60C6h	00h	Max deceleration	Command/s ²	0 - 4294967295	U32	rw	RxPDO	pp hm pv ip	Yes
<ul style="list-style-type: none"> Set the maximum deceleration. If it is set to 0, internal processing is treated as 1. 									

Index	Sub-Index	Name / Description	Units	Range	Data Type	Access	PDO	Op-mode	EEPROM
3506h	00h	Sequence at Servo-Off - Set the state after stop and during deceleration in the following cases: when 605Ah (Quick stop option code) is "0" and Quick stop is accepted; when 605Bh (Shutdown option code) is "0" and Shutdown or Disable voltage is accepted; when 605Ch (Disable operation option code) is "0" and Disable operation is accepted; when 6007h (Abort connection option code) is "2", 605Bh is "0", and power is shut off; or when 6007h (Abort connection option code) is "3", 605Ah is "0", and power is shut off. For more information, refer to Section 6-3-2"Sequence at Servo-Off" of the Specification for basic functions(SX-DSV02472).	—	0 - 9	I16	rw	No	ALL	Yes
3510h	00h	Sequence at alarm - Set to state after the stop during deceleration at the time of alarm occurrence. For more information, refer to Section 6-3-2"Sequence at Servo-Off" of the Specification for basic functions(SX-DSV02472).	—	0 - 7	I16	rw	No	ALL	Yes

If other deceleration factors (such as an alarm) occur during deceleration, the deceleration is performed according to the following priority. Basically, the deceleration function on the servo (MINAS-A5) side has a higher priority.

Servo (MINAS-A5) side deceleration > Fault deceleration > CoE (CiA402) side deceleration (*1)
> Limit system deceleration (*2) > Halt deceleration > Normal deceleration
(*1) It means deceleration by the quick stop, shutdown and disable operation.
(*2) The deceleration by the drive prohibition (POT/NOT) and software limit

If a deceleration factor with a higher priority occurs, the process is switched to that deceleration process even if a preceding deceleration operation is in process.

If a deceleration factor of the lower level of priority occurs, the deceleration operation accepted first will be retained.

Example) When an alarm occurs during deceleration by 605Ah (Quick stop option code), the deceleration level switches to that of 605Eh (Fault reaction option code) from the point where the alarm occurred.

1) Abort connection option code(6007h)

Sets how to decelerate and stop the motor when main power off physically.

The operation sequence of main power-off state changes by combination of 6007h(Abort connection option code), 3508h(L/V trip selection upon main power off), 3509h(Detection time of main power off) etc.

The following table indicates the operation sequence by a combination of these.

Index	Sub-Index	Name / Description	Units	Range	Data Type	Access	PDO	Op-mode	EEPROM
6007h	00h	Abort connection option code <ul style="list-style-type: none"> When physical main power supply interception occurs, The sequence of deceleration stop to be executed between the Up to the power supply interception detection time set up at 3509h(Detection time of main power off) from after power supply interception 70ms(*1) is set up. In the case of 3509h=2000, only the sequence of deceleration stop set up by this object is performed. It is prohibition of a setup except the following value. <p>0: No action 1: Fault signal (Deceleration according to 605Eh(Fault reaction option code)) 2: Disable voltage command (Deceleration according to 605Bh(Shutdown option code)) 3: Quick stop command (Deceleration according to 605Ah(Quick stop option code))</p>	-	0 - 3	I16	rw	No	ALL	Yes
3507h	00h	Sequence upon main power off <ul style="list-style-type: none"> Set the deceleration mode on the servo (MINAS-A5) side (sequence when main power is off). Set status during deceleration and status after stop when bit0 of 3508h (L/V trip selection upon main power off) is set to "0" and a value other than "2000" is set for 3509h (Detection time of main power off) with main power off. For more information, refer to Section 6-3-3"Sequence at main power off" of the Specification for basic functions(SX-DSV02472).	—	0 - 9	I16	rw	No	ALL	Yes
3508h	00h	L/V trip selection upon main power off <ul style="list-style-type: none"> Select to perform servo off or LV trip at time of main power alarm. <p>bit0 0:perform servo off according to setting of 6007h(Abort connection option code) or 3507h(Sequence upon main power off). 1:Detected Err13.1"Main power supply undervoltage protection " bit1 0:The main power off warning only detected servo state 1:The main power off warning always detected</p>	—	0 - 3	I16	rw	No	ALL	Yes
3509h	00h	Detection time of main power off <ul style="list-style-type: none"> Set the time of the main power supply alarm detection. The main power off detection is invalid in the case of 2000 setting. (Note: Even if 2000 is set, the deceleration process on the CoE (CiA402) side will not be ineffective.) Resolution setting is 2ms. For example, if the setting value is 99, is processed in 100ms.	1ms	70 - 2000	I16	rw	No	ALL	Yes

There is a related object also to others.

For more information, refer to beginning of section 6-9-2.

Index	Sub-Index	Name	Units	Range	Data Type	Access	PDO
6084h	00h	Profile deceleration	Command/s ²	0 - 4294967295	U32	rw	RxPDO
6085h	00h	Quick stop deceleration	command/s ²	0 - 4294967295	U32	rw	RxPDO
6087h	00h	Torque slope	0.1%/s	0 - 4294967295	U32	rw	RxPDO
609Ah	00h	Homing acceleration	Command/s ²	0 - 4294967295	U32	rw	RxPDO
60C6h	00h	Max deceleration	Command/s ²	0 - 4294967295	U32	rw	RxPDO
3506h	00h	Sequence at Servo-Off	—	0 - 9	I16	rw	No
3510h	00h	Sequence at alarm	—	0 - 7	I16	rw	No

The following table shows the operation sequence for each combination of objects.

Basically, the deceleration function defined in CoE(CiA402) is effective until the deceleration function on the servo (MINAS-A5) side is activated by detection of the insulation of the main power AC (between L1 and L3).

- When “No action” is set by 6007h = 0, the CoE(CiA402) deceleration function does not operate, and the deceleration function on the servo (MINAS-A5) side operates.
- When the voltage between P and N decreases, Err13.0 (Main power undervoltage protection (PN)) occurs with the highest priority, causing the operation in accordance with 3510h (Sequence at alarm).

Refer to Section 6-3-3 “Sequence at main power off” in Basic function specifications of the Technical document (SX-DSV02472) as well.

a) In case of 3509h = 2000 (When detection of the insulation of the main power AC is invalid)

State	Setting value of 6007h	Setting value of target option code	Deceleration method
At the time of undervoltage between P and N	-	-	Decelerate according to 3510h after Err13.0 occurrence
At the time of insulating main power AC (between L1-L3)	0 (No action)	-	Hold the operation state
	1 (Fault signal)	605Eh=0	Decelerate according to 3510h after Err88.0 occurrence
		Except 605Eh=0	Err88.0 occurrence after deceleration according to 605Eh
	2 (Disable voltage command)	605Bh=0	Decelerate according to 3506h
		Except 605Bh=0	Decelerate according to 605Bh
	3 (Quick stop command)	605Ah=0	Decelerate according to 3506h
Except 605Ah=0		Decelerate according to 605Ah	

b) In case of 3509h ≠ 2000 (When detection of the insulation of the main power AC is valid)

State	Setting value of 6007h	Setting value of target option code	Deceleration method			
			Before elapse of time set in 3509h	After elapse of time set in 3509h → 3508h (bit0)		
At the time of undervoltage between P and N	-	-	Decelerate according to 3510h after Err13.0 occurrence			
At the time of insulating main power AC (between L1-L3)	0 (No action)	-	Hold the operation state	→	0	Decelerate according to 3507h
					1	Decelerate according to 3510h after Err13.1 occurrence
	1 (Fault signal)	605Eh=0	Decelerate according to 3510h after Err88.0 occurrence	→	0	Decelerate according to 3507h
					1	Decelerate according to 3510h after Err13.1 occurrence (Err88.0 occurrence after deceleration)
					0	Decelerate according to 3507h
					1	Decelerate according to 3510h after Err13.1 occurrence (Err88.0 occurrence after deceleration)
	2 (Disable voltage command)	605Bh=0	Decelerate according to 3506h	→	0	Decelerate according to 3507h
					1	Decelerate according to 3507h
		Except 605Bh=0	Decelerate according to 605Bh	→	0	Decelerate according to 3507h
					1	Decelerate according to 3510h after Err13.1 occurrence
	3 (Quick stop command)	605Ah=0	Decelerate according to 3506h	→	0	Decelerate according to 3507h
					1	Decelerate according to 3507h
Except 605Ah=0		Decelerate according to 605Ah	→	0	Decelerate according to 3507h	
				1	Decelerate according to 3510h after Err13.1 occurrence	

*1) Deceleration is not executed if the actual speed has reached 30 r/min or below before the time set for 3509h elapses.

Example of the deceleration and stop due to physical main power shut-down

- A: The slowdown stop by 6007h is started 70ms after main power OFF.
- B: If the time set up at 3509h after the main power supply OFF passes, it will change to the slowdown stop by 3507h.
- C: After detecting actual velocity 30 r/min or less, the motor stops.
- D: If the main power is turned ON, 6041h:bit4 (Status word: voltage enabled) changes to 1.

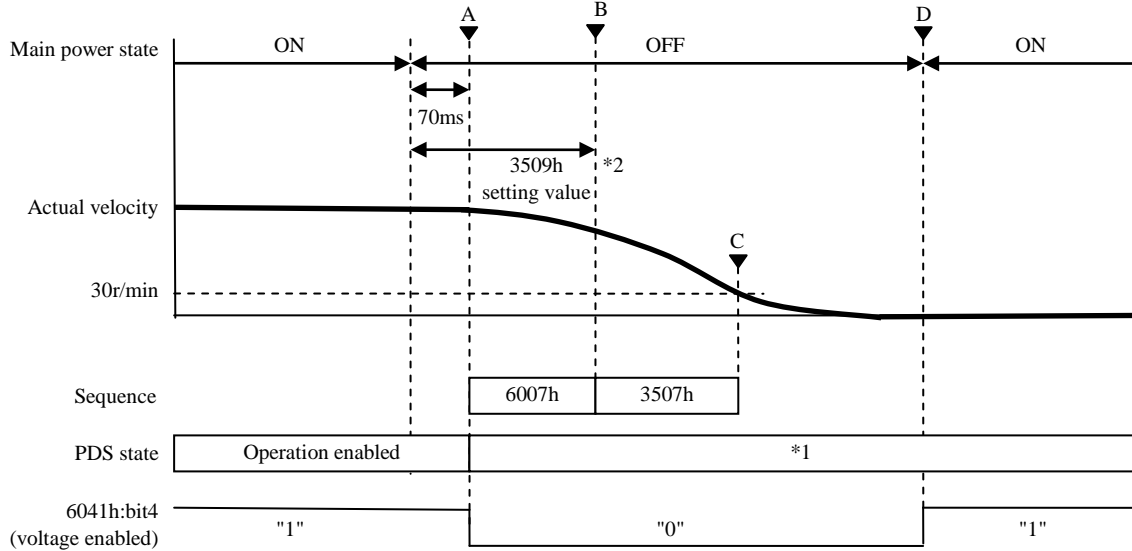

*1 The PDS state under slowdown and after a stop changes with this object and preset values 3508h(bit0) and 3509h. Refer to the following page table.

*2 If actual velocity becomes 30 or less r/min when 3509h = 2000 (detection of main power AC insulation invalid) and before the time set up at 3509h passed, deceleration and stop processing by 3507h is not carried out.

PDS state during deceleration and stop

- Before the time progress set up at 3509 h, or 3509h = 2000 (detection of main power AC insulation invalid)

6007h's Value *1)	PDS state during deceleration	PDS state after stop (about 30 r/min or less)
0	Hold the current state	When PDS state is Operation enabled at the time of main power-off: Operation enabled When PDS state is Quick stop active at the time of main power-off: Switch on disabled
1	Fault reaction active	Fault
2	Hold the current state	Switch on disabled
3	Quick stop Active	Switch on disabled

*1) It is not dependent on the preset value of 3508h(bit0).

- After the time progress set up at 3509h

6007h's Value	Target Option code value	3508h's (bit 0) Value	PDS state during deceleration	PDS state after stop (approx. 30 r/min or less)
0	-	0	Current state is maintained.	When PDS state is Operation enabled at the time of main power-off: Ready to switch on When PDS state is Quick stop active at the time of main power-off: Switch on disabled
		1	Fault reaction active	Fault
1	-	-	Fault reaction active	Fault
2	605Bh=0	-	Current state is maintained.	Ready to switch on
	Other than 605Bh=0	0	Current state is maintained.	Ready to switch on
3	Other than 605Ah=0	1	Fault reaction active	Fault
		-	Quick stop active	Switch on disabled
		0	Quick stop active	Switch on disabled
		1	Fault reaction active	Fault

2) Quick stop option code(605Ah)

Sets how to decelerate and stop the motor when the PDS command "Quick Stop" is accepted.

Index	Sub-Index	Name / Description	Units	Range	Data Type	Access	PDO	Op-mode	EEPROM
605Ah	00h	Quick stop option code	-	0 - 7	I16	rw	No	ALL	Yes
<ul style="list-style-type: none"> • Set the sequence during "Quick Stop" or "Disable voltage". The definition can differ according to the operation mode. Other than the values below are disabled. ■ pp, csp, ip, csv, pv <ol style="list-style-type: none"> 0: After the motor stops due to 3506h (Sequence during servo-off), moves to Switch on disabled. 1: After the motor stops due to 6084h (Profile linear deceleration constant), moves to Switch on disabled. 2: After the motor stops due to 6085h (Quick stop deceleration), moves to Switch on disabled. 3: After the motor stops due to 60C6h(Max deceleration), moves to Switch on disabled. 5: After the motor stops due to 6084h (Profile linear deceleration constant), moves to Quick stop active. 6: After the motor stops due to 6085h (Quick stop deceleration), moves to Quick stop active. 7: After the motor stops due to 60C6h(Max deceleration), moves to Quick stop active. ■ hm <ol style="list-style-type: none"> 0: After the motor stops due to 3506h (Sequence during servo-off), moves to Switch on disabled. 1: After the motor stops due to 609Ah (Homing acceleration constant), moves to Switch on disabled. 2: After the motor stops due to 6085h(Quick stop deceleration), moves to Switch on disabled. 3: After the motor stops due to 60C6h(Max deceleration), moves to Switch on disabled. 5: After the motor stops due to 609Ah (Homing acceleration constant), moves to Quick stop active. 6: After the motor stops due to 6085h(Quick stop deceleration), moves to Quick stop active. 7: After the motor stops due to 60C6h(Max deceleration), moves to Quick stop active. ■ cst, tq <ol style="list-style-type: none"> 0: After the motor stops due to 3506h (Sequence during servo-off), moves to Switch on disabled. 1, 2: After the motor stops due to 6087h (Torque slope), moves to Switch on disabled. 3: After the motor stops due to 0 torque, moves to Switch on disabled. 5, 6: After the motor stops due to 6087h (Torque slope), moves to Quick stop active. 7: After the motor stops due to 0 torque, moves to Quick stop active. <p>(*1) Status is changed to Switch on disabled if main power is shut off at 6007h=3.</p>									

There is a related object also to others.

For more information, refer to beginning of section 6-9-2.

Index	Sub-Index	Name	Units	Range	Data Type	Access	PDO
6084h	00h	Profile deceleration	Command/s ²	0 - 4294967295	U32	rw	RxPDO
6085h	00h	Quick stop deceleration	command/s ²	0 - 4294967295	U32	rw	RxPDO
6087h	00h	Torque slope	0.1%/s	0 - 4294967295	U32	rw	RxPDO
609Ah	00h	Homing acceleration	Command/s ²	0 - 4294967295	U32	rw	RxPDO
60C6h	00h	Max deceleration	Command/s ²	0 - 4294967295	U32	rw	RxPDO
3506h	00h	Sequence at Servo-Off	-	0 - 9	I16	rw	No

Example of deceleration and stop due to Quick Stop

- A: When 6040h: bit 2 (Control word: quick stop) changes from 1 to 0, the deceleration and stop start.
The PDS state during the deceleration is Quick stop active.
- B: After detecting actual velocity 30 r/min or less, the motor stops.
The PDS state after the stop is Switch on disable or Quick stop active.

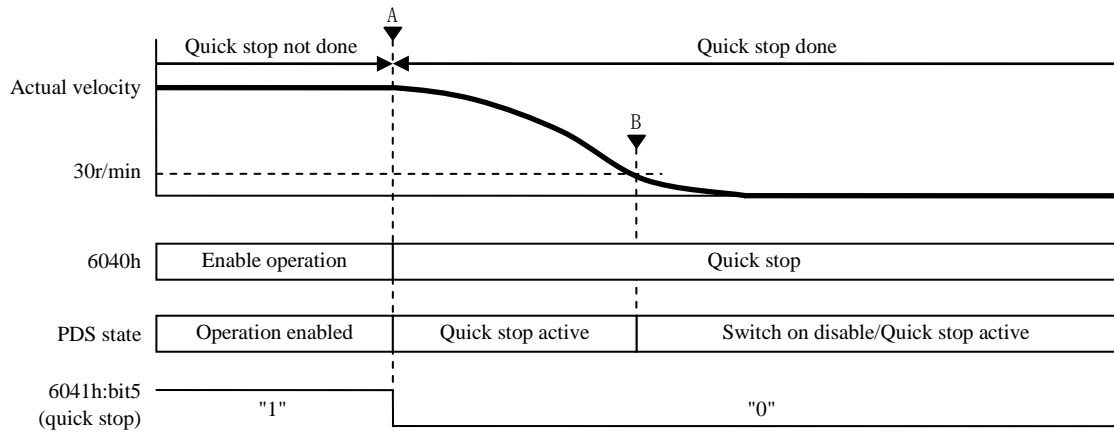

3) Shutdown option code(605Bh)

Sets how to decelerate and stop the motor when the PDS command "Shutdown" or "Disable voltage" is accepted.

Index	Sub-Index	Name / Description	Units	Range	Data Type	Access	PDO	Op-mode	EEPROM
605Bh	00h	Shutdown option code	-	0 - 1	I16	rw	No	ALL	Yes
<ul style="list-style-type: none"> • Set the sequence when the PDS command "Shutdown" is accepted. The definition can differ according to the operation mode. Other than the values below are disabled. <p>(1) The PDS command "Shutdown" is accepted</p> <ul style="list-style-type: none"> ■ pp, csp, ip, csv, pv <ul style="list-style-type: none"> 0: After the motor stops due to 3506h (Sequence during servo-off), changes to Ready to switch on. 1: After the motor stops due to 6084h (Profile linear deceleration constant), changes to Ready to switch on. ■ hm <ul style="list-style-type: none"> 0: After the motor stops due to 3506h (Sequence during servo-off), changes to Ready to switch on. 1: After the motor stops due to 609Ah (Homing acceleration constant), changes to Ready to switch on. ■ cst, tq <ul style="list-style-type: none"> 0: After the motor stops due to 3506h (Sequence during servo-off), changes to Ready to switch on. 1: After the motor stops due to 6087h (Torque slope), changes to Ready to switch on. <p>(2) The PDS command "Disable voltage" is accepted.</p> <ul style="list-style-type: none"> ■ pp, csp, ip, csv, pv <ul style="list-style-type: none"> 0: After the motor stops due to 3506h(Sequence at Servo-off), changes Switch on disabled. 1: After the motor stops due to 6084h(Profile deceleration), changes Switch on disabled. ■ hm <ul style="list-style-type: none"> 0: After the motor stops due to 3506h(Sequence at Servo-off), changes Switch on disabled. 1: After the motor stops due to 609Ah(Homing acceleration), changes Switch on disabled. ■ cst, tq <ul style="list-style-type: none"> 0: After the motor stops due to 3506h(Sequence at Servo-off), changes Switch on disabled. 1: After the motor stops due to 6087h(Torque slope), changes Switch on disabled. 									

There is a related object also to others.

For more information, refer to beginning of section 6-9-2.

Index	Sub-Index	Name	Units	Range	Data Type	Access	PDO
6084h	00h	Profile deceleration	Command/s ²	0 - 4294967295	U32	rw	RxPDO
6087h	00h	Torque slope	0.1%/s	0 - 4294967295	U32	rw	RxPDO
609Ah	00h	Homing acceleration	Command/s ²	0 - 4294967295	U32	rw	RxPDO
3506h	00h	Sequence at Servo-Off	—	0 - 9	I16	rw	No

Example of deceleration and stop due to Shutdown command

- A: When the PDS command "Shutdown" is accepted, the deceleration and stop start.
The PDS state keeps Operation enabled during the deceleration.
- B: After detecting actual velocity 30 r/min or less, the motor stops.
The PDS state will be Ready to switch on after the stop.

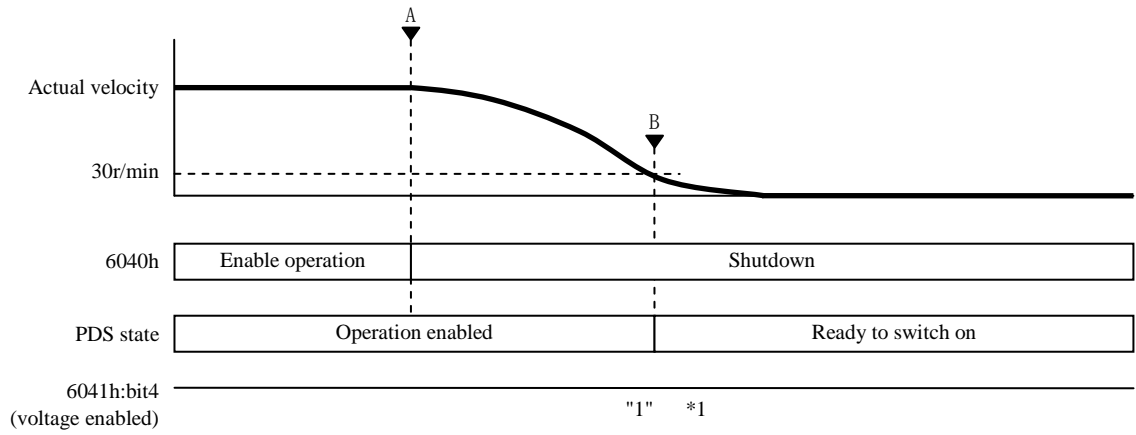

*1): 6041h: bit 4 (Status word: voltage enabled) remains 1.

4) Disable operation option code (605Ch)

Sets how to decelerate and stop the motor when the PDS command "Disable operation" is accepted.

Index	Sub-Index	Name / Description	Units	Range	Data Type	Access	PDO	Op-mode	EEPROM
605Ch	00h	Disable operation option code	-	0 - 1	I16	rw	No	ALL	Yes
<ul style="list-style-type: none"> • Set the sequence during Disable Operation. The definition can differ according to the operation mode. Other than the values below are disabled. <ul style="list-style-type: none"> ■ pp, csp, ip, csv, pv <ul style="list-style-type: none"> 0: After the motor stops due to 3506h (Sequence during servo-off), moves to Switched on. 1: After the motor stops due to 6084h (Profile linear deceleration constant), moves to Switched on. ■ hm <ul style="list-style-type: none"> 0: After the motor stops due to 3506h (Sequence during servo-off), moves to Switched on. 1: After the motor stops due to 609Ah (Homing acceleration constant), moves to Switched on. ■ cst, tq <ul style="list-style-type: none"> 0: After the motor stops due to 3506h (Sequence during servo-off), moves to Switched on. 1: After the motor stops due to 6087h (Torque slope), moves to Switched on. 									

There is a related object also to others.

For more information, refer to beginning of section 6-9-2.

Index	Sub-Index	Name	Units	Range	Data Type	Access	PDO
6084h	00h	Profile deceleration	Command/s ²	0 - 4294967295	U32	rw	RxPDO
6087h	00h	Torque slope	0.1%/s	0 - 4294967295	U32	rw	RxPDO
609Ah	00h	Homing acceleration	Command/s ²	0 - 4294967295	U32	rw	RxPDO
3506h	00h	Sequence at Servo-Off	-	0 - 9	I16	rw	No

Example of deceleration and stop due to servo-off

- A: If the servo amplifier accepts to PDS command "Disable operation", the deceleration and stop start. The PDS state keeps Operation enabled during the deceleration.
- B: After detecting actual velocity 30 r/min or less, the motor stops. The PDS state will be Switched on after the stop.

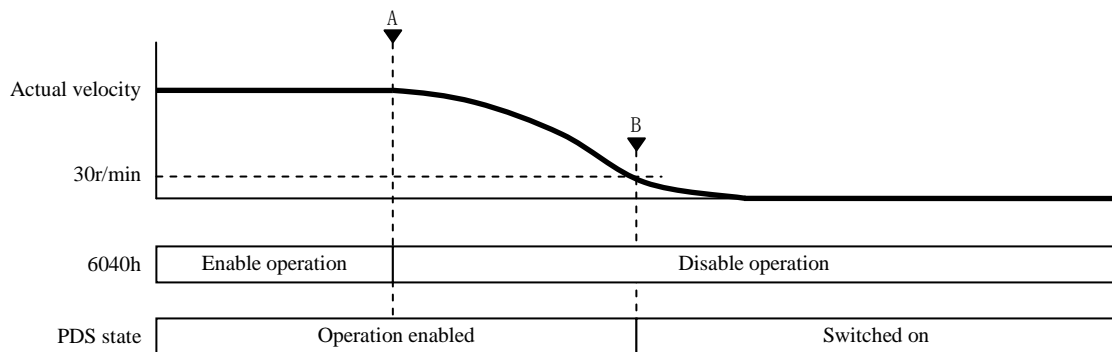

5) Halt option code (605Dh)

Sets how to decelerate and stop the motor when the halt bit of 6040h (Control word) is set to 1.

Index	Sub-Index	Name / Description	Units	Range	Data Type	Access	PDO	Op-mode	EEPROM
605Dh	00h	Halt option code	-	1 - 3	I16	rw	No	ALL	Yes
<ul style="list-style-type: none"> • Set how to stop the motor during the Halt operation. The definition can differ according to the operation mode. Other than the values below are disabled. ■ pp, csp, ip, csv, pv <ol style="list-style-type: none"> 1: After the motor stops due to 6084h (Profile linear deceleration constant), keeps Operation enabled. 2: After the motor stops due to 6085h (Quick stop deceleration), keeps Operation enabled. 3: After the motor stops due to 6072h (Max torque),60C6h (Max deceleration), keeps Operation enabled. ■ hm <ol style="list-style-type: none"> 1: After the motor stops due to 609Ah (Homing acceleration constant), keeps Operation enabled. 2: After the motor stops due to 6085h (Quick stop deceleration), keeps Operation enabled. 3: After the motor stops due to 6072h (Max torque),60C6h (Max deceleration), keeps Operation enabled. ■ cst, tq <ol style="list-style-type: none"> 1, 2: After the motor stops due to 6087h (Torque slope), keeps Operation enabled. 3: After the motor stops due to the 0 torque, keeps Operation enabled. 									

There is a related object also to others.

For more information, refer to beginning of section 6-9-2.

Index	Sub-Index	Name	Units	Range	Data Type	Access	PDO
6084h	00h	Profile deceleration	Command/s ²	0 - 4294967295	U32	rw	RxPDO
6087h	00h	Torque slope	0.1%/s	0 - 4294967295	U32	rw	RxPDO
609Ah	00h	Homing acceleration	Command/s ²	0 - 4294967295	U32	rw	RxPDO

Example of deceleration and stop due to the Halt function

- A: When 6040h: bit 8 (Control word: halt) changes from 0 to 1, the deceleration and stop start.
The PDS state keeps Operation enabled during the deceleration.
- B: After detecting actual velocity 30 r/min or less, the motor stops.
The PDS state keeps Operation enabled after the stop.

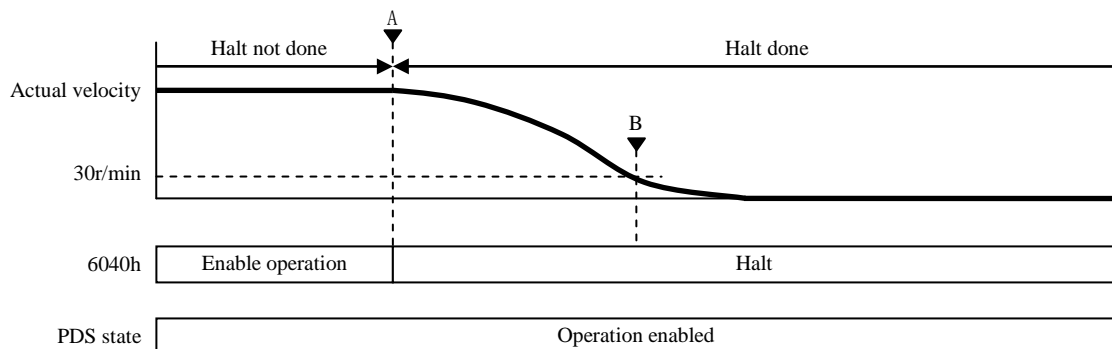

6) Fault reaction option code (605Eh)

Sets how to decelerate and stop the motor when an alarm occurs.

Index	Sub-Index	Name / Description	Units	Range	Data Type	Access	PDO	Op-mode	EEPROM
605Eh	00h	Fault reaction option code	-	0 - 2	I16	rw	No	ALL	Yes
<ul style="list-style-type: none"> Set the sequence during the Fault reaction. The definition can differ according to the operation mode. Other than the values below are disabled. <p>(1) On occurrence of Err80.0-80.7, 81.0-81.7, 85.0-85.7, and 88.0-88.7</p> <ul style="list-style-type: none"> pp, csp, ip, csv, pv <ul style="list-style-type: none"> 0: After the motor stops due to 3510h (Sequence at alarm), moves to Fault. 1: After the motor stops due to 6084h (Profile linear deceleration constant), moves to Fault. 2: After the motor stops due to 6085h (Quick stop deceleration), moves to Fault. hm <ul style="list-style-type: none"> 0: After the motor stops due to 3510h (Sequence at alarm), moves to Fault. 1: After the motor stops due to 609Ah (Homing acceleration constant), moves to Fault. 2: After the motor stops due to 6085h (Quick stop deceleration), moves to Fault. cst, tq <ul style="list-style-type: none"> 0: After the motor stops due to 3510h (Sequence at alarm), moves to Fault. 1, 2: After the motor stops due to 6087h (Torque slope), moves to Fault. <p>(2) On occurrence of other than alarms specified by the term above (1)</p> <ul style="list-style-type: none"> 0, 1, 2: After the motor stops due to 3510h (Sequence at alarm), moves to Fault. 									

There is a related object also to others.

For more information, refer to beginning of section 6-9-2.

Index	Sub-Index	Name	Units	Range	Data Type	Access	PDO
6084h	00h	Profile deceleration	Command/s ²	0 - 4294967295	U32	rw	RxPDO
6085h	00h	Quick stop deceleration	command/s ²	0 - 4294967295	U32	rw	RxPDO
6087h	00h	Torque slope	0.1%/s	0 - 4294967295	U32	rw	RxPDO
609Ah	00h	Homing acceleration	Command/s ²	0 - 4294967295	U32	rw	RxPDO
3510h	00h	Sequence at alarm	-	0 - 7	I16	rw	No

Example of deceleration and stop due to alarm occurrence

A: When an alarm occurs, the deceleration and stop start.

The PDS state during the deceleration is Fault reaction active.

B: After detecting actual velocity 30 r/min or less, the motor stops.

The PDS state will be Fault after the stop.

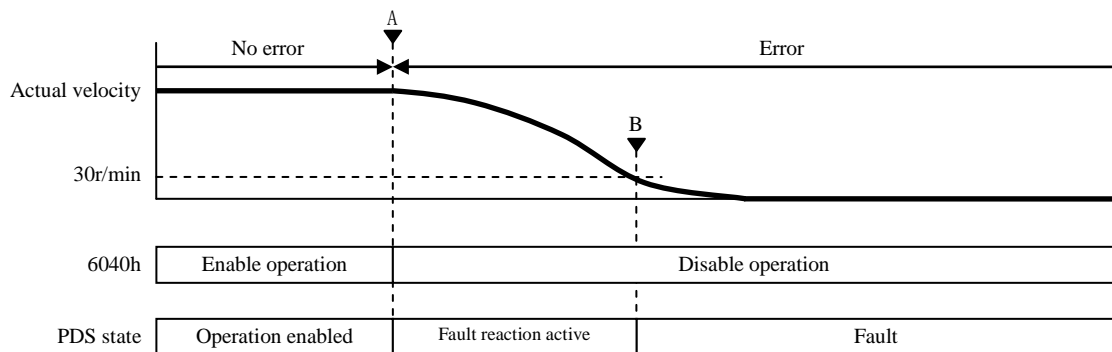

7) Sequence at drive inhibition input (POT, NOT)

Sets the operation sequence after the input of drive inhibition input (POT, NOT).

For more information, see Section 6-3-1 in Basic function specifications of the Technical document (SX-DSV02472).

- Related object

Index	Sub-Index	Name / Description	Units	Range	Data Type	Access	PDO	Op-mode	EEPROM
3504h	00h	Over-travel inhibit input setup - Sets the operation after input of drive inhibition input (POT, NOT). 0: Functions as POT; inhibition of positive direction drive and NOT; inhibition of negative direction drive. When POT is input during positive direction operation, or NOT is input during negative direction operation, the operation stops in accordance with 3505h (Sequence at over-travel inhibit). 1: Functions as POT, inhibition of positive direction drive and NOT, inhibition of negative direction drive. When POT is input during positive direction operation, or NOT is input during negative direction operation, the operation stops according to the following. ■ pp, csp, ip, csv, pv, hm Motor is stopped by 6085h (Quick stop deceleration). ■ cst, tq Motor is stopped by 6087h (Torque slope). 2: Err38.0 (Over-travel inhibit input protection 1) occurs when either POT or NOT is input. For more information, refer to Section 6-3-1 "Sequence upon inputting of over-travel inhibition (POT, NOT)" in Basic function specifications of the Technical document (SX-DSV02472).	—	0 - 2	I16	rw	No	ALL	Yes
3505h	00h	Sequence at over-travel inhibit - Sets the state after stop during deceleration after input of drive inhibition input (POT, NOT) when 3504h (Over-travel inhibit input setup) is "0". For more information, refer to Section 6-3-1 "Sequence upon inputting of over-travel inhibition (POT, NOT)" in Basic function specifications of the Technical document (SX-DSV02472).	—	0 - 2	I16	rw	No	ALL	Yes

There is a related object also to others.

For more information, refer to beginning of section 6-9-2.

Index	Sub-Index	Name	Units	Range	Data Type	Access	PDO
6085h	00h	Quick stop deceleration	command/s ²	0 - 4294967295	U32	rw	RxPDO
6087h	00h	Torque slope	0.1%/s	0 - 4294967295	U32	rw	RxPDO

(Note) If NOT is set for positive operation direction or POT is set for negative operation direction, operations cannot be guaranteed when a sensor has been installed incorrectly.

6-9-3 Digital Inputs/Digital Outputs

The bits of Digital inputs/Digital outputs represent the input state of positive limit switch(POT), negative limit switch(NOT), and home switch(HOME), each logical input state of EXT1-EXT2, E-STOP and SI-MON1-SI-MON5 and logical output state of EX-OUT1 and set_brake of all the function signals allocated by the servo parameters 3400h to 3407h, 3410h, and 3411h.

Here, for information on the signal allocation and logical setting, refer to the technical document "Basic function specifications"(SX-DSV02472).

1) Digital inputs (60FDh)

Index	Sub-Index	Name / Description	Units	Range	Data Type	Access	PDO	Op-mode	EEPROM	
60FDh	00h	Digital inputs • Indicate the logical input state of external input signal.	-	0 - 4294967295	U32	ro	TxPDO	ALL	No	
		Bit	31	30	29	28	27	26	25	24
		Function	(Not Supported)							[INP]
		Bit	23	22	21	20	19	18	17	16
		Function	[SI-MON5] / [E-STOP]	[SI-MON4]	[SI-MON3]	[SI-MON2] / [EXT2]	[SI-MON1] / [EXT1]	(reserved)		
		Bit	15	14	13	12	11	10	9	8
		Function	(reserved)							
		Bit	7	6	5	4	3	2	1	0
		Function	(reserved)				(Not Supported)	home switch [HOME]	positive limit switch [POT]	negative limit switch [NOT]
		* In the brackets, the code names of the I/O connector input signal and output signal are shown.								

The details of each bit are as follows:

Value	Definition
0	Switched off (logical input state is OFF)
1	Switched on (logical input state is ON)

The Bit 2 (Home switch), Bit 1 (Positive limit switch), and Bit 0 (Negative limit switch) of 60FDh (Digital Inputs) represent the home input signal (HOME), positive overtravel input signal (POT), and negative overtravel input signal (NOT) of parallel I/O connector.

2) Digital outputs (60FEh)

(SAFETY PRECAUTIONS)

When performing set brake signal control using this object, be sure to use the PDO and enable the PDO watchdog.

SDO cannot judge communication cut-off, therefore brakes may not work and becomes non-safe.

4.00 When use set brake signal, please set the output signal assignment(Setting of 3410h, 3411h, and 3412h).

Also, when use the brake release signal(BRK-OFF) without using the set brake, please set the output signal assignment(Setting of 3410h, 3411h, and 3412h).

For details, refer to Technical document (Basic function specifications) SX-DSV02472, 2-4-2 “Assignment of output signal” and 9-2 ”Timing Chart“.

Index	Sub-Index	Name / Description	Units	Range	Data Type	Access	PDO	Op-mode	EEPRO M		
60FEh	-	Digital outputs • Used to manipulate the output transistor of the external output signal.	-	-	-	-	-	-	-		
		bit	31	30	29	28	27	26	25	24	
		function	(Not Supported)								
		bit	23	22	21	20	19	18	17	16	
		function	(Not Supported)							EX-OUT1	
		bit	15	14	13	12	11	10	9	8	
		function	(reserved)								
		bit	7	6	5	4	3	2	1	0	
		function	(reserved)							set brake	
	00h		Number of entries • Displays the number of sub-indexes of 60FEh.	-	2	U8	ro	No	ALL	No	
01h		Physical outputs • manipulate the output of the external output signal.	-	0 - 4294967295	U32	rw	RxPDO	ALL	Yes		
02h		Bit mask • Set the output operation of external output signal mask function for digital output.	-	0 - 4294967295	U32	rw	RxPDO	ALL	Yes		



Following are details of each bit.

Subindex 01h : Physical outputs

Bit	Name	value	Note
0	set brake	0	don't set brake(brake does not operate)
		1	set brake(brake operates)
16	EX-OUT1	0	Switched off (output transistor OFF)
		1	Switched on (output transistor ON)

Subindex 02h : Bit mask

Bit	Name	value	Note
0	set brake Bit mask	0	Disable output (Set brakeoutput disabled)
		1	Enable output (Set brakeoutput enabled)
16	EX-OUT1 Bit mask	0	Disable output (EX-OUT 1 output disabled)
		1	Enable output (EX-OUT 1 output enabled)

*Note: When the Bit mask is disabled, each physical output other than set break are processed as the default value (= 0) in the amplifier.

The output state changes as follows in each communication state:

Sign	Setting value of 3724h	Setting value of 60FEh		State of output			
		01h (Physical outputs)	02h (Bit mask)	Reset	Communication established *1)	Communication intercepted *1)	Communication re-established *1)
set brake	-	0	0	set brake = 1 (brake on)	set brake = 1 (brake on)	set brake = 1 (brake on)	set brake = 1 (brake on)
		1					
		0	1	set brake = 1 (brake on)	^{2.00} set brake = 0	set brake = 1 (brake on)	^{2.00} set brake = 0
		1			set brake = 1 (brake on)		set brake = 1 (brake on)
EX-OUT 1	bit0 = 0 (hold)	0	0	EX-OUT1 = 0	EX-OUT1 = 0	EX-OUT1 = 0	EX-OUT1 = 0
		1					
		0	1	EX-OUT1 = 0	EX-OUT1 = 0	EX-OUT1 = 0 (hold)	EX-OUT1 = 0
		1			EX-OUT1 = 1	EX-OUT1 = 1 (hold)	EX-OUT1 = 1
	bit0 = 1 (initialization)	0	0	EX-OUT1 = 0	EX-OUT1 = 0	EX-OUT1 = 0	EX-OUT1 = 0
		1					
		0	1	EX-OUT1 = 0	EX-OUT1 = 0	EX-OUT1 = 0	EX-OUT1 = 0
		1			EX-OUT1 = 1		EX-OUT1 = 1

*1) “Communication established”, “Communication intercepted”, and “Communication re-established” refer to the following cases.

Communication established		ESM state is PreOP or higher
Communication intercepted (Note)	When 60FEh is mapped to RxPDO	PDO communication is disabled (ESM state transitioned to other states than OP)
	When 60FEh is not mapped to RxPDO	SDO communication is disabled (ESM state transitioned to Init)
Communication re-established		Until 60FEh-01h or 60FEh-02h is successfully written

(Note) When using 60FEh (Digital output), map it to RxPDO.

• Related objects

Index	Sub-Index	Name / Description	Units	Range	Data Type	Access	PDO	Op-mode	EEPROM
3724h	00h	Communication function extended setup 3 <ul style="list-style-type: none"> bit0: The state setting of EX-OUT1 output at the time of communication interception after communication established of the EtherCAT (ESM state is more than PreOP) 0 : hold 1 : Initialization(output at EX-OUT1=0) bit1: Used by the manufacturer Fix it to 0. 	—	-32768 - 32767	I16	rw	No	ALL	Yes

6-9-4 Position information

1) Initialization timing of position information

This servo amplifier initializes (presets) the position information related object shown below at the time of communication establishment (ESM state is at the transition from Init to PreOP).

- 6062h (Position demand value)
- 6063h (Position actual internal value)
- 6064h (Position actual value)
- 60FCh (Position demand internal value)

These objects are based on 6063h (Position actual internal value) which shows the feedback position of a motor, the code translation by the electronic gear function, Polarity, and Home offset which are mentioned later are considered, and it is initialized (preset) at the time of communication establishment.

Hence, the changes of preset values of the code translation by an electronic gear function, Polarity, and Home offset are performed at the time of initialization (presetting) when communication is established.

Please confirm "4) Initialization of the absolute encoder" mentioned later about notes at the time of using an absolute encoder.

2) Electronic Gear Function

The electronic gear is a function which makes the value which multiplies by the electronic gear ratio defined by the object to the position command from host controller as the position command to a position control section. By using this function, the number of revolutions and travel of the motor per command can be set to the desired value.

In MINAS-A5B series, a setup of an electronic gear ratio with a parameter Pr0.08(Number of command pulses per motor revolution), Pr0.09(Numerator of electronic gear) and Pr0.10(Denominator of electronic gear) has not corresponded, an electronic gear ratio is set up by the object 608Fh(Position encoder resolution), 6091h(Gear ratio) and 6092h(Feed constant) specified to CoE(CiA402).

The equation below calculates the relationship between the unit (command) defined by the user and internal unit (pulse):

$$\text{Electronic gear ratio} = \frac{\text{Position encoder resolution} \times \text{Gear ratio}}{\text{Feed constant}}$$

$$\text{Position demand value} \times \text{Electronic gear ratio} = \text{Position demand internal value}$$

(Note) - Electronic gear ratio is valid only within the range of 1000 times to 1/1000 times.

When the range is exceeded, the value is saturated in the range, and Err88.3 (Improper operation error protection) occurs.

- When the denominator or numerator exceeds the unsigned 64-bit size in the calculation process of electronic gear ratio, Err88.3 (Improper operation error protection) occurs.
- When the denominator or numerator exceeds the unsigned 32-bit size in the final calculation result of electronic gear ratio, Err88.3 (Improper operation error protection) occurs.
- Set the electronic gear ratio with several objects.
An error may become large depending on the combination of settings.
- 608Fh-01h (Encoder increments) is automatically set according to encoder resolution.
The default value of 6092h-01h (Feed) is set so that the electronic gear ratio is 1:1 when a 20-bit/r encoder is used.
When using other encoders than a 20-bit/r encoder, pay attention to the electronic gear ratio settings.
- Electronic gear ratio setting is performed at the timing when the status changes from Init to PreOP and at the completion of the return to home position operation.
Note that the setting is not reflected as is even if the setting values for the related objects have been changed.
- In the position information initialization when Init changes to PreOp in the absolute mode, make a setting so that the value of "Absolute encoder position [pulse/unit]/Electronic gear ratio" is in the range from -2^{31} (-2147483648) to $+2^{31}-1$ (2147483647).
Operations out of this range are not guaranteed.
Check the operation range of the absolute encoder position and the electronic gear ratio.
- The unit of the movement amount setting of the test run function by the setup support tool PANATERM is [pulse], not [command unit], so care should be taken.

<Electronic gear setting example>

In the MINAS-A5B series, it is impossible to set the electronic gear using the “number of command pulses per motor revolution (Pr0.08)” and “electronic gear numerator (Pr0.09)/denominator (Pr0.10)” in contrast to the MINAS-A5N series. ^{2.00}

When setting the electronic gear like the MINAS-A5N, refer to the following.

- When setting the electronic gear ratio by setting the number of command pulses per motor revolution

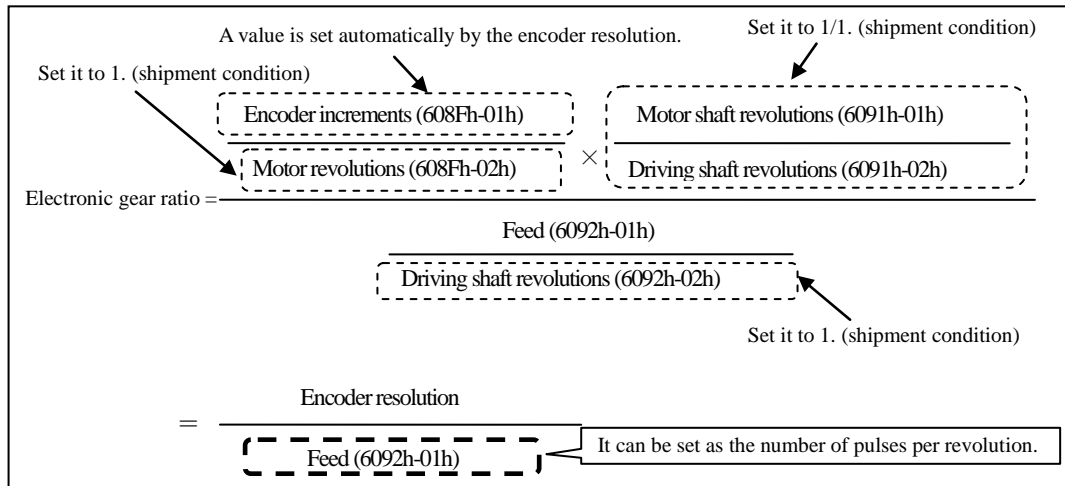

608Fh-01h (Encoder increments) is set automatically from the connected encoder resolution. By setting 608Fh-02h (Motor revolutions), 6091h-01h (Motor shaft revolutions), 6091h-02h (Driving shaft revolutions) and 6092h-02h (Driving shaft revolutions) to 1 (shipment condition), it is possible to set 6092h-01h (Feed) as the “number of command pulses per motor revolution”.

- When setting the electronic gear ratio by setting the electronic gear numerator/denominator

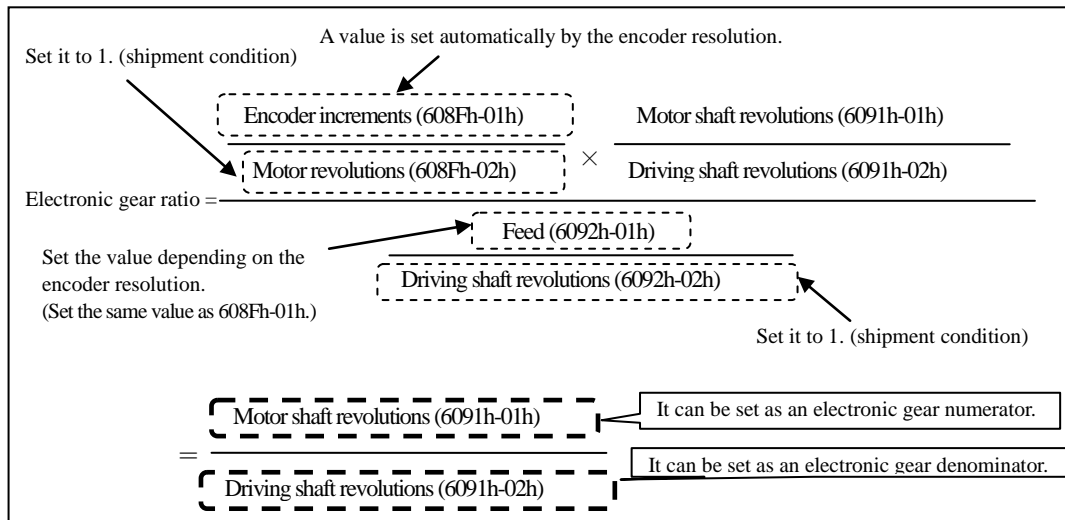

608Fh-01h (Encoder increments) is set automatically from the connected encoder resolution. By setting 6092h-01h (Feed) to the encoder resolution (the same value as 608Fh-01h (Encoder increments)), and in the case of the 20bit/r encoder, the shipment condition and setting 608Fh-02h (Motor revolutions) and 6092h-02h (Driving shaft revolutions) to 1 (shipment condition), it is possible to set 6091h-01h (Motor shaft revolutions) to the “electronic gear numerator” and 6091h-02h (Driving shaft revolutions) to the “electronic gear denominator”.

<Backup of electronic gear set value>

The electronic-gear-related objects (6091h-01h, 6091h-02h, 6092h-01h and 6092h-02h) are backup target objects.

It is recommended to execute a backup (writing into EEPROM) after a change.

By executing a backup, it will be unnecessary to change setting each time when the control power is turned on. As for the backup method, refer to Section 5-6 “Store parameters (EEPROM writing of objects) (1010h)”.

<Electronic gear setting and backup by object editor>

It is possible to set and back up objects using the object editor of PANATERM.

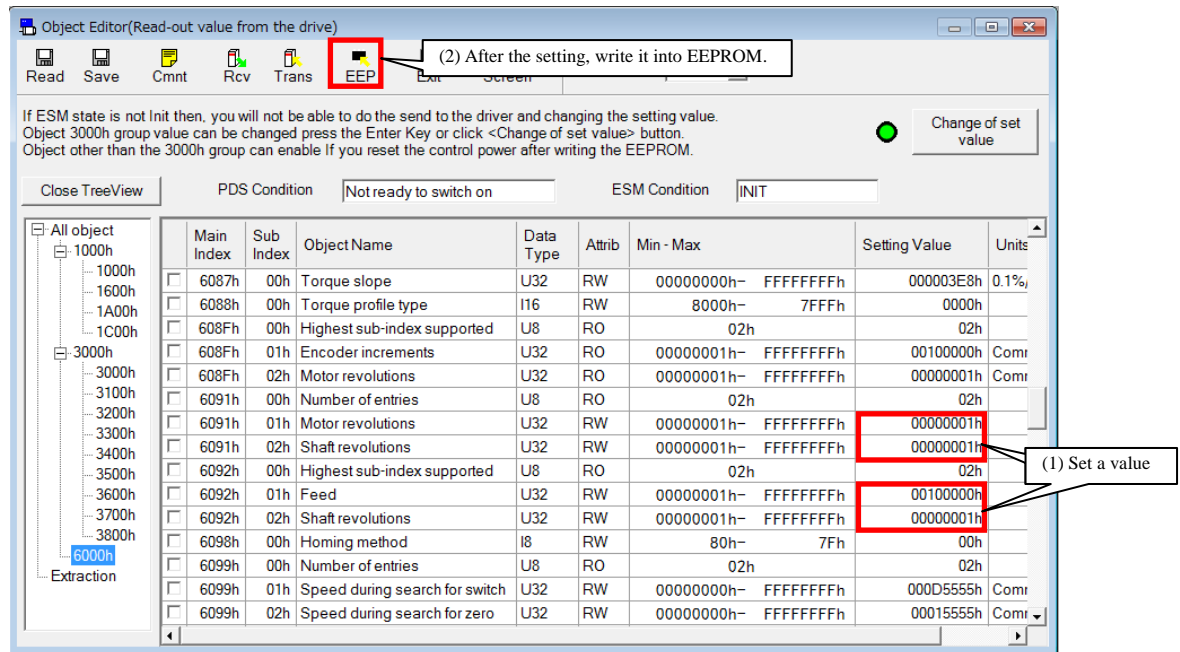

(a) Position encoder resolution(608Fh)

Index	Sub-Index	Name / Description	Units	Range	Data Type	Access	PDO	Op-mode	EEPROM
608Fh		Position encoder resolution • Encoder resolution is set automatically.	-	-	-	-	-	-	-
	00h	Highest sub-index supported • Displays the number of sub-indexes of 608Fh.	-	2	U8	ro	No	ALL	No
	01h	Encoder increments • Indicate the moving amount of the encoder. Encoder resolution is set automatically as the value.	pulse	1 - 4294967295	U32	ro	No	ALL	No
	02h	Motor revolutions • Indicate the rotating speed of motor. The value fixes 1.	r (motor)	1 - 4294967295	U32	ro	No	ALL	No

This object defines the resolution of the encoder per motor revolution.

$$\text{Position encoder resolution} = \frac{\text{Encoder increments(608Fh - 01h)}}{\text{Motor revolutions(608Fh - 02h)}}$$

This object is set up automatically according to the information read out from a motor connected to the servo amplifier.

Example 1) When a 20bit/r encoder is connected.

$$608Fh-01h(\text{Encoder increments}) = 1048576h$$

$$608Fh-02h(\text{Motor revolutions}) = 1h$$

$$\text{Position encoder resolution} = 1048576h / 1h = 1048576h$$

Example 2) When a 17bit/r encoder is connected.

$$608Fh-01h(\text{Encoder increments}) = 131072h$$

$$608Fh-02h(\text{Motor revolutions}) = 1h$$

$$\text{Position encoder resolution} = 131072h / 1h = 131072h$$

(b) Gear ratio(6091h)

Index	Sub-Index	Name / Description	Units	Range	Data Type	Access	PDO	Op-mode	EEPROM
6091h		Gear ratio • Set the gear ratio.	-	-	-	-	-	-	-
	00h	Number of entries • Displays the number of sub-indexes of 6091h.	-	2	U8	ro	No	ALL	No
	01h	Motor revolutions • Set the rotating speed of motor.	r (motor)	1 - 4294967295	U32	rw	No	ALL	Yes
	02h	Shaft revolutions • Set the rotating speed of the shaft.	r (shaft)	1 - 4294967295	U32	rw	No	ALL	Yes

This object defines the relationship between the rotating speeds of motor and shaft after the gearbox output.

$$\text{Gear ratio} = \frac{\text{Motor shaft revolutions(6091h - 01h)}}{\text{Driving shaft revolutions(6091h - 02h)}}$$

(c) Feed constant(6092h)

Index	Sub-Index	Name / Description	Units	Range	Data Type	Access	PDO	Op-mode	EEPROM
6092h		Feed constant • Set the feed constant. feed constant = feed / Shaft revolutions	-	-	-	-	-	-	-
	00h	Highest sub-index supported • Displays the number of sub-indexes of 6092h.	-	2	U8	ro	No	ALL	No
	01h	Feed • Set the feed amount.	command	1 - 4294967295	U32	rw	No	ALL	Yes
	02h	Shaft revolutions • Set the rotating speed of the shaft.	r (shaft)	1 - 4294967295	U32	rw	No	ALL	Yes

This object indicates the operating quantity per rotation of the shaft after the gearbox output.

$$\text{Feed constant} = \frac{\text{Feed(6092h - 01h)}}{\text{Driving shaft revolutions(6092h - 02h)}}$$

3) Polarity(607Eh)

It is possible to set the polarity (rotation direction of motor) for the position command, velocity command, and torque command, and their offset.

In MINAS-A5B series, a setup of the hand of cut by parameter Pr0.00 (Rotational direction) has not corresponded, the hand of cut is set up by object 607Eh (Polarity) specified to CoE (CiA402).

In addition, object 607Eh (Polarity) is not what replaced parameter Pr0.00 (hand-of-cut setup) as it was, It becomes effective when performing the target object of the following table data transfer between a CoE (CiA402) process division and a motor control process division.

Index	Sub-Index	Name / Description	Units	Range	Data Type	Access	PDO	Op-mode	EEPRO M								
607Eh	00h	Polarity <ul style="list-style-type: none"> Select the combination of the command polarities for the position command, velocity command, torque command input, position offset, velocity offset (adding velocity), torque offset (adding torque), position feedback, velocity feedback, and torque feedback from the followings: <p>Note:</p> <p>Setting value of this object set 0(the value of bit7-5 is 0) set so that position, velocity, torque polarity is all the same. Also, set to 224(the value of bit 7-5 is 1). Certified in other settings is not possible.</p> <table border="1"> <thead> <tr> <th>Setting value</th> <th>Description</th> </tr> </thead> <tbody> <tr> <td>0</td> <td>No reverse of sign of torque, velocity, position</td> </tr> <tr> <td>224</td> <td>Reverse of sign of torque, velocity, and position possible</td> </tr> <tr> <td>Other than above</td> <td>Not supported (Do not set)</td> </tr> </tbody> </table> <p>bit 7: Position polarity 0: no sign inversion 1: sign inversion occurs</p> <p>bit 6: Velocity polarity 0: no sign inversion 1: sign inversion occurs</p> <p>bit 5: Torque polarity 0: no sign inversion 1: sign inversion occurs</p> <p>bit4-0 : Reserved - Set to 0.</p> <p>Target object < Instructions / setting ></p> <ul style="list-style-type: none"> - 607Ah(Target position) - 60B0h(Position offset) - 60FFh(Target velocity) - 60B1h(Velocity offset) - 6071h(Target torque) - 60B2h(Torque offset) <p><Monitor ></p> <ul style="list-style-type: none"> - 6062h(Position demand value) - 6064h(Position actual value) - 606Bh(Velocity demand value) - 606Ch(Velocity actual value) - 6074h(Torque demand) - 6077h(Torque actual value) <p>< External input ></p> <ul style="list-style-type: none"> - 60FDh-00h(Digital input) is bit1(positive limit switch(POT)) - 60FDh-00h(Digital input) is bit0(negative limit switch(NOT)) - POT and NOT of external input signal  	Setting value	Description	0	No reverse of sign of torque, velocity, position	224	Reverse of sign of torque, velocity, and position possible	Other than above	Not supported (Do not set)	-	0 - 255	U8	rw	No	ALL	Yes
Setting value	Description																
0	No reverse of sign of torque, velocity, position																
224	Reverse of sign of torque, velocity, and position possible																
Other than above	Not supported (Do not set)																

Data other than the object in the table of a front page, for example, the data of setup support software PANATERM is fixed to CCW direction is positive regardless of 607Eh(Polarity). But, since POT becomes effective at the time of CCW when it operates from PANATERM in test run function, frequency characteristic analysis function, Z phase search function, etc.

When 607Eh(Polarity) is setting to reverse of sign, When you perform a test run etc., please be careful of the logic of the ban on a drive.

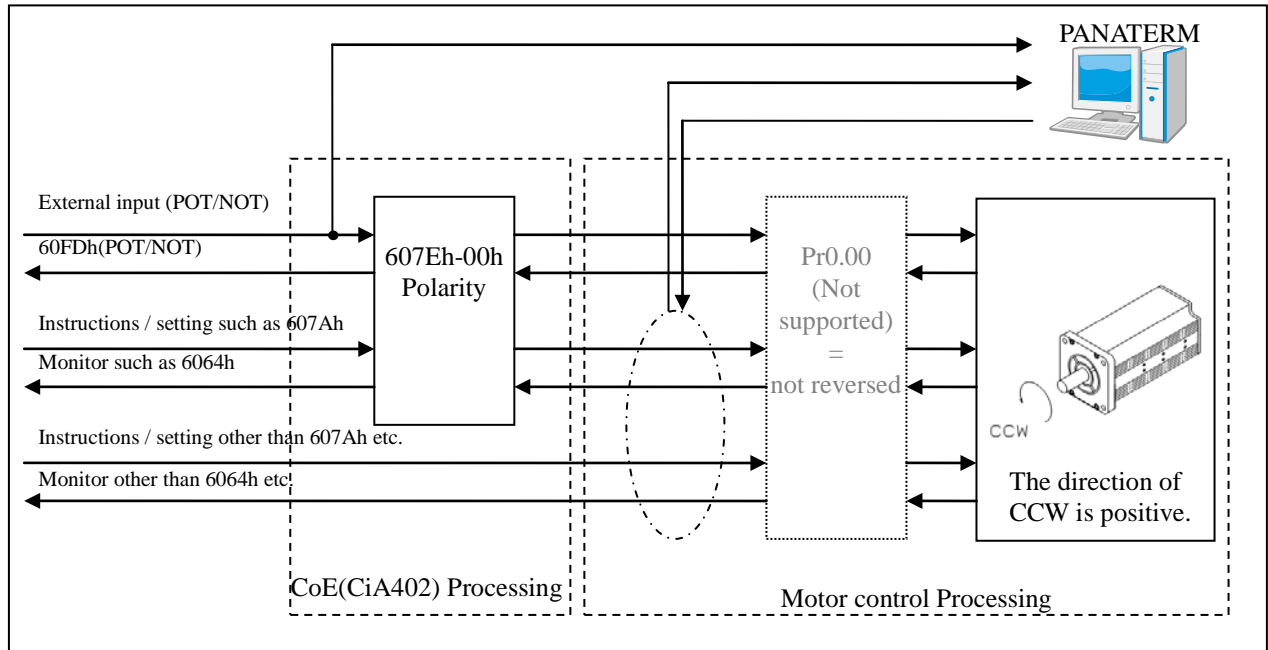

- no sign inversion : Motor turns CCW in response to positive direction command.
- sign inversion occurs : Motor turns CW in response to positive direction command.

*) The direction of motor rotation, it sees from the poll end of a load side, a clockwise rotation is defined as CW, and a counterclockwise rotation is defined as CCW.

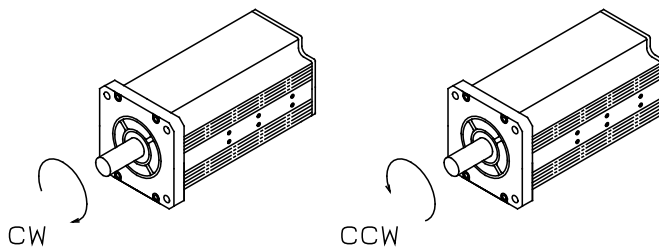

4) Initialization of the absolute encoder

Homing operation is not necessary with the absolute encoder at the position control mode (except when using the absolute encoder as the incremental mode). However, it is necessary to clear “Multi-turn data” at the first start up of the machine after installing the battery.

a) Absolute data

There are 2 types of data which are read out from the absolute encoder (17 bits/r), “Single-turn data” which shows the position of motor’s rotation within a single turn, and “Multi-turn data” which counts each single turn. This Multi-turn data will be backed up by a battery since this is an electrical counter.

Both data have a polarity to increase in the direction of CCW which seen from the motor shaft end.

Be able to select whether Err. 41.0, “Absolute encoder counter overflow” will be generated or not when Multi-turn data has overflowed, with the parameter, 3015h “Absolute encoder setup”.

	Back up at power off	Data width	+/- Sign	Data range
Single-turn data	Not necessary	17 bit	Unsigned	0-131071
Multi-turn data	Backed up by battery	16 bit	Signed	-32768-32767

The servo driver set up position information based on the following formulas at ESM state is at the transition from Init to PreOP.

Since Single-turn data is 17-bit width and Multi-turn data is 16-bit width, the width of the synthetic data will be 33-bit width. However, the servo driver will set the lower 32 bits to the object as position information. Hence, the highest-order bit of 16 bits of the Multi-turn data disappears, making the effective bit length 15 bits.

607Eh (Polarity)	position information
When set to 1 (CCW is positive direction)	$6063h = M \times 2^{17} + S$
	$6064h = (6063h \times \text{Electronic gear conversion value}) + 607Ch$
When set to 224 (CCW is positive direction)	$6063h = -(M \times 2^{17} + S)$
	$6064h = (6063h \times \text{Electronic gear conversion value}) - 607Ch$

6063h : Position actual internal value

6064h : Position actual value

607Ch : Home offset

M : Multi-turn_Data

S : Single-turn_Data

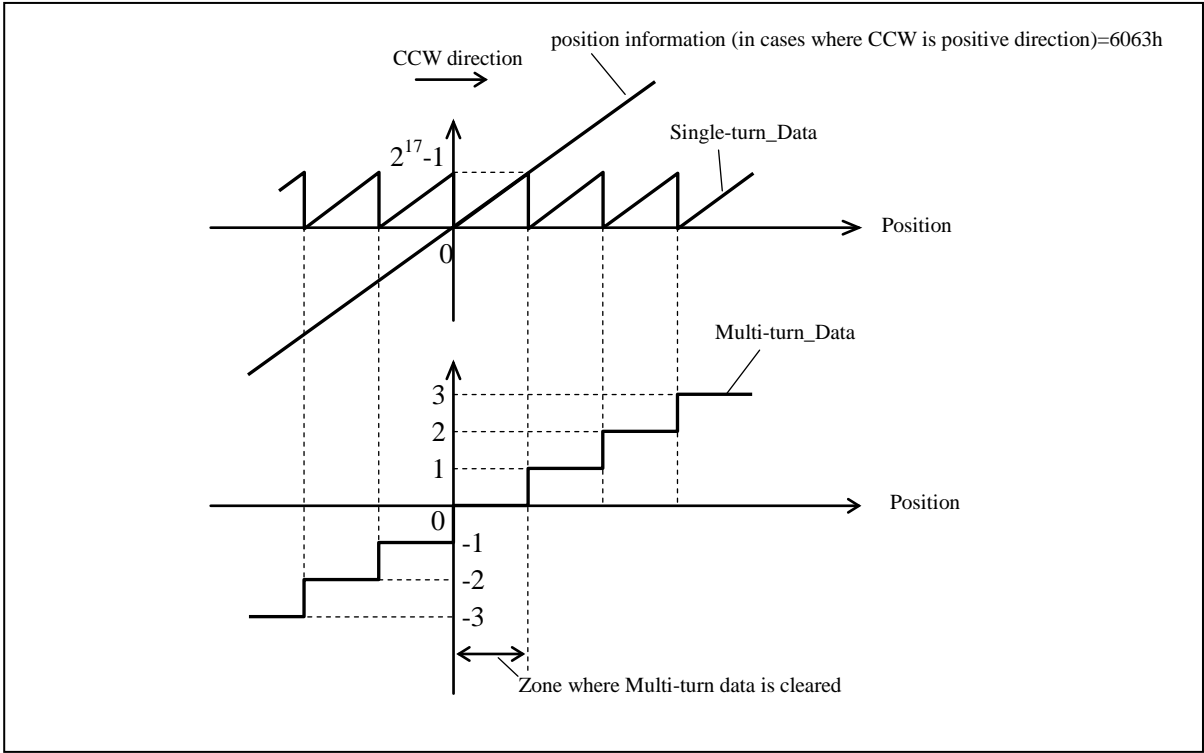

b) Clearing multi-turn data

When clearing multi-turn data, zero position will be multi-turn transition point at CW side in the zone where cleared. In order to avoid the setting difference, execute the clearing operation at the position where single-turn data is 2^{16} which is the farthest from the transition point of multi-turn data.

< Notes to avoid a trouble >

Execute this process (clear multi-turn data) in Servo-OFF (and fixing the moving parts by brake etc. if necessary) and confirming safety.

Keep Servo-OFF until data clearing completes. After that, turn off control power once without fail, and turn on the power again.

It is done to clear multi-turn data using the setup support software "PANATERM" (USB communication). Err. 27.1, "Motion command error" will occur. However, this is not a problem because of a step for safety.



In via EtherCAT communication, multi-turn data clearing operation is possible to run using the 4D00h-01h(Special function start flag 1) and 4D01h-00h(Special function setting 9).

Set the 4D01h-00h(Special function setting 9) to 0031h, and change the bit9 of 4D00h-01h from 0 to 1, the multi-turn data clearing operation will run.

In hm mode, bit 12(homing attained) become 0 when the multi-turn data clear run.

After the multi-turn data clear completion, bit 12 (homing attained) will return to 1.

Index	Sub-Index	Name / Description	Units	Range	Data Type	Access	PDO	Op-mode	EEPROM									
4D00h	-	Special function start Run a special function in accordance with the set value of 4D01h-00h.	-	-	-	-	-	-	-									
	00h	Number of entries Displays the number of sub-indexes for 4D00h.	-	2	U8	ro	No	ALL	No									
	01h	Special function start flag 1 bit0-8 : For manufacturer's use (Please do not change from the default value(0).) bit9 : At the rising edge(0->1) detection of this bit, run the special function in accordance with the set value of 4D01h-00h. After setting this bit to 1, please return to 0 at any time. If return this bit to 0 during running the special function, the special function will continue. bit10-31: For manufacturer's use (Please do not change from the default value(0).)	-	0 – 4294967295	U32	rw	No	ALL	No									
	02h	Special function start flag 2 For manufacturer's use (Please do not change from the default value(0).)	-	0 – 4294967295	U32	rw	No	ALL	No									
4D01h	00h	Special function setting 9 Set value of the following table to this object, and rise(0->1) the bit9 of 4D00h-01h, run the special function in accordance with the set value of 4D01h-00h. After the special function performed, the value of this object will return to 0000h. In the state that it can not multi-turn data clear, the abort message occurs when rise bit9 of 4D00h-01h . In this case, the object does not return to 0000h.	-	0 – 65535	U16	rw	No	ALL	No									
		<table border="1"> <thead> <tr> <th>Value</th> <th>Function</th> </tr> </thead> <tbody> <tr> <td>0000h</td> <td>do nothing.</td> </tr> <tr> <td>0031h</td> <td>Absolute encoder multi-turn data clear</td> </tr> <tr> <td>Other than the above</td> <td>Action indefinite. Please do not set.</td> </tr> </tbody> </table>	Value	Function	0000h	do nothing.	0031h	Absolute encoder multi-turn data clear	Other than the above	Action indefinite. Please do not set.								
Value	Function																	
0000h	do nothing.																	
0031h	Absolute encoder multi-turn data clear																	
Other than the above	Action indefinite. Please do not set.																	

< Precautions for multi-turn data clear via EtherCAT communication >

- Execute in servo-off.
- Do not execute the multi-turn data clear during running the touch probe function.
- Do not execute the ESM transition during running the multi-turn data clear.
- Do not do not change the control mode during running the multi-turn data clear.

- If run multi-turn data clear via EtherCAT communication in the following state, the driver returns the Abort Message “08000022h”.
After confirming that the driver is not in the following state, run the multi-turn data clear via EtherCAT communication.
 - servo-on state.
 - During running the multi-turn data clear
 - When the full closed control setting(3001h=6)
 - When using incremental encoder
 - During running the touch probe function
- ※When an Abort Message occurs, 4D01h-00h(Special function setting 9) does not return to 0000h.

- When execute the multi-turn data clear via EtherCAT communication, Err27.1(Absolute clear protection) does not occur.

5) Position range limit (607Bh)

If the value of 607Ah(Target position) exceeds 607Bh(Position range limit), operated wraparound processing.

Note in the absolute system, because the same wraparound process operates.

In addition, the operation of the guarantee if they have been changed from the default setting set value of 607Bh (Position range limit) is not possible.

Index	Sub-Index	Name / Description	Units	Range	Data Type	Access	PDO	Op-mode	EEPROM
607Bh		Position range limit • Set the boundary position coordinates wrap around.	-	-	-	-	-	-	-
	00h	Highest sub-index supported • Displays the number of sub-indexes for 607Bh (Position range limit).	-	2	U8	ro	No	ALL	No
	01h	Min position range limit • If the setting value is 0, the setting value wraps around from the minimum value to the other range (maximum value). Do not change the value 80000000h (factory default).	Command	-2147483648 - 2147483647	I32	rw	RxPDO	ALL	Yes
	02h	Max position range limit • If the setting value is 0, the setting value wraps around from the maximum value to the other range (minimum number). Do not change the value 7FFFFFFFh (factory default).	Command	-2147483648 - 2147483647	I32	rw	RxPDO	ALL	Yes

[Example of wraparound process]

607Bh-01h(Min position range limit) = 80000000h

607Bh-02h(Max position range limit) = 7FFFFFFFh

In the above case, when 607Ah changes from 7FFFFFFFh to 80000000h. (absolute value movement)

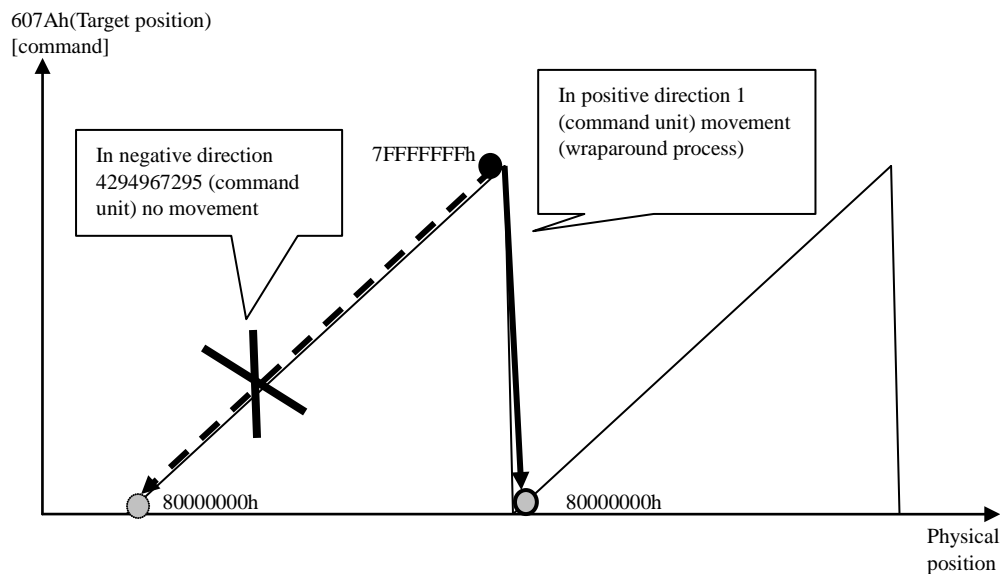

6) Home offset (607Ch)

It can always be updated of this object, the position control mode upon completion of homing (hm), to reflect the actual location of the coordinate system information is only in the timing of the (preset) initialization when communication is established (PreOP transition from Init) It does not.

After detect home position(except Method 36), the following object is initialized (preset) to base on the position at the time of communication established(change from Init to PreOP).

- After detection of home position
 $6062h(\text{Position demand value}) = 6064h(\text{Position actual value}) = 607Ch(\text{Home offset})$
 $6063h(\text{Position actual internal value}) = 60FCh(\text{Position demand internal value}) = 0$
- When communication is established
 $6063h(\text{Position actual internal value}) = 60FCh(\text{Position demand internal value})$
 $6062h(\text{Position demand value}) = 6064h(\text{Position actual value}) = 6063h(\text{Position actual internal value}) + 607Ch(\text{Home offset})$

Note: The above descriptions are for cases where the electronic gear ratio is 1:1 and polarity is not reversed.

Index	Sub-Index	Name / Description	Units	Range	Data Type	Access	PDO	Op-mode	EEPRO M
607Ch	00h	Home offset	Command	-2147483648 - 2147483647	I32	rw	RxPDO	ALL	Yes
		<ul style="list-style-type: none"> • After the homing position control mode (hm), position information is set so that the detected index pulse position becomes equal to the value of this object. Also, it is added to position information at the timing of initialization (preset) of position information when communication is established (change from Init to PreOP). 							

Note: If you do homing, the coordinate system information is reset. Therefore, it is necessary is re-acquired data acquired by the old coordinate system (for example, position Touch probe).

Home position: Position of the Index pulse (home position)
 Zero position: In the case of an incremental system = 0 (position which subtracted Home offset from the position at the time of power activation, or the position of Index pulse detected by hm)
 In absolute system, zero position of absolute encoder

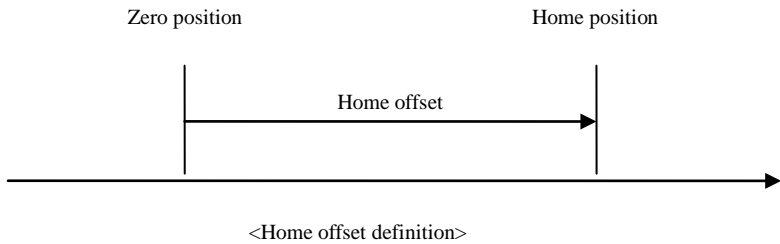

6-9-5 Jerk

This function is not supported by this software version.
Set 6086h (Motion profile type) to 0.

By setting up Jerk, the change rate of the degree of acceleration and deceleration can be smoothed.

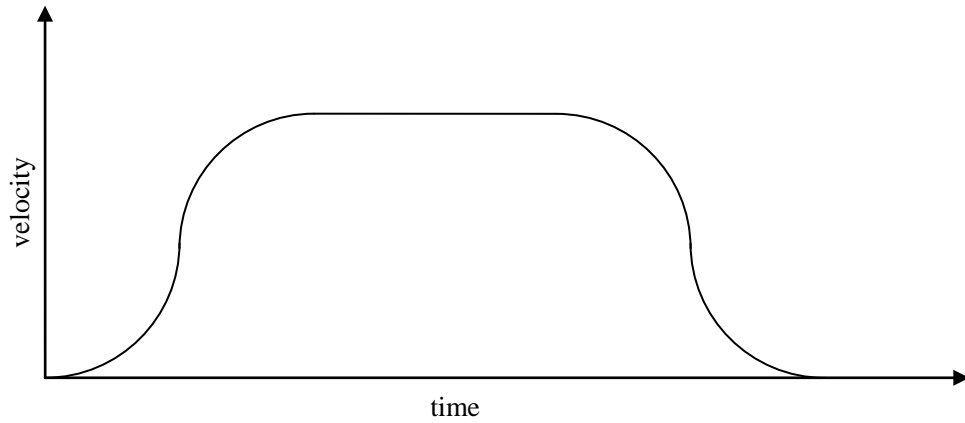

<Velocity/time diagram with jerk positions>

This function cannot be used because it is not supported.

Also, can smooth using 3222h(Positional command smoothing filter) and 3223h(Positional command FIR filter).

For more information, refer to Basic function specifications of the Technical document(SX-DSV02472).

6-9-6 Interpolation time period (60C2h)

60C2h(Interpolation time period) is set up automatically as follows with a communication cycle.

communication cycle	60C2h-01h	60C2h-02h
250us	25	-5
500us	5	-4
1ms	1	-3
2ms	2	-3
4ms	4	-3

Index	Sub-Index	Name / Description	Units	Range	Data Type	Access	PDO	Op-mode	EEPROM
60C2h	-	Interpolation time period • Set the interpolation time cycle.	-	-	-	-	-	-	-
	00h	Highest sub-index supported • Displays the number of sub-indexes for 60C2h (Interpolation time period).	-	2	U8	ro	No	ip csp csv cst	No
	01h	Interpolation time period value • Set the interpolation time cycle value. Set up automatically with a communication cycle.	-	0 - 255	U8	rw	No	ip csp csv cst	Yes
	02h	Interpolation time index • Set the interpolation time index. Set up automatically with a communication cycle.	-	-128 - 63	I8	rw	No	ip csp csv cst	Yes

7 Servo Parameter Area (3000h to 3FFFh)

7-1 Object Overview 229

7-1 Object Overview

The 3000hs objects are allocated to the servo parameters.
(Excluding Class 15)
For more information on the servo parameters, refer to Specification for basic functions (SX-DSV02472).
The correspondence between the servo parameter numbers and object numbers is as follows:

[Servo parameter No]

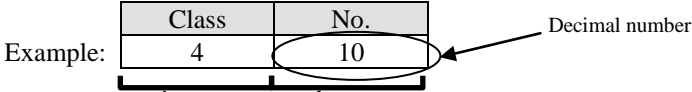

[Object No]

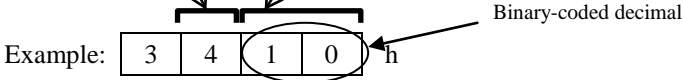

8 EtherCAT Relevant Protection Functions

8-1 Error (alarm) List (attribute and LED display).....	231
1) EtherCAT communication-related error(alarm).....	231
2) Error unrelated to EtherCAT communication(alarm)	232
8-2 EtherCAT-related details of error(alarm).....	234
1) Inaccurate ESM demand error protection (Err80.0).....	234
2) ESM undefined request error protection (Err80.1).....	235
3) Bootstrap requests error protection (Err80.2).....	236
4) Incomplete PLL error protection (Err80.3)	237
5) PDO watchdog error protection (Err80.4).....	238
6) PLL error protection (Err80.6).....	239
7) Synchronization signal error protection (Err80.7).....	240
8) Synchronization cycle error protection (Err81.0).....	242
9) Mailbox error protection (Err81.1).....	243
10) PDO watchdog error protection (Err81.4).....	244
11) DC error protection (Err81.5).....	245
12) SM event mode error protection (Err81.6).....	246
13) SyncManager2/3 error protection (Err81.7)	247
14) TxPDO assignment error protection (Err85.0).....	248
15) RxPDO assignment error protection (Err85.1).....	249
16) Lost link detection error protection (Err85.2)	250
17) SII EEPROM error protection (Err85.3)	251
18) Main power undervoltage protection (AC insulation detection 2) (Err88.0)	252
19) Control mode setting error protection (Err88.1).....	253
20) ESM requirements during operation error protection (Err88.2).....	254
21) Improper operation error protection (Err88.3)	255
8-3 Reading Error (alarm)	256
8-4 Clear error (alarm)/Clear warning	257
8-5 Other, error(alarm) / warning related function.....	258

8-1 Error (alarm) List (attribute and LED display)

The table below lists the LED display and alarm attribute when an error (alarm) occurs:

1) EtherCAT communication-related error(alarm)

Err No		Alarm name	Clearable	Immediate stop *1)	History *2)	ERR Indicator display
Main	Sub					
80	0	ESM unauthorized request error protection	Yes	No	Yes	Blinking
	1	ESM undefined request error protection	Yes	No	Yes	Blinking
	2	Bootstrap requests error protection	Yes	No	Yes	Blinking
	3	Incomplete PLL error protection	Yes	No	Yes	Single flash
	4	PDO watchdog error protection	Yes	No	Yes	Double flash
	6	PLL error protection	Yes	No	Yes	Single flash
	7	Synchronization signal error protection	Yes	No	Yes	Single flash
81	0	Synchronization cycle error protection	Yes	No	Yes	Blinking
	1	Mailbox error protection	Yes	No	Yes	Blinking
	4	PDO watchdog error protection	Yes	No	Yes	Blinking
	5	DC error protection	Yes	No	Yes	Blinking
	6	SM event mode error protection	Yes	No	Yes	Blinking
	7	SyncManager2/3 error protection	Yes	No	Yes	Blinking
85	0	TxPDO assignment error protection	Yes	No	Yes	Blinking
	1	RxPDO assignment error protection	Yes	No	Yes	Blinking
	2	Lost link error protection	Yes	Yes	Yes	Double flash
	3	SII EEPROM error protection	No	No	Yes	Flickering
88	0	Main power undervoltage protection (AC insulation detection 2)	Yes	Yes	No	OFF
	1	Control mode setting error protection	Yes	Yes	Yes	OFF
	2	ESM requirements during operation error protection	Yes	Yes	Yes	OFF
	3	Improper operation error protection	No	Yes	Yes	OFF

2) Error unrelated to EtherCAT communication(alarm)

Err No		Alarm name	Clearable	Immediate stop *1)	History *2)	ERR Indicator display
Main	Sub					
11	0	Control power supply undervoltage protection	Yes	No	No	OFF
12	0	Over-voltage protection	Yes	No	Yes	OFF
13	0	Main power supply undervoltage protection (between P to N)	Yes	Yes	No	OFF
	1	Main power supply undervoltage protection (AC interception detection)	Yes	Yes	No	OFF
14	0	Over-current protection	No	No	Yes	OFF
	1	IPM error protection	No	No	Yes	OFF
15	0	Over-heat protection	No	Yes	Yes	OFF
16	0	Over-load protection	Yes *3)	No	Yes	OFF
	1	Torque saturation error protection	Yes	No	Yes	OFF
18	0	Over-regeneration load protection	No	Yes	Yes	OFF
	1	Over-regeneration Tr error protection	No	No	Yes	OFF
21	0	Encoder communication disconnect error protection	No	No	Yes	OFF
	1	Encoder communication error protection	No	No	Yes	OFF
23	0	Encoder communication data error protection	No	No	Yes	OFF
24	0	Position deviation excess protection	Yes	Yes	Yes	OFF
	1	Speed deviation excess protection	Yes	Yes	Yes	OFF
25	0	Hybrid deviation excess error protection (Not supported)	No	Yes	Yes	OFF
26	0	Over-speed protection	Yes	Yes	Yes	OFF
	1	2nd over-speed protection	Yes	No	Yes	OFF
27	1	Absolute clear protection	No	No	Yes	OFF
	4	directive error protection	No	Yes	Yes	OFF
	6	Operation command contention protection	Yes	No	Yes	OFF
	7	Position information initialization error protection	No	No	Yes	OFF
28	0	Limit of pulse replay error protection (Not supported)	Yes	Yes	Yes	OFF
29	2	Deviation counter overflow protection 2	No	No	Yes	OFF
30	0	Safety detection [Only special product supports this feature.]	Yes	No	No	OFF
33	0	Overlaps allocation error 1 protection	No	No	Yes	OFF
	1	Overlaps allocation error 2 protection	No	No	Yes	OFF
	2	Input function number error 1 protection	No	No	Yes	OFF
	3	Input function number error 2 protection	No	No	Yes	OFF
	4	Output function number error 1 protection	No	No	Yes	OFF
	5	Output function number error 2 protection	No	No	Yes	OFF
	8	Latch input allocation error protection	No	No	Yes	OFF
34	0	Software limit protection	Yes	No	Yes	OFF
	1	One revolution absolute working range error	Yes	No	Yes	OFF
36	0-2	EEPROM parameter error protection	No	No	No	OFF
37	0-2	EEPROM check code error protection	No	No	No	OFF
38	0	Over-travel inhibit input protection 1	Yes	No	No	OFF
	1	Over-travel inhibit input protection 2	Yes	No	No	OFF
40	0	Absolute counter over error protection	Yes *4)	No	Yes	OFF
41	0	Safety detection [Only special product supports this feature]	No	No	Yes	OFF
42	0	Absolute over-speed error protection	Yes *4)	No	Yes	OFF
43	0	Incremental encoder initialization error protection	No	No	Yes	OFF
44	0	Absolute single turn counter error protection / Incremental signal turn counter error protection	No	No	Yes	OFF
45	0	Absolute multi-turn counter error protection / Incremental multi-turn counter error protection	No	No	Yes	OFF

2.00

4.00

Err No		Alarm name	Clearable	Immediate stop *1)	History *2)	ERR Indicator display
Main	Sub					
47	0	Absolute status error protection	No	No	Yes	OFF
48	0	Incremental encoder Z-phase error protection	No	No	Yes	OFF
49	0	Incremental encoder CS signal error protection	No	No	Yes	OFF
50	0	External scale connection error protection (Not supported)	No	No	Yes	OFF
	1	External scale communication error protection (Not supported)	No	No	Yes	OFF
51	0	External scale status 0 error protection (Not supported)	No	No	Yes	OFF
	1	External scale status 1 error protection (Not supported)	No	No	Yes	OFF
	2	External scale status 2 error protection (Not supported)	No	No	Yes	OFF
	3	External scale status 3 error protection (Not supported)	No	No	Yes	OFF
	4	External scale status 4 error protection (Not supported)	No	No	Yes	OFF
	5	External scale status 5 error protection (Not supported)	No	No	Yes	OFF
55	0	A-phase connection error protection	No	No	Yes	OFF
	1	B-phase connection error protection	No	No	Yes	OFF
	2	Z-phase connection error protection	No	No	Yes	OFF
84	3	Synchronous establishment initialization error protection	No	No	Yes	OFF
87	0	Compulsory alarm input protection	Yes	Yes	No	OFF
91	1	Command error protection	Yes	No	Yes	OFF
92	0	Encoder data recovery error protection	No	No	Yes	OFF
	1	External scale data recovery error protection (Not supported)	No	No	Yes	OFF
93	0	Parameter setting error protection 1	No	No	Yes	OFF
	2	Parameter setting error protection 2	No	No	Yes	OFF
	3	External scale connection error protection (Not supported)	No	No	Yes	OFF
	7	Parameter setting error protection 5	No	No	Yes	OFF
94	3	Home position return error protection 2	Yes	No	Yes	OFF
95	0-4	Motor automatic recognition error protection	No	No	No	OFF
98	4	Unusual communication IC initialization	No	No	Yes	OFF
Other		Other error protection	-	-	-	-

*1): The immediate stop indicates the alarm that immediately stops the operation when Object 3510h (Sequence at alarm) is set to 4 - 7. For more information, refer to Specification for basic functions (SX-DSV02472).

*2): A "history" shows whether it leaves error(alarm) generating as a history at error(alarm) developmental time, or it does not leave.

The error(alarm) from which the "history" serves as Yes are saved as a generating history from Subindex06h -13h(Diagnosis message 1 - 14) of 10F3h(Diagnosis history) at developmental time.

*3): When Err16.0" Over-load protection" operates, after generating, it becomes clearable in about 10 seconds. It receives as an alarm clear command, and clear processing is started after being in a clearable state.

*4): When Err40.0" Absolute counter over error protection" and Err42.0" Absolute over-speed error protection" occur, an error clearance cannot be carried out until it performs an absolute clearance.



8-2 EtherCAT-related details of error(alarm)

Only EtherCAT communication-related error(alarm) are published in this chapter.
Please refer to the volume on Functional Specification (SX-DSV02472) for other alarms.

The AL Status Code and ESM status are updated to the latest error status related to the EtherCAT every time an EtherCAT related error is detected.

For the display of PANATERM or 7-segment LED and Abort messages, the Err number detected first is displayed and maintained until the alarm is cleared.

1) Inaccurate ESM demand error protection (Err80.0)

Primary factor	The change state demand which cannot change from the present state was received. Init to SafeOP Init to OP PreOP to OP OP to Bootstrap PreOP to Bootstrap SafeOP to Bootstrap
ESM state to detect	All the ESM states
Synchronous mode to detect	DC, FreeRun, SM2
ESM state after detection	- When the present state is Init, PreOP, or SafeOP: It remains in the present ESM state. - When the present state is OP: SafeOP
ESC register AL Status Code	0011h
Disposition	The change state request of higher rank equipment is checked.
Alarm clear attribute	Clearance is possible.
Display of ERR Indicator	Blinking

2) ESM undefined request error protection (Err80.1)

Primary factor	The change state request which does not have a definition (except the following) was received. 1 : Request Init State 2 : Request Pre-Operational State 3 : Request Bootstrap State 4 : Request Safe-Operational State 8 : Request Operational State
ESM state to detect	All the ESM states
Synchronous mode to detect	DC, FreeRun, SM2
ESM state after detection	- When the present state is Init, PreOP, or SafeOP: It remains in the present ESM state. - When the present state is OP: SafeOP
ESC register AL Status Code	0012h
Disposition	The change state request of higher rank equipment is checked.
Alarm clear attribute	Clearance is possible.
Display of ERR Indicator	Blinking

3) Bootstrap requests error protection (Err80.2)

Primary factor	The following change state request was received. 3 : Request Bootstrap State
ESM state to detect	form Init to Bootstrap
Synchronous mode to detect	DC, FreeRun, SM2
ESM state after detection	Init
ESC register AL Status Code	0013h
Disposition	The change state request of higher rank equipment is checked.
Alarm clear attribute	Clearance is possible.
Display of ERR Indicator	Blinking

4) Incomplete PLL error protection (Err80.3)

Primary factor	Phasing servo and communication(PLL lock) could not be completed even after the lapse of 1s after the start of the synchronization process. Refer to Appendix 1.
ESM state to detect	from PreOP to SafeOP
Synchronous mode to detect	DC, SM2
ESM state after detection	PreOP
ESC register AL Status Code	002Dh
Disposition	<p><In case of DC></p> <ul style="list-style-type: none"> - Check setting of DC mode. - It is checked whether propagation delay compensation or drift compensation is correct. <p><In case of SM2></p> <ul style="list-style-type: none"> - It is checked whether the transmitting timing of PDO from higher rank equipment is constant. - Check whether there is any problem in wiring of an EtherCAT communication cable. - Check whether the excessive noise has started the EtherCAT communication cable.
Alarm clear attribute	Clearance is possible.
Display of ERR Indicator	Single flash

5) PDO watchdog error protection (Err80.4)

Primary factor	bit10 of AL Event Request(0220h) did not turn on the conditions by which an increment is carried out at the time set up in the ESC register addresses 0400h and 0420h. Refer to Appendix 1.
ESM state to detect	SafeOP*1), OP
Synchronous mode to detect	DC, FreeRun, SM2
ESM state after detection	SafeOP
ESC register AL Status Code	001Bh
Disposition	<ul style="list-style-type: none"> - It is checked whether the transmitting timing of PDO from higher rank equipment is constant(not stop). - Increase the timeout value of the PDO watchdog detection. - Check whether there is any problem in wiring of an EtherCAT telecommunication cable. - Check whether the excessive noise has started the EtherCAT communication cable.
Alarm clear attribute	Clearance is possible.
Display of ERR Indicator	Double flash

*1) For this servo amplifier, the watchdog at SM3 (TxPDO) is disabled, and only the watchdog at SM2 (RxPDO) is detected. Hence, the alarm is detected only in the OP state.

6) PLL error protection (Err80.6)

Primary factor	In the ESM state, phasing servo and communication(PLL lock) separated during operation in the state of SafeOP or OP. Refer to Appendix 1.
ESM state to detect	SafeOP, OP
Synchronous mode to detect	DC, SM2
ESM state after detection	SafeOP
ESC register AL Status Code	0032h
Disposition	<p><In case of DC></p> <ul style="list-style-type: none"> - Check setting of DC mode. - It is checked whether propagation delay compensation or drift compensation is correct. <p><In case of SM2></p> <ul style="list-style-type: none"> - It is checked whether the transmitting timing of PDO from higher rank equipment is constant. - Check whether there is any problem in wiring of an EtherCAT communication cable. - Check whether the excessive noise has started the EtherCAT communication cable. <p> - If the error cannot be resolved, shut off and reset the control power.</p>
Alarm clear attribute	Clearance is possible.
Display of ERR Indicator	Single flash

7) Synchronization signal error protection (Err80.7)

Primary factor	More than the threshold value that the omission of the interruption processing by SYNC0 or IRQ set up by bit0-3 of 3742h(Maximum continuation communication error) in after the completion of synchronous processing generated. Refer to Appendix 1.
ESM state to detect	SafeOP, OP
Synchronous mode to detect	DC, SM2
ESM state after detection	SafeOP
ESC register AL Status Code	002Ch
Disposition	<p><In case of DC></p> <ul style="list-style-type: none"> - Check setting of DC mode. - It is checked whether propagation delay compensation or drift compensation is correct. <p><In case of SM2></p> <ul style="list-style-type: none"> - It is checked whether the transmitting timing of PDO from higher rank equipment is constant. - Check whether there is any problem in wiring of an EtherCAT communication cable. - Check whether the excessive noise has started the EtherCAT communication cable. - The preset value of 3742h(Maximum continuation communication error) bit0-3 is enlarged. <p> 4.00 - If the error cannot be resolved, shut off and reset the control power.</p>
Alarm clear attribute	Clearance is possible.
Display of ERR Indicator	Single flash

(Appendix 1.) About the generating conditions of Err80.3 to Err80.7
 The example in DC synchronous is shown in the following figure.
 (In a case SM2 synchronous, SYNC0 signal replaces an IRQ signal.)

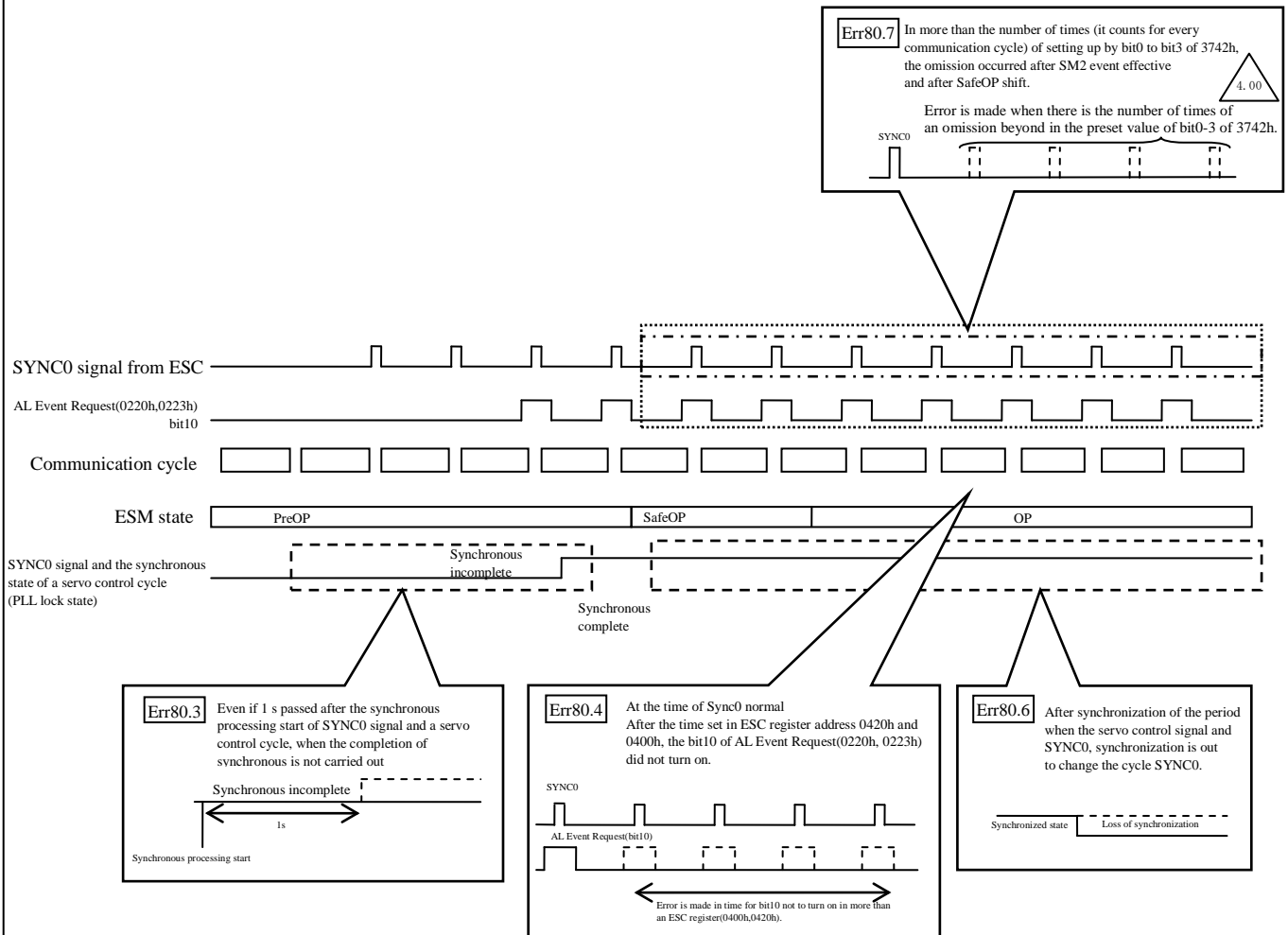

- Related objects



Index	Sub-Index	Name / Description	Units	Range	Data Type	Access	PDO	Op-mode	EEPRO M
3742h	00h	Maximum continuation communication error • Set an upper limit on the number of consecutive occurrences communication error. Bit 0 to 3 : Detection threshold of Err 80.7 (0 to 15 times. When 0 is set, the detection of Err80.7 is disabled.) Bit 4 to 7 : Reserved Bit 8 to 11 : Reserved Bit 12 to 15 : Reserved	—	-32768 - 32767	I16	rw	No	ALL	Yes

8) Synchronization cycle error protection (Err81.0)

Primary factor	If set to cycle synchronization(SYNC0 cycle) is not supported. - It sets except 250000, 500000, 1 million, 2 million, and 4 million [ns] to ESC register SYNC0 Cycle Time (09A0h) and object 1C32h:sub 02h (Cycle time). - The setup of an ESC register and an object is not in agreement.
ESM state to detect	from PreOP to SafeOP
Synchronous mode to detect	DC
ESM state after detection	PreOP
ESC register AL Status Code	0035h
Disposition	Please set up a synchronous period correctly.
Alarm clear attribute	Clearance is possible.
Display of ERR Indicator	Blinking

Primary factor	If set to cycle synchronization(IRQ cycle) is not supported. - It sets except 250000, 500000, 1 million, 2 million, and 4 million [ns] to object 1C32h:sub 02h (Cycle time).
ESM state to detect	from PreOP to SafeOP
Synchronous mode to detect	SM2
ESM state after detection	PreOP
ESC register AL Status Code	0035h
Disposition	Please set up a synchronous period correctly.
Alarm clear attribute	Clearance is possible.
Display of ERR Indicator	Blinking

9) Mailbox error protection (Err81.1)

Primary factor	<p>SM setup of Mailbox is wrong. A setup of SM0/1 was set as the unjust value.</p> <p>- A Physical Start Address:ESC register (0800h and 0801h/0808h,0809h) setup of SyncManager0/1 is inaccurate.</p> <ul style="list-style-type: none"> - The area for reception of Mailbox overlaps the area for transmission. - The area for transmission/reception of Mailbox overlaps the area for transmission/reception of SyncManager2/3 - Address specification of the area for transmission/reception of Mailbox is odd number. - The start address of Mailbox is out of range from SyncManager0: 1000h to 10FFh and SyncManager1: 1200h to 12FFh. <p>- A Length:ESC register (0802h,0803h/080Ah, 080Bh) setup of SyncManager0/1 is inaccurate.</p> <ul style="list-style-type: none"> - Out of range of SyncManager0:32~256byte - Out of range of SyncManager1:40~256byte <p>- A Control Register:ESC register (0804h/080Ch) setup of SyncManager0/1 is inaccurate.</p> <ul style="list-style-type: none"> - Set code other than 100110b in 0804h:bit5-0 - Set code other than 100010b in 080Ch:bit5-0 	
ESM state to detect	from Init to PreOP,PreOP,SafeOP,OP	
Synchronous mode to detect	DC, FreeRun, SM2	
ESM state after detection	Init	
ESC register AL Status Code	0016h	
Disposition	Set the Sync manager correctly in accordance with the ESI file descriptions.	
Alarm clear attribute	Clearance is possible.	
Display of ERR Indicator	Blinking	

10) PDO watchdog error protection (Err81.4)

Primary factor	A setup of the watchdog timer of PDO is wrong. <In case of DC, SM2 mode> Although PDO watch dog trigger is effective (SyncManager: Bit6 which is the register 0804h set to 1), When the detection timeout value of PDO watchdog timer cycle setup (registers 0400h and 0420h) was the "communication cycle x2". <In case of FreeRun mode> Although PDO watch dog trigger is effective (SyncManager: Bit6 which is the register 0804h set to 1), When the detection timeout value of PDO watchdog timer cycle setup (registers 0400h and 0420h) was the following was set as less than 2 ms.
ESM state to detect	from PreOP to SafeOP
Synchronous mode to detect	DC, FreeRun, SM2
ESM state after detection	PreOP
ESC register AL Status Code	001Fh
Disposition	Set up detection timeout value of watchdog timer correctly.
Alarm clear attribute	Clearance is possible.
Display of ERR Indicator	Blinking



11) DC error protection (Err81.5)



Primary factor	DC setting setup is wrong. - A value other than the following was set to bit 2-0 of 0981h (Activation) of the ESC register: Bit 2-0 = 000b Bit 2-0 = 011b
ESM state to detect	from PreOP to SafeOP
Synchronous mode to detect	DC, FreeRun, SM2
ESM state after detection	PreOP
ESC register AL Status Code	0030h
Disposition	Check setting of DC mode.
Alarm clear attribute	Clearance is possible.
Display of ERR Indicator	Blinking

12) SM event mode error protection (Err81.6)

Primary factor	SM event mode which is not supported was set up. - It was set to 1C32h-01h(Sync mode) at values other than 00h(FreeRun), 01h(SM2), and 02h(DC SYNC0). - A value other than 00h (FreeRun), 02h (DC SYNC0), or 22h (SM2) was set to 1C33h-01h (Sync mode). - 000b was set to bit 2-0 of 0981h of the ESC register and SM2 was set to only either 1C32h-01h or 1C33h-01h.
ESM state to detect	from PreOP to SafeOP
Synchronous mode to detect	DC, FreeRun, SM2
ESM state after detection	PreOP
ESC register AL Status Code	0028h
Disposition	- 1C32h-01h(Sync mode) should set up 00h(FreeRun), 01h(SM2), or 02h(DC SYNC0). - 1C33h-01h(Sync mode) should set up 00h (FreeRun), 02h (DC SYNC0), or 22h (SM2). - The setting of 1C32h-01h should be equal to that of 1C33h-01h.
Alarm clear attribute	Clearance is possible.
Display of ERR Indicator	Blinking

13) SyncManager2/3 error protection (Err81.7)

Primary factor	A setup of SyncManager2 was set as the unjust value. <ul style="list-style-type: none"> - A Physical Start Address (ESC register 0810h) setup of SyncManager2 is inaccurate. <ul style="list-style-type: none"> - Receiving area overlaps with the area for the transmission. - The area for transmission/reception of Mailbox overlaps the area for transmission/reception of SyncManager2/3 - Addressing transmission and reception area is an odd number. - Start addresses is out of range. - A Length (ESC register 0812h) setup of SyncManager2 is inaccurate. <ul style="list-style-type: none"> - Different from RxPDO size. - A Control Register:ESC register (0814h) setup of SyncManager2 is inaccurate. <ul style="list-style-type: none"> - Other than 100100b is set for bit5-0. 	
ESM state to detect	from PreOp to SafeOP, SafeOp, Op	
Synchronous mode to detect	DC, FreeRun, SM2	
ESM state after detection	PreOp	
ESC register AL Status Code	001Dh	
Disposition	According to ESI file description, correctly set the Sync Manager 2.	
Alarm clear attribute	Clearance is possible.	
Display of ERR Indicator	Blinking	

Primary factor	A setup of SyncManager3 was set as the unjust value. <ul style="list-style-type: none"> - A Physical Start Address (ESC register 0818h) setup of SyncManager3 is inaccurate. <ul style="list-style-type: none"> - Receiving area overlaps with the area for the transmission. - The area for transmission/reception of Mailbox overlaps the area for transmission/reception of SyncManager2/3 - Addressing transmission and reception area is an odd number. - Start addresses is out of range. - A Length (ESC register 081Ah) setup of SyncManager3 is inaccurate. <ul style="list-style-type: none"> - Different from TxPDO size. - A Control Register:ESC register (081Ch) setup of SyncManager3 is inaccurate. <ul style="list-style-type: none"> - Other than 100000b is set for bit5-0. 	
ESM state to detect	from PreOp to SafeOP, SafeOp, Op	
Synchronous mode to detect	DC, FreeRun, SM2	
ESM state after detection	PreOp	
ESC register AL Status Code	001Eh	
Disposition	According to ESI file description, correctly set the Sync Manager 3.	
Alarm clear attribute	Clearance is possible.	
Display of ERR Indicator	Blinking	

14) TxPDO assignment error protection (Err85.0)

Primary factor	- When the data size of the TxPDO map is set up exceeding 32 bytes.
ESM state to detect	from PreOP to SafeOP
Synchronous mode to detect	DC, FreeRun, SM2
ESM state after detection	PreOP
ESC register AL Status Code	0024h
Disposition	- TxPDO data size is set up within 32 bytes.
Alarm clear attribute	Clearance is possible.
Display of ERR Indicator	Blinking

15) RxPDO assignment error protection (Err85.1)

Primary factor	- When the data size of the RxPDO map is set up exceeding 32 bytes.
ESM state to detect	from PreOP to SafeOP
Synchronous mode to detect	DC, FreeRun, SM2
ESM state after detection	PreOP
ESC register AL Status Code	0025h
Disposition	- RxPDO data size is set up within 32 bytes.
Alarm clear attribute	Clearance is possible.
Display of ERR Indicator	Blinking

16) Lost link detection error protection (Err85.2)

Primary factor	The time set in 3743h (Lost link detection time) elapsed when either Port 0 or Port 1 fell and remains in the lost link state after the ESM state transitioned from Init to PreOP (not including a port that had been in the lost link state at the time of transition from Init to PreOP).
ESM state to detect	PreOP, SafeOP, OP
Synchronous mode to detect	DC, FreeRun, SM2
ESM state after detection	Init
ESC register AL Status Code	0000h
Disposition	- Check whether there is any problem in wiring of an EtherCAT communication cable. - checked whether there is any problem in the communication from higher rank equipment.
Alarm clear attribute	Clearance is possible.
Display of ERR Indicator	Double flash

• Related object

Index	Sub-Index	Name / Description	Units	Range	Data Type	Access	PDO	Op-mode	EEPROM
3722h	00h	Communication function extended setup 1 - When the time set in this parameter elapsed when either Port 0 or Port 1 fell and remains in the lost link state after the ESM state transitioned from Init to PreOP (not including a port that had been in the lost link state at the time of transition from Init to PreOP), Err85.2 (EtherCAT communication interception error) occurs. - When 0 is set, the detection of Err85.2 (Lost link detection error protection) is disabled.	ms	0 - 32767	I16	rw	No	ALL	Yes

Note: This alarm is generated only by the slave that detected a lost link. A subsequent slave that has not detected a lost link does not detect this alarm.

To enable the detection of the alarm by a subsequent slave, assign PDO and enable the PDO watchdog. Note that the default value of 3743h (Lost link detection time) is set to 0 (invalid).

17) SII EEPROM error protection (Err85.3)

Primary factor	- VendorID, Product code, and Revision number do not agree between SII (EEPROM) and the object values. - Reading out from and writing to SII (EEPROM) are improper. - If any of bit11 to14 of ESC register 0502h is set to 1. 
ESM state to detect	All ESM states
Synchronous mode to detect	DC, FreeRun, SM2
ESM state after detection	Init
ESC register AL Status Code	0051h
Disposition	Check the data of SII. Retry reading out from and writing to SII.
Alarm clear attribute	Clearance is not possible.
Display of ERR Indicator	Flickering

18) Main power undervoltage protection (AC insulation detection 2) (Err88.0)

Primary factor	Main circuit power supply OFF was detected when the preset value of 6007h (Abort connection option code) is 1 and the PDS state is "Operation Enabled" or "Quick stop active".
ESM state to detect	OP, SafeOP, PreOP
Synchronous mode to detect	DC, FreeRun, SM2
ESM state after detection	It remains in the present ESM state.
ESC register AL Status Code	0000h
Disposition	<ul style="list-style-type: none"> - The capacity rise of power supply voltage. A power supply is changed. The cause by which the magnetic contactor of the main power supply fell is removed, and a power supply is switched on again. - Each phase (L1, L2, L3) of a power supply is connected correctly. The single phase 100V and the single phase 200V should use L1 and L3. - It replaces with new servo amplifier.
Alarm clear attribute	Clearance is possible.
Display of ERR Indicator	OFF

19) Control mode setting error protection (Err88.1)

Primary factor	<ul style="list-style-type: none"> - The PDS state was changed to "Operation enabled" when the value set to 6060h (Modes of operation) is 0 and the value set to 6061h (Modes of operation display) is 0. - A control not supported by 6060h (Modes of operation) was set. - A mode other than position control was set to 6060h (Modes of operation) in full-closed control. - A mode other than position control was set to 6060h (Modes of operation) in 2 degrees of freedom control. 
ESM state to detect	All the ESM states
Synchronous mode to detect	DC, FreeRun, SM2
ESM state after detection	It remains in the present ESM state.
ESC register AL Status Code	0000h
Disposition	Check preset value of 6060h(Modes of operation).
Alarm clear attribute	Clearance is possible.
Display of ERR Indicator	Blinking

20) ESM requirements during operation error protection (Err88.2)

Primary factor	When a PDS state was "Operation enabled" or "Quick stop active", the ESM state received the changes command to other ESM states.
ESM state to detect	OP, SafeOP, PreOP
Synchronous mode to detect	DC, FreeRun, SM2
ESM state after detection	A state transition request from higher rank equipment is followed.
ESC register AL Status Code	0000h
Disposition	Check the state transition request from higher rank equipment.
Alarm clear attribute	Clearance is possible.
Display of ERR Indicator	Blinking

21) Improper operation error protection (Err88.3)

Primary factor	<ul style="list-style-type: none"> - When EXT1/EXT2 is not assigned to input signal, EXT1/EXT2 was selected in trigger selection of a touch probe (60B8h (Touch probe function)). - When Z-phase is chosen by trigger selection of a touch probe (60B8h(Touch probe function)) at the time of absolute mode of full-colse. - When the software limit function is enabled, a wraparound occurred to the actual position or command position.
ESM state to detect	OP, SafeOP, PreOP
Synchronous mode to detect	DC, FreeRun, SM2
ESM state after detection	It remains in the present ESM state.
ESC register AL Status Code	0000h
Disposition	<ul style="list-style-type: none"> - Set up the functional allotment for input signal correctly. - Set up trigger selection correctly. - Check the relation between the operation range setting and the software limit setting.
Alarm clear attribute	Clearance is impossible.
Display of ERR Indicator	OFF

Primary factor	<ul style="list-style-type: none"> - The calculation result of electronic gear ratio fell outside the range of 1000 times to 1/1000 times. - In the calculation process of electronic gear ratio, the denominator or numerator exceeds an unsigned 64-bit size. - In the final calculation result of electronic gear ratio, the denominator or numerator exceeds an unsigned 32-bit size.
ESM state to detect	Init to PreOP
Synchronous mode to detect	DC, FreeRun, SM2
ESM state after detection	A state transition request from the master is followed.
ESC register AL Status Code	0000h
Disposition	- Review the electronic gear settings and turn ON the power again.
Alarm clear attribute	Clearance is impossible.
Display of ERR Indicator	OFF

8-3 Reading Error (alarm)

Error code is defined by IEC61800-7-201 until 0000h from FEFFh.

Error code can define peculiar until 0000h from FEFFh by manufacturer, is indicated by the following contents.

Reads the value (FF00h to FFFFh) defined by 603Fh (Error code) in the manufacturer-specific area.

The lower 8 bits of the value (FF00h to FFFFh) defined indicates the main alarm number of the servo error (alarm), as listed in the table below.

(The sub alarm number cannot be read.)

Note that the main alarm number is hexadecimal.

Index	Sub-Index	Name / Description	Units	Range	Data Type	Access	PDO	Op-mode	EEPROM
603Fh	00h	Error code  <ul style="list-style-type: none"> Displays an alarm (main number only) / warning occurred in the servo amplifier. When both an alarm and warning does not occur, displays 0000h. When an alarm and warning occur at the same time, display the alarm. FF**h <ul style="list-style-type: none"> ▲ Alarm (main) number (00h to 9Fh) warning number(A0h to A9h, C3h) Example: FF0Ch: 0Ch=12d. Err12.0 (over voltage protection) occurred FF55h: 55h=85d. Err85.0 (TxPDO assignment error protection) or Err85.1 (RxPDO assignment error protection) occurred (Note) When the exception of Err81.7(SyncManager2/3 error protection) occurs, display A000h.	-	0 - 65535	U16	ro	Yes	ALL	No

8-4 Clear error (alarm)/Clear warning

How to reset the protection function in the context of EtherCAT error(alarm) can be cleared.

- Both the method 1, 2 below enable to recover from error (alarm). Also, for information on other than the EtherCAT relevant protection functions, refer to Chapter 7 in Technical document Basic function specifications (SX-DSV02472).

method 1

- Set the bit 4 (Error Ind Ack) to "1" in AL Control to clear the communication error state in ESC to hold .
- After that, the controller changes the ESM communication state to Operational and sets the bit 7 of 6040h (Control word) to from 0 to 1 (sends the Fault reset command) to complete the error (alarm) clear.
- After the error (alarm) clear is completed, the PDS state changes from Fault to Switch on disabled.

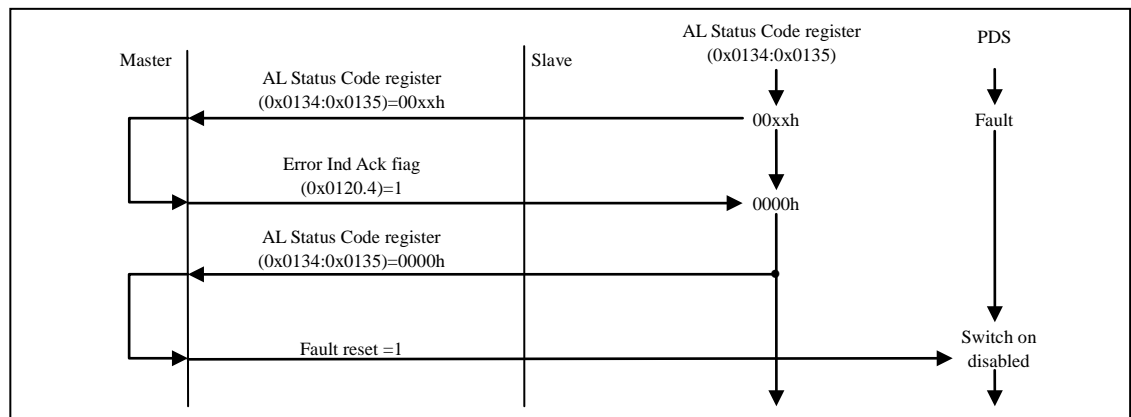

method 2

- Perform clear error(alarm) by Panaterm.
- After the error (alarm) clear is completed, the PDS state changes from Fault to Switch on disabled.

*Note:

- There is a delay of time between the notice and error (alarm) or between the warning and notice in AL Status, so the notice is not synchronous
 - The LED display (RUN, ERR), ESM state, and AL Status in the front panel are updated to the latest communication error status each time a communication error is detected. However, the Err number detected first time is displayed in the segment 7 LED and held until the Fault is reset. (The unclearable error (alarm) are kept even after the Fault is reset.)
 - If the alarm is occurring at the same time more than one, may not be able to clear even the cause of the alarm has been released If not release the cause of all alarms.
 - An alarm is not successfully cleared even when alarm clearance is executed from PANATERM and the Fault reset command is sent with external alarm clear input (A-CLR) ON. In this case, turn OFF external alarm clear input (A-CLR) temporarily, send the Fault reset command, and execute alarm clearance from PANATERM.
 - When the PDS status is Fault reaction active, the error (alarm) cannot be cleared.
- How to clear warning
 - After an warning occurred, the warning will not be cleared even if the cause is released. In this case, set the bit 7 of 6040h (Control word) from 0 to 1 (send the Fault reset command) to clear the warning at present. It is possible to clear warning through the SDO communication.

8-5 Other, error(alarm) / warning related function

Function related error(alarm) and warning have been described in addition to this section, refer to the section below.

- Abort message ... Section 3-6-1
- Emergency message ... Section 3-6-1
- 1001h(Error register) ... Section 3-6-1, 5-2
- 10F3h(Diagnosis history) ... Section 3-6-1, 5-7
- 603Fh(Error code) ... Section 3-6-1

9 Object Dictionary List

The attribute indicates the time when the object change description becomes effective.

A : Always effective

B : A change during a motor operation and command discharge is inhibited.

* The reflection timing in the case where it is changed during a motor operation and command discharge is indefinite.

C : Effective after control power reset

R : Effective after control power reset

* There is no difference in attributes C and R in this amplifier.

P : Effective at time of transition from Init to PreOP

S : Effective at time of transition from PreOP to SafeOP

H : Effective after the position information determined

X : Object which cannot be changed such as read only or not-supported object



CoE communication profile area (1000h to 1FFFh)

Index	Sub-Index	Name	Units	Range	Data Type	Access	PDO	Op-mode	EEPROM	Attribute
1000h	00h	Device type	—	0 - 4294967295	U32	ro	No	ALL	No	X
1001h	00h	Error register	—	0 - 255	U8	ro	No	ALL	No	X
1008h	00h	Manufacturer device name	—	—	VS	ro	No	ALL	No	X
1009h	00h	Manufacturer hardware version	—	—	VS	ro	No	ALL	No	X
100Ah	00h	Manufacturer software version	—	—	VS	ro	No	ALL	No	X
1010h	-	Store parameters	—	—	—	—	—	—	—	—
	00h	Number of entries	—	0 - 255	U8	ro	No	ALL	No	X
	01h	Save all parameters	—	0 - 4294967295	U32	rw	No	ALL	No	A
1018h	-	Identity object	—	—	—	—	—	—	—	—
	00h	Number of entries	—	0 - 255	U8	ro	No	ALL	No	X
	01h	Vendor ID	—	0 - 4294967295	U32	ro	No	ALL	No	X
	02h	Product code	—	0 - 4294967295	U32	ro	No	ALL	No	X
	03h	Revision number	—	0 - 4294967295	U32	ro	No	ALL	No	X
10F3h	04h	Serial number	—	0 - 4294967295	U32	ro	No	ALL	No	X
	-	Diagnosis history	—	—	—	—	—	—	—	—
	00h	Number of entries	—	0 - 255	U8	ro	No	ALL	No	X
	01h	Maximum messages	—	0 - 255	U8	ro	No	ALL	No	X
	02h	Newest message	—	0 - 255	U8	ro	No	ALL	No	X
	03h	Newest acknowledged message	—	0 - 255	U8	rw	No	ALL	No	A
	04h	New messages available	—	0 - 1	BOOL	ro	No	ALL	No	X
	05h	Flags	—	0 - 65535	U16	rw	No	ALL	Yes	A
06h	Diagnosis message 1	—	—	OS	ro	No	ALL	No	X	
:										
13h		Diagnosis message 14	—	—	OS	ro	No	ALL	No	X

CoE communication profile area (1000h to 1FFFh)

Index	Sub-Index	Name	Units	Range	Data Type	Access	PDO	Op-mode	EEPROM	Attribute
1600h	-	Receive PDO mapping 1	--	--	--	--	--	--	--	--
	00h	Number of entries	--	0 - 32	U8	rw	No	ALL	Yes	S
	01h	1st receive PDO mapped	--	0 - 4294967295	U32	rw	No	ALL	Yes	S
	02h	2nd receive PDO mapped	--	0 - 4294967295	U32	rw	No	ALL	Yes	S
	03h	3rd receive PDO mapped	--	0 - 4294967295	U32	rw	No	ALL	Yes	S
	04h	4th receive PDO mapped	--	0 - 4294967295	U32	rw	No	ALL	Yes	S
	05h	5th receive PDO mapped	--	0 - 4294967295	U32	rw	No	ALL	Yes	S
	06h	6th receive PDO mapped	--	0 - 4294967295	U32	rw	No	ALL	Yes	S
	07h	7th receive PDO mapped	--	0 - 4294967295	U32	rw	No	ALL	Yes	S
	08h	8th receive PDO mapped	--	0 - 4294967295	U32	rw	No	ALL	Yes	S
	:									
20h	32nd receive PDO mapped	--	--	0 - 4294967295	U32	rw	No	ALL	Yes	S
1601h	-	Receive PDO mapping 2	--	--	--	--	--	--	--	--
	00h	Number of entries	--	0 - 32	U8	rw	No	ALL	Yes	S
	01h	1st receive PDO mapped	--	0 - 4294967295	U32	rw	No	ALL	Yes	S
	02h	2nd receive PDO mapped	--	0 - 4294967295	U32	rw	No	ALL	Yes	S
	03h	3rd receive PDO mapped	--	0 - 4294967295	U32	rw	No	ALL	Yes	S
	04h	4th receive PDO mapped	--	0 - 4294967295	U32	rw	No	ALL	Yes	S
	05h	5th receive PDO mapped	--	0 - 4294967295	U32	rw	No	ALL	Yes	S
	06h	6th receive PDO mapped	--	0 - 4294967295	U32	rw	No	ALL	Yes	S
	07h	7th receive PDO mapped	--	0 - 4294967295	U32	rw	No	ALL	Yes	S
	08h	8th receive PDO mapped	--	0 - 4294967295	U32	rw	No	ALL	Yes	S
	:									
20h	32nd receive PDO mapped	--	--	0 - 4294967295	U32	rw	No	ALL	Yes	S
1602h	-	Receive PDO mapping 3	--	--	--	--	--	--	--	--
	00h	Number of entries	--	0 - 32	U8	rw	No	ALL	Yes	S
	01h	1st receive PDO mapped	--	0 - 4294967295	U32	rw	No	ALL	Yes	S
	02h	2nd receive PDO mapped	--	0 - 4294967295	U32	rw	No	ALL	Yes	S
	03h	3rd receive PDO mapped	--	0 - 4294967295	U32	rw	No	ALL	Yes	S
	04h	4th receive PDO mapped	--	0 - 4294967295	U32	rw	No	ALL	Yes	S
	05h	5th receive PDO mapped	--	0 - 4294967295	U32	rw	No	ALL	Yes	S
	06h	6th receive PDO mapped	--	0 - 4294967295	U32	rw	No	ALL	Yes	S
	07h	7th receive PDO mapped	--	0 - 4294967295	U32	rw	No	ALL	Yes	S
	08h	8th receive PDO mapped	--	0 - 4294967295	U32	rw	No	ALL	Yes	S
	:									
20h	32nd receive PDO mapped	--	--	0 - 4294967295	U32	rw	No	ALL	Yes	S
1603h	-	Receive PDO mapping 4	--	--	--	--	--	--	--	--
	00h	Number of entries	--	0 - 32	U8	rw	No	ALL	Yes	S
	01h	1st receive PDO mapped	--	0 - 4294967295	U32	rw	No	ALL	Yes	S
	02h	2nd receive PDO mapped	--	0 - 4294967295	U32	rw	No	ALL	Yes	S
	03h	3rd receive PDO mapped	--	0 - 4294967295	U32	rw	No	ALL	Yes	S
	04h	4th receive PDO mapped	--	0 - 4294967295	U32	rw	No	ALL	Yes	S
	05h	5th receive PDO mapped	--	0 - 4294967295	U32	rw	No	ALL	Yes	S
	06h	6th receive PDO mapped	--	0 - 4294967295	U32	rw	No	ALL	Yes	S
	07h	7th receive PDO mapped	--	0 - 4294967295	U32	rw	No	ALL	Yes	S
	08h	8th receive PDO mapped	--	0 - 4294967295	U32	rw	No	ALL	Yes	S
	:									
20h	32nd receive PDO mapped	--	--	0 - 4294967295	U32	rw	No	ALL	Yes	S

CoE communication profile area (1000h to 1FFFh)

Index	Sub-Index	Name	Units	Range	Data Type	Access	PDO	Op-mode	EEPROM	Attribute
1A00h	-	Transmit PDO mapping 1	--	--	--	--	--	--	--	--
	00h	Number of entries	--	0 - 32	U8	rw	No	ALL	Yes	S
	01h	1st transmit PDO mapped	--	0 - 4294967295	U32	rw	No	ALL	Yes	S
	02h	2nd transmit PDO mapped	--	0 - 4294967295	U32	rw	No	ALL	Yes	S
	03h	3rd transmit PDO mapped	--	0 - 4294967295	U32	rw	No	ALL	Yes	S
	04h	4th transmit PDO mapped	--	0 - 4294967295	U32	rw	No	ALL	Yes	S
	05h	5th transmit PDO mapped	--	0 - 4294967295	U32	rw	No	ALL	Yes	S
	06h	6th transmit PDO mapped	--	0 - 4294967295	U32	rw	No	ALL	Yes	S
	07h	7th transmit PDO mapped	--	0 - 4294967295	U32	rw	No	ALL	Yes	S
	08h	8th transmit PDO mapped	--	0 - 4294967295	U32	rw	No	ALL	Yes	S
:										
	20h	32nd transmit PDO mapped	--	0 - 4294967295	U32	rw	No	ALL	Yes	S
1A01h	-	Transmit PDO mapping 2	--	--	--	--	--	--	--	--
	00h	Number of entries	--	0 - 32	U8	rw	No	ALL	Yes	S
	01h	1st transmit PDO mapped	--	0 - 4294967295	U32	rw	No	ALL	Yes	S
	02h	2nd transmit PDO mapped	--	0 - 4294967295	U32	rw	No	ALL	Yes	S
	03h	3rd transmit PDO mapped	--	0 - 4294967295	U32	rw	No	ALL	Yes	S
	04h	4th transmit PDO mapped	--	0 - 4294967295	U32	rw	No	ALL	Yes	S
	05h	5th transmit PDO mapped	--	0 - 4294967295	U32	rw	No	ALL	Yes	S
	06h	6th transmit PDO mapped	--	0 - 4294967295	U32	rw	No	ALL	Yes	S
	07h	7th transmit PDO mapped	--	0 - 4294967295	U32	rw	No	ALL	Yes	S
	08h	8th transmit PDO mapped	--	0 - 4294967295	U32	rw	No	ALL	Yes	S
:										
	20h	32nd transmit PDO mapped	--	0 - 4294967295	U32	rw	No	ALL	Yes	S
1A02h	-	Transmit PDO mapping 3	--	--	--	--	--	--	--	--
	00h	Number of entries	--	0 - 32	U8	rw	No	ALL	Yes	S
	01h	1st transmit PDO mapped	--	0 - 4294967295	U32	rw	No	ALL	Yes	S
	02h	2nd transmit PDO mapped	--	0 - 4294967295	U32	rw	No	ALL	Yes	S
	03h	3rd transmit PDO mapped	--	0 - 4294967295	U32	rw	No	ALL	Yes	S
	04h	4th transmit PDO mapped	--	0 - 4294967295	U32	rw	No	ALL	Yes	S
	05h	5th transmit PDO mapped	--	0 - 4294967295	U32	rw	No	ALL	Yes	S
	06h	6th transmit PDO mapped	--	0 - 4294967295	U32	rw	No	ALL	Yes	S
	07h	7th transmit PDO mapped	--	0 - 4294967295	U32	rw	No	ALL	Yes	S
	08h	8th transmit PDO mapped	--	0 - 4294967295	U32	rw	No	ALL	Yes	S
:										
	20h	32nd transmit PDO mapped	--	0 - 4294967295	U32	rw	No	ALL	Yes	S
1A03h	-	Transmit PDO mapping 4	--	--	--	--	--	--	--	--
	00h	Number of entries	--	0 - 32	U8	rw	No	ALL	Yes	S
	01h	1st transmit PDO mapped	--	0 - 4294967295	U32	rw	No	ALL	Yes	S
	02h	2nd transmit PDO mapped	--	0 - 4294967295	U32	rw	No	ALL	Yes	S
	03h	3rd transmit PDO mapped	--	0 - 4294967295	U32	rw	No	ALL	Yes	S
	04h	4th transmit PDO mapped	--	0 - 4294967295	U32	rw	No	ALL	Yes	S
	05h	5th transmit PDO mapped	--	0 - 4294967295	U32	rw	No	ALL	Yes	S
	06h	6th transmit PDO mapped	--	0 - 4294967295	U32	rw	No	ALL	Yes	S
	07h	7th transmit PDO mapped	--	0 - 4294967295	U32	rw	No	ALL	Yes	S
	08h	8th transmit PDO mapped	--	0 - 4294967295	U32	rw	No	ALL	Yes	S
:										
	20h	32nd transmit PDO mapped	--	0 - 4294967295	U32	rw	No	ALL	Yes	S

CoE communication profile area (1000h to 1FFFh)

Index	Sub-Index	Name	Units	Range	Data Type	Access	PDO	Op-mode	EEPROM	Attribute
1C00h	-	Sync manager communication type	—	—	—	—	—	—	—	—
	00h	Number of used sync manager channels	—	0 - 255	U8	ro	No	ALL	No	X
	01h	Communication type sync manager 0	—	0 - 4	U8	ro	No	ALL	No	X
	02h	Communication type sync manager 1	—	0 - 4	U8	ro	No	ALL	No	X
	03h	Communication type sync manager 2	—	0 - 4	U8	ro	No	ALL	No	X
	04h	Communication type sync manager 3	—	0 - 4	U8	ro	No	ALL	No	X
1C12h	-	Sync manager channel 2	—	—	—	—	—	—	—	—
	00h	Number of assigned PDOs	—	0 - 4	U8	rw	No	ALL	Yes	S
	01h	PDO mapping object index of assigned RxPDO 1	—	1600h - 1603h	U16	rw	No	ALL	Yes	S
	02h	PDO mapping object index of assigned RxPDO 2	—	1600h - 1603h	U16	rw	No	ALL	Yes	S
	03h	PDO mapping object index of assigned RxPDO 3	—	1600h - 1603h	U16	rw	No	ALL	Yes	S
	04h	PDO mapping object index of assigned RxPDO 4	—	1600h - 1603h	U16	rw	No	ALL	Yes	S
1C13h	-	Sync manager channel 3	—	—	—	—	—	—	—	—
	00h	Number of assigned PDOs	—	0 - 4	U8	rw	No	ALL	Yes	S
	01h	PDO mapping object index of assigned TxPDO 1	—	1A00h - 1A03h	U16	rw	No	ALL	Yes	S
	02h	PDO mapping object index of assigned TxPDO 2	—	1A00h - 1A03h	U16	rw	No	ALL	Yes	S
	03h	PDO mapping object index of assigned TxPDO 3	—	1A00h - 1A03h	U16	rw	No	ALL	Yes	S
	04h	PDO mapping object index of assigned TxPDO 4	—	1A00h - 1A03h	U16	rw	No	ALL	Yes	S

CoE communication profile area (1000h to 1FFFh)

Index	Sub-Index	Name	Units	Range	Data Type	Access	PDO	Op-mode	EEPROM	Attribute
1C32h	-	Sync manager 2 synchronization	--	--	--	--	--	--	--	--
	00h	Number of sub-objects	--	0 - 255	U8	ro	No	ALL	No	X
	01h	Sync mode	--	0 - 65535	U16	rw	No	ALL	Yes	S
	02h	Cycle time	ns	0 - 4294967295	U32	rw	No	ALL	Yes	S
	03h	Shift time	ns	0 - 4294967295	U32	ro	No	ALL	No	X
	04h	Sync modes supported	--	0 - 65535	U16	ro	No	ALL	No	X
	05h	Minimum cycle time	ns	0 - 4294967295	U32	ro	No	ALL	No	X
	06h	Calc and copy time	ns	0 - 4294967295	U32	ro	No	ALL	No	X
	08h	Command	--	0 - 65535	U16	ro	No	ALL	No	X
	09h	Delay time	ns	0 - 4294967295	U32	ro	No	ALL	No	X
	0Ah	Sync0 cycle time	ns	0 - 4294967295	U32	ro	No	ALL	No	X
	0Bh	Cycle time too small	--	0 - 65535	U16	ro	No	ALL	No	X
	0Ch	SM-event missed	--	0 - 65535	U16	ro	No	ALL	No	X
	0Dh	Shift time too short	--	0 - 65535	U16	ro	No	ALL	No	X
	0Eh	RxPDO toggle failed	--	0 - 65535	U16	ro	No	ALL	No	X
20h	Sync error	--	0 - 1	BOOL	ro	No	ALL	No	X	
1C33h	-	Sync manager 3 synchronization	--	--	--	--	--	--	--	--
	00h	Number of sub-objects	--	0 - 255	U8	ro	No	ALL	No	X
	01h	Sync mode	--	0 - 65535	U16	rw	No	ALL	Yes	S
	02h	Cycle time	ns	0 - 4294967295	U32	ro	No	ALL	No	X
	03h	Shift time	ns	0 - 4294967295	U32	rw	No	ALL	No	S
	04h	Sync modes supported	--	0 - 65535	U16	ro	No	ALL	No	X
	05h	Minimum cycle time	ns	0 - 4294967295	U32	ro	No	ALL	No	X
	06h	Calc and copy time	ns	0 - 4294967295	U32	ro	No	ALL	No	X
	08h	Command	--	0 - 65535	U16	ro	No	ALL	No	X
	09h	Delay time	ns	0 - 4294967295	U32	ro	No	ALL	No	X
	0Ah	Sync0 cycle time	ns	0 - 4294967295	U32	ro	No	ALL	No	X
	0Bh	Cycle time too small	--	0 - 65535	U16	ro	No	ALL	No	X
	0Ch	SM-event missed	--	0 - 65535	U16	ro	No	ALL	No	X
	0Dh	Shift time too short	--	0 - 65535	U16	ro	No	ALL	No	X
	0Eh	RxPDO toggle failed	--	0 - 65535	U16	ro	No	ALL	No	X
20h	Sync error	--	0 - 1	BOOL	ro	No	ALL	No	X	

Servo parameter area (3000h to 3FFFh)

Category 0: Basic configuration

Index	Sub-Index	Name	Units	Range	Data Type	Access	PDO	Op-mode	EEPROM	Attribute
3000h	00h	For manufacturer's use	—	0 - 1	I16	rw	No	ALL	Yes	-
3001h	00h	Control mode setup	—	0 - 6	I16	rw	No	ALL	Yes	R
3002h	00h	Real-time auto-gain tuning setup	—	0 - 6	I16	rw	No	ALL	Yes	B
3003h	00h	Real-time auto-tuning machine stiffness setup	—	0 - 31	I16	rw	No	ALL	Yes	B
3004h	00h	Inertia ratio	%	0 - 10000	I16	rw	No	ALL	Yes	B
3008h	00h	For manufacturer's use	—	—	I32	—	—	—	—	-
3009h	00h	For manufacturer's use	—	—	I32	—	—	—	—	-
3010h	00h	For manufacturer's use	—	—	I32	—	—	—	—	-
3011h	00h	Number of output pulses per motor revolution (Not supported)	pulse/r	1 - 262144	I32	rw	No	ALL	Yes	R
3012h	00h	Reversal of pulse output logic (Not supported)	—	0 - 3	I16	rw	No	ALL	Yes	R
3013h	00h	1st torque limit	%	0 - 500	I16	rw	No	ALL	Yes	B
3014h	00h	Position deviation excess setup	command	0 - 134217728	I32	rw	No	csp pp hm ip	Yes	A
3015h	00h	Absolute encoder setup	—	0 - 3 	I16	rw	No	csp(s) pp(s) hm(s) ip(s) csv pv cst tq	Yes	C
3016h	00h	External regenerative resistor setup	—	0 - 3	I16	rw	No	ALL	Yes	C
3017h	00h	Selection of load factor for external regenerative resistor	—	0 - 4	I16	rw	No	ALL	Yes	C

Servo parameter area (3000h to 3FFFh)

Category 1: Gain tuning

Index	Sub-Index	Name	Units	Range	Data Type	Access	PDO	Op-mode	EEPROM	Attribute
3100h	00h	1st gain of position loop	0.1/s	0 - 30000	I16	rw	No	csp pp hm ip	Yes	B
3101h	00h	1st velocity loop gain	0.1Hz	1 - 32767	I16	rw	No	ALL	Yes	B
3102h	00h	1st velocity loop integration time constant	0.1ms	1 - 10000	I16	rw	No	ALL	Yes	B
3103h	00h	1st filter of velocity detection	—	0 - 5	I16	rw	No	ALL	Yes	B
3104h	00h	1st torque filter time constant	0.01ms	0 - 2500	I16	rw	No	ALL	Yes	B
3105h	00h	2nd gain of position loop	0.1/s	0 - 30000	I16	rw	No	csp pp hm ip	Yes	B
3106h	00h	2nd velocity loop gain	0.1Hz	1 - 32767	I16	rw	No	ALL	Yes	B
3107h	00h	2nd velocity loop integration time constant	0.1ms	1 - 10000	I16	rw	No	ALL	Yes	B
3108h	00h	2nd filter of velocity detection	—	0 - 5	I16	rw	No	ALL	Yes	B
3109h	00h	2nd torque filter time constant	0.01ms	0 - 2500	I16	rw	No	ALL	Yes	B
3110h	00h	Velocity feed forward gain	0.1%	0 - 1000	I16	rw	No	csp pp hm ip	Yes	B
3111h	00h	Velocity feed forward filter	0.01ms	0 - 6400	I16	rw	No	csp pp hm ip	Yes	B
3112h	00h	Torque feed forward gain	0.1%	0 - 1000	I16	rw	No	csp pp hm ip csv pv	Yes	B
3113h	00h	Torque feed forward filter	0.01ms	0 - 6400	I16	rw	No	csp pp hm ip csv pv	Yes	B

Servo parameter area (3000h to 3FFFh)

Category 1: Gain tuning

Index	Sub-Index	Name	Units	Range	Data Type	Access	PDO	Op-mode	EEPROM	Attribute
3114h	00h	2nd gain setup	—	0 - 1	I16	rw	No	ALL	Yes	B
3115h	00h	Mode of position control switching	—	0 - 10	I16	rw	No	csp pp hm ip	Yes	B
3116h	00h	Delay time of position control switching	0.1ms	0 - 10000	I16	rw	No	csp pp hm ip	Yes	B
3117h	00h	Level of position control switching	—	0 - 20000	I16	rw	No	csp pp hm ip	Yes	B
3118h	00h	Hysteresis at position control switching	—	0 - 20000	I16	rw	No	csp pp hm ip	Yes	B
3119h	00h	Position gain switching time	0.1ms	0 - 10000	I16	rw	No	csp pp hm ip	Yes	B
3120h	00h	Mode of velocity control switching	—	0 - 5	I16	rw	No	csv pv	Yes	B
3121h	00h	Delay time of velocity control switching	0.1ms	0 - 10000	I16	rw	No	csv pv	Yes	B
3122h	00h	Level of velocity control switching	—	0 - 20000	I16	rw	No	csv pv	Yes	B
3123h	00h	Hysteresis at velocity control switching	—	0 - 20000	I16	rw	No	csv pv	Yes	B
3124h	00h	Mode of torque control switching	—	0 - 3	I16	rw	No	cst tq	Yes	B
3125h	00h	Delay time of torque control switching	0.1ms	0 - 10000	I16	rw	No	cst tq	Yes	B
3126h	00h	Level of torque control switching	—	0 - 20000	I16	rw	No	cst tq	Yes	B
3127h	00h	Hysteresis at torque control switching	—	0 - 20000	I16	rw	No	cst tq	Yes	B

Servo parameter area (3000h to 3FFFh)

Category 2: Anti-vibration filter

Index	Sub-Index	Name	Units	Range	Data Type	Access	PDO	Op-mode	EEPROM	Attribute
3200h	00h	Adaptive filter mode setup	—	0 - 4	I16	rw	No	csp pp hm ip csv pv	Yes	B
3201h	00h	1st notch frequency	Hz	50 - 5000	I16	rw	No	ALL	Yes	B
3202h	00h	1st notch width selection	—	0 - 20	I16	rw	No	ALL	Yes	B
3203h	00h	1st notch depth selection	—	0 - 99	I16	rw	No	ALL	Yes	B
3204h	00h	2nd notch frequency	Hz	50 - 5000	I16	rw	No	ALL	Yes	B
3205h	00h	2nd notch width selection	—	0 - 20	I16	rw	No	ALL	Yes	B
3206h	00h	2nd notch depth selection	—	0 - 99	I16	rw	No	ALL	Yes	B
3207h	00h	3rd notch frequency	Hz	50 - 5000	I16	rw	No	ALL	Yes	B
3208h	00h	3rd notch width selection	—	0 - 20	I16	rw	No	ALL	Yes	B
3209h	00h	3rd notch depth selection	—	0 - 99	I16	rw	No	ALL	Yes	B
3210h	00h	4th notch frequency	Hz	50 - 5000	I16	rw	No	ALL	Yes	B
3211h	00h	4th notch width selection	—	0 - 20	I16	rw	No	ALL	Yes	B
3212h	00h	4th notch depth selection	—	0 - 99	I16	rw	No	ALL	Yes	B
3213h	00h	Selection of damping filter switching	—	0 - 3	I16	rw	No	csp pp hm ip	Yes	B
3214h	00h	1st damping frequency	0.1Hz	0 - 2000	I16	rw	No	csp pp hm ip	Yes	B
3215h	00h	1st damping filter setup	0.1Hz	0 - 1000	I16	rw	No	csp pp hm ip	Yes	B
3216h	00h	2nd damping frequency	0.1Hz	0 - 2000	I16	rw	No	csp pp hm ip	Yes	B
3217h	00h	2nd damping filter setup	0.1Hz	0 - 1000	I16	rw	No	csp pp hm ip	Yes	B

Servo parameter area (3000h to 3FFFh)

Category 2: Anti-vibration filter

Index	Sub-Index	Name	Units	Range	Data Type	Access	PDO	Op-mode	EEPROM	Attribute
3218h	00h	3rd damping frequency	0.1Hz	0 - 2000	I16	rw	No	csp pp hm ip	Yes	B
3219h	00h	3rd damping filter setup	0.1Hz	0 - 1000	I16	rw	No	csp pp hm ip	Yes	B
3220h	00h	4th damping frequency	0.1Hz	0 - 2000	I16	rw	No	csp pp hm ip	Yes	B
3221h	00h	4th damping filter setup	0.1Hz	0 - 1000	I16	rw	No	csp pp hm ip	Yes	B
3222h	00h	Positional command smoothing filter	0.1ms	0 - 10000	I16	rw	No	csp pp hm ip	Yes	B
3223h	00h	Positional command FIR filter	0.1ms	0 - 10000	I16	rw	No	csp pp hm ip	Yes	B

Servo parameter area (3000h to 3FFFh)

Category 3: Velocity, torque, and full-closed controls

Index	Sub-Index	Name	Units	Range	Data Type	Access	PDO	Op-mode	EEPROM	Attribute
3304h	00h	For manufacturer's use	—	—	I16	—	—	—	—	-
3305h	00h	For manufacturer's use	—	—	I16	—	—	—	—	-
3312h	00h	Acceleration time setup	1ms/ (1000r/min)	0 - 10000	I16	rw	No	csv pv	Yes	B
3313h	00h	Deceleration time setup	1ms/ (1000r/min)	0 - 10000	I16	rw	No	csv pv	Yes	B
3314h	00h	Sigmoid acceleration/ deceleration time setup	1ms	0 - 1000	I16	rw	No	csv pv	Yes	B
3317h	00h	Selection of speed limit	—	2	I16	rw	No	cst tq	Yes	B
3321h	00h	For manufacturer's use	—	—	I16	—	—	—	—	-
3322h	00h	For manufacturer's use	—	—	I16	—	—	—	—	-
3323h	00h	External scale selection (Not supported)	—	0 - 2	I16	rw	No	csp(F) pp(F) hm(F) ip(F)	Yes	R
3324h	00h	Numerator of external scale division (Not supported)	—	0 - 1048576	I32	rw	No	csp(F) pp(F) hm(F) ip(F)	Yes	R
3325h	00h	Denominator of external scale division (Not supported)	—	1 - 1048576	I32	rw	No	csp(F) pp(F) hm(F) ip(F)	Yes	R
3326h	00h	Reversal of direction of external scale (Not supported)	—	0 - 1	I16	rw	No	csp(F) pp(F) hm(F) ip(F)	Yes	R
3327h	00h	External scale Z phase disconnection detection disable (Not supported)	—	0 - 1	I16	rw	No	csp(F) pp(F) hm(F) ip(F)	Yes	R
3328h	00h	Hybrid deviation excess setup (Not supported)	command	1 - 134217728	I32	rw	No	csp(F) pp(F) hm(F) ip(F)	Yes	C
3329h	00h	Hybrid deviation clear setup (Not supported)	rotation	0 - 100	I16	rw	No	csp(F) pp(F) hm(F) ip(F)	Yes	C

Servo parameter area (3000h to 3FFFh)

Category 4: I/O monitor

Index	Sub-Index	Name	Units	Range	Data Type	Access	PDO	Op-mode	EEPROM	Attribute
3400h	00h	SI1 input selection	--	0 - 16777215	I32	rw	No	ALL	Yes	C
3401h	00h	SI2 input selection	--	0 - 16777215	I32	rw	No	ALL	Yes	C
3402h	00h	SI3 input selection	--	0 - 16777215	I32	rw	No	ALL	Yes	C
3403h	00h	SI4 input selection	--	0 - 16777215	I32	rw	No	ALL	Yes	C
3404h	00h	SI5 input selection	--	0 - 16777215	I32	rw	No	ALL	Yes	C
3405h	00h	SI6 input selection	--	0 - 16777215	I32	rw	No	ALL	Yes	C
3406h	00h	SI7 input selection	--	0 - 16777215	I32	rw	No	ALL	Yes	C
3407h	00h	SI8 input selection	--	0 - 16777215	I32	rw	No	ALL	Yes	C
3410h	00h	SO1 output selection	--	0 - 16777215	I32	rw	No	ALL	Yes	C
3411h	00h	SO2 output selection	--	0 - 16777215	I32	rw	No	ALL	Yes	C
3412h	00h	SO3 output selection	--	0 - 16777215	I32	rw	No	ALL	Yes	C
3416h	00h	Type of analog monitor 1	--	0 - 24	I16	rw	No	ALL	Yes	A
3417h	00h	Analog monitor 1 output gain	--	0 - 214748364	I32	rw	No	ALL	Yes	A
3418h	00h	Type of analog monitor 2	--	0 - 24	I16	rw	No	ALL	Yes	A
3419h	00h	Analog monitor 2 output gain	--	0 - 214748364	I32	rw	No	ALL	Yes	A
3421h	00h	Analog monitor output setup	--	0 - 2	I16	rw	No	ALL	Yes	A
3422h	00h	For manufacturer's use	--	--	I16	--	--	--	--	-
3423h	00h	For manufacturer's use	--	--	I16	--	--	--	--	-
3424h	00h	For manufacturer's use	--	--	I16	--	--	--	--	-
3431h	00h	Positioning complete (In-position) range	command	0 - 262144	I32	rw	No	csp pp hm ip	Yes	A
3432h	00h	Positioning complete (In-position) output setup	--	0 - 4	I16	rw	No	csp pp hm ip	Yes	A
3433h	00h	INP hold time	1ms	0 - 30000	I16	rw	No	csp pp hm ip	Yes	A
3434h	00h	Zero-speed	r/min	10 - 20000	I16	rw	No	ALL	Yes	A
3435h	00h	Speed coincidence range	r/min	10 - 20000	I16	rw	No	csv pv cst tq	Yes	A
3436h	00h	At-speed (Speed arrival)	r/min	10 - 20000	I16	rw	No	csv pv cst tq	Yes	A
3437h	00h	Mechanical brake action at stalling setup	1ms	0 - 10000	I16	rw	No	ALL	Yes	B
3438h	00h	Mechanical brake action at running setup	1ms	0 - 10000	I16	rw	No	ALL	Yes	B
3439h	00h	Brake release speed setup	r/min	30 - 3000	I16	rw	No	ALL	Yes	B
3440h	00h	Selection of alarm output 1	--	0 - 14	I16	rw	No	ALL	Yes	A
3441h	00h	Selection of alarm output 2	--	0 - 14	I16	rw	No	ALL	Yes	A
3442h	00h	Positioning complete (In-position) range 2	command	0 - 262144	I32	rw	No	csp pp hm ip	Yes	A

Servo parameter area (3000h to 3FFFh)

Category 5: Extended configuration

Index	Sub-Index	Name	Units	Range	Data Type	Access	PDO	Op-mode	EEPROM	Attribute
3503h	00h	Denominator of pulse output division (Not supported)	—	0 - 1048576	I32	rw	No	ALL	Yes	R
3504h	00h	Over-travel inhibit input setup	—	0 - 2	I16	rw	No	ALL	Yes	C
3505h	00h	Sequence at over-travel inhibit	—	0 - 2	I16	rw	No	ALL	Yes	C
3506h	00h	Sequence at Servo-Off	—	0 - 9	I16	rw	No	ALL	Yes	B
3507h	00h	Sequence upon main power off	—	0 - 9	I16	rw	No	ALL	Yes	B
3508h	00h	L/V trip selection upon main power off	—	0 - 3	I16	rw	No	ALL	Yes	B
3509h	00h	Detection time of main power off	1ms	70 - 2000	I16	rw	No	ALL	Yes	C
3510h	00h	Sequence at alarm	—	0 - 7	I16	rw	No	ALL	Yes	B
3511h	00h	Torque setup for emergency stop	%	0 - 500	I16	rw	No	ALL	Yes	B
3512h	00h	Over-load level setup	%	0 - 500	I16	rw	No	ALL	Yes	A
3513h	00h	Over-speed level setup	r/min	0 - 20000	I16	rw	No	ALL	Yes	A
3514h	00h	Motor working range setup	0.1 rotation	0 - 1000	I16	rw	No	csp pp hm ip	Yes	A
3515h	00h	Control input signal reading setup	—	0 - 3	I16	rw	No	ALL	Yes	C
3520h	00h	For manufacturer's use	—	—	I16	—	—	—	—	-
3521h	00h	Selection of torque limit	—	1 - 4	I16	rw	No	csp pp hm ip csv pv	Yes	B
3522h	00h	2nd torque limit	%	0 - 500	I16	rw	No	csp pp hm ip csv pv	Yes	B
3525h	00h	For manufacturer's use	—	—	I16	—	—	—	—	-
3526h	00h	For manufacturer's use	—	—	I16	—	—	—	—	-
3529h	00h	For manufacturer's use	—	—	I16	—	—	—	—	-
3531h	00h	USB axis address	—	0 - 127	I16	rw	No	ALL	Yes	C
3533h	00h	Pulse regenerative output limit setup (Not supported)	—	0 - 1	I16	rw	No	ALL	Yes	C
3534h	00h	For manufacturer's use	—	—	I16	—	—	—	—	-





Servo parameter area (3000h to 3FFFh)

Category 6: Specific configuration

Index	Sub-Index	Name	Units	Range	Data Type	Access	PDO	Op-mode	EEPROM	Attribute
3602h	00h	Speed deviation excess setup	r/min	0 - 20000	I16	rw	No	csp(s) pp(s) hm(s) ip(s)	Yes	A
3605h	00h	Position 3rd gain valid time	0.1ms	0 - 10000	I16	rw	No	csp pp hm ip	Yes	B
3606h	00h	Position 3rd gain scale factor	%	50 - 1000	I16	rw	No	csp pp hm ip	Yes	B
3607h	00h	Torque command additional value	%	-100 - 100	I16	rw	No	csp pp hm ip csv pv	Yes	B
3608h	00h	Positive direction torque compensation value	%	-100 - 100	I16	rw	No	csp pp hm ip	Yes	B
3609h	00h	Negative direction torque compensation value	%	-100 - 100	I16	rw	No	csp pp hm ip	Yes	B
3610h	00h	Function expansion setup	—	0 - 2047 	I16	rw	No	ALL	Yes	B
3611h	00h	Current response setup	%	50 - 100	I16	rw	No	ALL	Yes	B
3614h	00h	Emergency stop time at alarm	1ms	0 - 1000	I16	rw	No	ALL	Yes	B
3615h	00h	2nd over-speed level setup	r/min	0 - 20000	I16	rw	No	ALL	Yes	A
3618h	00h	Power-up wait time	100ms	0 - 100	I16	rw	No	ALL	Yes	R
3619h	00h	For manufacturer's use	—	—	I16	—	—	—	—	—
3620h	00h	For manufacturer's use	—	—	I16	—	—	—	—	—
3621h	00h	For manufacturer's use	—	—	I32	—	—	—	—	—
3622h	00h	AB phase external scale pulse outputting method selection (Not supported)	—	0 - 1	I16	rw	No	csp(F) pp(F) hm(F) ip(F)	Yes	R

Servo parameter area (3000h to 3FFFh)

Category 6: Specific configuration

Index	Sub-Index	Name	Units	Range	Data Type	Access	PDO	Op-mode	EEPROM	Attribute
3623h	00h	Disturbance torque compensating gain	%	-100 - 100	I16	rw	No	csp(s) pp(s) hm(s) ip(s) csv pv	Yes	B
3624h	00h	Disturbance observer filter	0.01ms	10 - 2500	I16	rw	No	csp(s) pp(s) hm(s) ip(s) csv pv	Yes	B
3627h	00h	Warning latch state setup (Not supported)	—	0 - 3	I16	rw	No	ALL	Yes	C
3631h	00h	Real time auto tuning estimation speed	—	0 - 3	I16	rw	No	ALL	Yes	B
3632h	00h	Real time auto tuning custom setup	—	-32768 - 32767	I16	rw	No	ALL	Yes	B
3634h	00h	Hybrid vibration suppression gain (Not supported)	0.1/s	0 - 30000	I16	rw	No	csp(F) pp(F) hm(F) ip(F)	Yes	B
3635h	00h	Hybrid vibration suppression filter (Not supported)	0.01ms	0 - 6400	I16	rw	No	csp(F) pp(F) hm(F) ip(F)	Yes	B
3637h	00h	Oscillation detecting level	0.1%	0 - 1000	I16	rw	No	ALL	Yes	B
3638h	00h	Alarm mask setup	—	-32768 - 32767	I16	rw	No	ALL	Yes	C
3639h	00h	For manufacturer's use	—	—	I16	—	—	—	—	-
3640h	00h	For manufacturer's use	—	—	I16	—	—	—	—	-
3641h	00h	1st damping depth	—	0 - 1000	I16	rw	No	csp pp hm ip	Yes	B
3642h	00h	2-stage torque filter time constant	0.01ms	0 - 2500	I16	rw	No	ALL	Yes	B
3643h	00h	2-stage torque filter attenuation term	—	0 - 1000	I16	rw	No	ALL	Yes	B
 3647h	00h	Function expansion setup 2	-	0 - 15	I16	rw	No	csp(s) pp(s) hm(s) ip(s)	Yes	R
 3648h	00h	Tuning filter	0.1ms	0 - 2000	I16	rw	No	csp(s) pp(s) hm(s) ip(s)	Yes	B
 3649h	00h	Command / tuning filter damping	-	0 - 99	I16	rw	No	csp(s) pp(s) hm(s) ip(s)	Yes	B
 3650h	00h	Viscous friction compensating gain	0.1%/ (10000r/min)	0 - 10000	I16	rw	No	csp(s) pp(s) hm(s) ip(s)	Yes	B
 3651h	00h	Wait time for emergency stop	ms	0 - 10000	I16	rw	No	ALL	Yes	B

Servo parameter area (3000h to 3FFFh)

Category 7: Specific configuration 2

Index	Sub-Index	Name	Units	Range	Data Type	Access	PDO	Op-mode	EEPROM	Attribute
3700h	00h	Display on LED	—	0 - 32767	I16	rw	No	ALL	Yes	A
3701h	00h	Display time setup upon power-up	100ms	0 - 1000	I16	rw	No	ALL	Yes	R
3703h	00h	Output setup during torque limit	—	0 - 1	I16	rw	No	csv tm q	Yes	A
3704h	00h	For manufacturer's use	—	—	I16	—	—	—	—	—
3705h	00h	For manufacturer's use	—	—	I16	—	—	—	—	—
3706h	00h	For manufacturer's use	—	—	I16	—	—	—	—	—
3707h	00h	For manufacturer's use	—	—	I16	—	—	—	—	—
3708h	00h	For manufacturer's use	—	—	I16	—	—	—	—	—
3709h	00h	For manufacturer's use	—	—	I16	—	—	—	—	—
3710h	00h	For manufacturer's use	—	—	I16	—	—	—	—	—
3711h	00h	For manufacturer's use	—	—	I32	—	—	—	—	—
3712h	00h	For manufacturer's use	—	—	I32	—	—	—	—	—
3713h	00h	For manufacturer's use	—	—	I32	—	—	—	—	—
3714h	00h	Main power off warning detection time	1ms	0 - 2000	I16	rw	No	ALL	Yes	C
3715h	00h	For manufacturer's use	—	—	I32	—	—	—	—	—
3716h	00h	Torque saturation error protection frequency	time	0 - 30000	I16	rw	No	csv pp hm ip csv pv	Yes	B
3722h	00h	Communication function extended setup 1	—	-32768 - 32767	I16	rw	No	ALL	Yes	R
3723h	00h	Communication function extended setup 2	—	-32768 - 32767	I16	rw	No	ALL	Yes	B
3724h	00h	Communication function extended setup 3	—	-32768 - 32767	I16	rw	No	ALL	Yes	C
3739h	00h	For manufacturer's use	—	—	I16	—	—	—	—	—
3740h	00h	Station Alias setup(high)	—	0 - 255	I16	rw	No	ALL	Yes	R
3741h	00h	Station Alias selection	—	0 - 2	I16	rw	No	ALL	Yes	R
3742h	00h	Maximum continuation communication error	—	-32768 - 32767	I16	rw	No	ALL	Yes	R
3743h	00h	Lost link detection time	ms	0 - 32767	I16	rw	No	ALL	Yes	R
3744h	00h	Software version	—	-2147483648 - 2147483647	I32	ro	No	ALL	Yes	X
3793h	00h	Homing return speed limit value	r/min	0 - 20000	I16	rw	No	hm	Yes	C

4.00

Servo parameter area (3000h to 3FFFh)

Category 8: Specific configuration 3

Index	Sub-Index	Name	Units	Range	Data Type	Access	PDO	Op-mode	EEPROM	Attribute
3800h	00h	For manufacturer's use	--	--	I16	--	--	--	--	-
3801h	00h	For manufacturer's use	--	--	I32	--	--	--	--	-
3802h	00h	For manufacturer's use	--	--	I16	--	--	--	--	-
3803h	00h	For manufacturer's use	--	--	I16	--	--	--	--	-
3804h	00h	For manufacturer's use	--	--	I32	--	--	--	--	-
3805h	00h	For manufacturer's use	--	--	I16	--	--	--	--	-
3810h	00h	For manufacturer's use	--	--	I32	--	--	--	--	-
3812h	00h	For manufacturer's use	--	--	I16	--	--	--	--	-
3813h	00h	For manufacturer's use	--	--	I32	--	--	--	--	-
3814h	00h	For manufacturer's use	--	--	I32	--	--	--	--	-
3815h	00h	For manufacturer's use	--	--	I32	--	--	--	--	-
3819h	00h	For manufacturer's use	--	--	I16	--	--	--	--	-









User-specific area (4000h~4FFFh)

Index	Sub-Index	Name	Units	Range	Data Type	Access	PDO	Op-mode	EEPROM	Attribute
4D00h	-	Special function start	-	-	-	-	-	-	-	-
	00h	Number of entries	-	2	U8	ro	No		No	X
	01h	Special function start flag 1	-	0 – 4294967295	U32	rw	No	ALL	No	B
	02h	Special function start flag 2	-	0 – 4294967295	U32	rw	No		No	B
4D01h	00h	Special function setting 9	-	0 – 65535	U16	rw	No	ALL	No	B
4D29h	00h	Over load factor	0.1%	0 – 65535	U16	ro	TxPDO	ALL	No	X

Drive profile area (6000h to 6FFFh)

Index	Sub-Index	Name	Units	Range	Data Type	Access	PDO	Op-mode	EEPROM	Attribute
6007h	00h	Abort connection option code	-	0 – 3	I16	rw	No	ALL	Yes	A
603Fh	00h	Error code	-	0 – 65535	U16	ro	TxPDO	ALL	No	X
6040h	00h	Controlword	-	0 – 65535	U16	rw	RxPDO	ALL	No	A
6041h	00h	Statusword	-	0 – 65535	U16	ro	TxPDO	ALL	No	X
605Ah	00h	Quick stop option code	-	0 – 7	I16	rw	No	ALL	Yes	A
605Bh	00h	Shutdown option code	-	0 – 1	I16	rw	No	ALL	Yes	A
605Ch	00h	Disable operation option code	-	0 – 1	I16	rw	No	ALL	Yes	A
605Dh	00h	Halt option code	-	1 – 3	I16	rw	No	ALL	Yes	A
605Eh	00h	Fault reaction option code	-	0 – 2	I16	rw	No	ALL	Yes	A
6060h	00h	Modes of operation	-	-128 – 127	I8	rw	RxPDO	ALL	Yes	A
6061h	00h	Modes of operation display	-	-128 – 127	I8	ro	TxPDO	ALL	No	X
6062h	00h	Position demand value	command	-2147483648 – 2147483647	I32	ro	TxPDO	pp hm ip csp	No	X
6063h	00h	Position actual internal value	pulse	-2147483648 – 2147483647	I32	ro	TxPDO	ALL	No	X
6064h	00h	Position actual value	command	-2147483648 – 2147483647	I32	ro	TxPDO	ALL	No	X
6065h	00h	Following error window	command	0 – 4294967295	U32	rw	RxPDO	pp csp	Yes	A
6066h	00h	Following error time out	1ms	0 – 65535	U16	rw	RxPDO	pp csp	Yes	A
6067h	00h	Position window	command	0 – 4294967295	U32	rw	RxPDO	pp ip	Yes	A
6068h	00h	Position window time	1ms	0 – 65535	U16	rw	RxPDO	pp ip	Yes	A
6069h	00h	Velocity sensor actual value	-	-2147483648 – 2147483647	I32	ro	TxPDO	ALL	No	X
606Ah	00h	Sensor selection code	-	-32768 – 32767	I16	ro	RxPDO	pv	No	X
606Bh	00h	Velocity demand value	command/s	-2147483648 – 2147483647	I32	ro	TxPDO	pv csv	No	X
606Ch	00h	Velocity actual value	command/s	-2147483648 – 2147483647	I32	ro	TxPDO	ALL	No	X
606Dh	00h	Velocity window	command/s	0 – 65535	U16	rw	RxPDO	pv	Yes	A
606Eh	00h	Velocity window time	1ms	0 – 65535	U16	rw	RxPDO	pv	Yes	A
606Fh	00h	Velocity threshold	command/s	0 – 65535	U16	rw	RxPDO	pv	Yes	A
6070h	00h	Velocity threshold time	1ms	0 – 65535	U16	rw	RxPDO	pv	Yes	A
6071h	00h	Target torque	0.1%	-32768 – 32767	I16	rw	RxPDO	tq cst	Yes	A
6072h	00h	Max torque	0.1%	0 – 65535	U16	rw	RxPDO	ALL	Yes	A
6073h	00h	Max current	0.1%	0 – 65535	U16	ro	No	tq	No	X
6074h	00h	Torque demand	0.1%	-32768 – 32767	I16	ro	TxPDO	ALL	No	X
6075h	00h	Motor rated current	mA	0 – 4294967295	U32	ro	No	ALL	No	X
6076h	00h	Motor rated torque	mN · m	0 – 4294967295	U32	ro	No	ALL	No	X
6077h	00h	Torque actual value	0.1%	-32768 – 32767	I16	ro	TxPDO	ALL	No	X
6078h	00h	Current actual value	0.1%	-32768 – 32767	I16	ro	TxPDO	ALL	No	X
6079h	00h	DC link circuit voltage	mV	0 – 4294967295	U32	ro	TxPDO	ALL	No	X
607Ah	00h	Target position	command	-2147483648 – 2147483647	I32	rw	RxPDO	pp csp	No	A
607Bh	-	Position range limit	-	-	-	-	-	ALL	-	-
	00h	Highest sub-index supported	-	2	U8	ro	No		No	X
	01h	Min position range limit	command	-2147483648 – 2147483647	I32	rw	RxPDO		Yes	X
	02h	Max position range limit	command	-2147483648 – 2147483647	I32	rw	RxPDO		Yes	X
607Ch	00h	Home offset	command	-2147483648 – 2147483647	I32	rw	RxPDO	ALL	Yes	P,H

Drive profile area (6000h to 6FFFh)

Index	Sub-Index	Name	Units	Range	Data Type	Access	PDO	Op-mode	EEPROM	Attribute
607Dh	-	Software position limit	-	-	-	-	-	pp ip csp	-	-
	00h	Number of entries	-	2	U8	ro	No		No	X
	01h	Min position limit	command	-2147483648 – 2147483647	I32	rw	RxPDO		Yes	P,H
	02h	Max position limit	command	-2147483648 – 2147483647	I32	rw	RxPDO		Yes	P,H
607Eh	00h	Polarity	-	0 – 255	U8	rw	No	ALL	Yes	P
607Fh	00h	Max profile velocity	command/s	0 – 4294967295	U32	rw	RxPDO	pp hm ip pv	Yes	B
6080h	00h	Max motor speed	r/min	0 – 4294967295	U32	rw	RxPDO	ALL	Yes	B
6081h	00h	Profile velocity	command/s	0 – 4294967295	U32	rw	RxPDO	pp ip	Yes	A
6082h	00h	End velocity	command/s	0 – 4294967295	U32	rw	RxPDO	pp ip	Yes	X
6083h	00h	Profile acceleration	command/s ²	0 – 4294967295	U32	rw	RxPDO	pp pv ip	Yes	A
6084h	00h	Profile deceleration	command/s ²	0 – 4294967295	U32	rw	RxPDO	pp ip pv	Yes	A
6085h	00h	Quick stop deceleration	command/s ²	0 – 4294967295	U32	rw	RxPDO	pp pv hm ip csp csv	Yes	A
6086h	00h	Motion profile type	-	-32768 – 32767	I16	rw	RxPDO	pp pv ip	Yes	A
6087h	00h	Torque slope	0.1%/s	0 – 4294967295	U32	rw	RxPDO	tq cst	Yes	A
6088h	00h	Torque profile type	-	-32768 – 32767	I16	rw	RxPDO	tq	Yes	A
608Fh	-	Position encoder resolution	-	-	-	-	-	ALL	-	-
	00h	Highest sub-index supported	-	2	U8	ro	No		No	X
	01h	Encoder increments	pulse	 1 – 4294967295	U32	ro	No		No	X
	02h	Motor revolutions	r (motor)	 1 – 4294967295	U32	ro	No		No	X
6091h	-	Gear ratio	-	-	-	-	-	ALL	-	-
	00h	Number of entries	-	2	U8	ro	No		No	X
	01h	Motor revolutions	r (motor)	 1 – 4294967295	U32	rw	No		Yes	P,H
	02h	Shaft revolutions	r (shaft)	 1 – 4294967295	U32	rw	No		Yes	P,H
6092h	-	Feed constant	-	-	-	-	-	ALL	-	-
	00h	Highest sub-index supported	-	2	U8	ro	No		No	X
	01h	Feed	command	 1 – 4294967295	U32	rw	No		Yes	P,H
	02h	Shaft revolutions	r (shaft)	 1 – 4294967295	U32	rw	No		Yes	P,H
6098h	00h	Homing method	-	-128 – 127	I8	rw	RxPDO	hm	Yes	B
6099h	-	Homing speeds	-	-	-	-	-	hm	-	-
	00h	Number of entries	-	2	U8	ro	No		No	X
	01h	Speed during search for switch	command /s	0 – 4294967295	U32	rw	RxPDO		Yes	A
	02h	Speed during search for zero	command/s	0 – 4294967295	U32	rw	RxPDO		Yes	A
609Ah	00h	Homing acceleration	command/s ²	0 – 4294967295	U32	rw	RxPDO	hm	Yes	A

Drive profile area (6000h to 6FFFh)

Index	Sub-Index	Name	Units	Range	Data Type	Access	PDO	Op-mode	EEPROM	Attribute
60A3h	00h	Profile jerk use	-	1 - 2 , 255	U8	rw	No	pp pv ip	Yes	A
60A4h	-	Profile jerk	-	-	-	-	-	-	-	-
	00h	Highest sub-index supported	-	1 - 2	U8	ro	No	pp pv ip	No	X
	01h	Profile jerk 1	command/s ³	0 - 4294967295	U32	rw	No	-	Yes	A
	02h	Profile jerk 2	command/s ³	0 - 4294967295	U32	rw	No	-	Yes	A
60B0h	00h	Position offset	command	-2147483648 - 2147483647	I32	rw	RxPDO	csp	Yes	A
60B1h	00h	Velocity offset	command/s	-2147483648 - 2147483647	I32	rw	RxPDO	pp pv hm ip csp csv	Yes	A
60B2h	00h	Torque offset	0.1%	-32768 - 32767	I16	rw	RxPDO	ALL	Yes	A
60B8h	00h	Touch probe function	-	0 - 65535	U16	rw	RxPDO	ALL	No	A
60B9h	00h	Touch probe status	-	0 - 65535	U16	ro	TxPDO	ALL	No	X
60BAh	00h	Touch probe pos1 pos value	command	-2147483648 - 2147483647	I32	ro	TxPDO	ALL	No	X
60BBh	00h	Touch probe pos1 neg value	command	-2147483648 - 2147483647	I32	ro	TxPDO	ALL	No	X
60BCh	00h	Touch probe pos2 pos value	command	-2147483648 - 2147483647	I32	ro	TxPDO	ALL	No	X
60BDh	00h	Touch probe pos2 neg value	command	-2147483648 - 2147483647	I32	ro	TxPDO	ALL	No	X
60C0h	00h	Interpolation sub mode select	-	0	I16	rw	No	ip	Yes	A
60C1h	-	Interpolated data record	-	-	-	-	-	-	-	-
	00h	Highest sub-index supported	-	1 - 254	U8	ro	No	ip	No	X
	01h	1st set-point	command	-2147483648 - 2147483647	I32	rw	No	-	No	A
	FEh	254th set-point	command	-2147483648 - 2147483647	I32	rw	No	-	No	A
60C2h	-	Interpolation time period	-	-	-	-	-	ip	-	-
	00h	Highest sub-index supported	-	2	U8	ro	No	csp	No	X
	01h	Interpolation time period value	-	0 - 255	U8	rw	No	csv	Yes	A
	02h	Interpolation time index	-	-128 - 63	I8	rw	No	cst	Yes	A
60C4h	-	Interpolation data configuration	-	-	-	-	-	ip	-	-
	00h	Highest sub-index supported	-	6	U8	ro	No	-	No	X
	01h	Maximum buffer size	-	0 - 4294967295	U32	rw	RxPDO	-	Yes	A
	02h	Actual buffer size	-	0 - 4294967295	U32	rw	RxPDO	-	Yes	A
	03h	Buffer organisation	-	0 , 1	U8	rw	RxPDO	-	Yes	A
	04h	Buffer position	-	0 - 32767	U16	rw	RxPDO	-	Yes	A
	05h	Size of data record	-	1 - 254	U8	wo	RxPDO	-	Yes	A
	06h	Buffer clear	-	0 , 1	U8	wo	RxPDO	-	Yes	A
60C5h	00h	Max acceleration	command/s ²	0 - 4294967295	U32	rw	RxPDO	pp hm pv ip	Yes	A
60C6h	00h	Max deceleration	command/s ²	0 - 4294967295	U32	rw	RxPDO	pp hm pv ip	Yes	A

Drive profile area (6000h to 6FFFh)

Index	Sub-Index	Name	Units	Range	Data Type	Access	PDO	Op-mode	EEPROM	Attribute
60E3h	-	Supported homing method	-	-	-	-	-	ALL	-	-
	00h	Number of entries	-	32	U8	ro	No		No	X
	01h	1st supported homing method	-	0 – 32767	U16	ro	No		No	X
	:	:	:	:	:	:	:		:	:
	20h	32nd supported homing method	-	0 – 32767	U16	ro	No	No	X	
60F2h	00h	Positioning option code	-	0 – 32767	U16	rw	RxPDO	pp	Yes	A
60F4h	00h	Following error actual value	command	-2147483648 – 2147483647	I32	ro	TxPDO	pp hm ip csp	No	X
60FAh	00h	Control effort	command/s	-2147483648 – 2147483647	I32	ro	TxPDO	pp hm ip csp	No	X
60FCh	00h	Position demand internal value	pulse	-2147483648 – 2147483647	I32	ro	TxPDO	pp hm ip csp	No	X
60FDh	00h	Digital inputs	-	0 – 4294967295	U32	ro	TxPDO	ALL	No	X
60FEh	-	Digital outputs	-	-	-	-	-	ALL	-	-
	00h	Number of entries	-	2	U8	ro	No		No	X
	01h	Physical outputs	-	0 – 4294967295	U32	rw	RxPDO		Yes	A
	02h	Bit mask	-	0 – 4294967295	U32	rw	RxPDO		Yes	A
60FFh	00h	Target velocity	command/s	-2147483648 – 2147483647	I32	rw	RxPDO	pv csv	No	A
6502h	00h	Supported drive modes	-	0 – 4294967295	U32	ro	TxPDO	ALL	No	X

10 Glossary of Terms

10-1 Glossary of Terms 283

10-1 Glossary of Terms

Term/abbreviation	Description
AL	Application Layer
CSP,csp	Cyclic Synchronous Position (profile)
CSV,csv	Cyclic Synchronous Velocity
CST,cst	Cyclic Synchronous Torque
DC	Distributed Clocks
ESC	EtherCAT Slave Controller
ESM	EtherCAT State Machine
FG	Function Group
HM,hm	Homing Mode
MBX	Mailbox
PDO	Process Data Object
PDS	Power Drive Systems
PP,pp	Profile Position
RxPDO	Receive PDO
SM	SyncManager
TxPDO	Transmit PDO
WDT	Watchdog Timer
nma	No Mode Assigned
ms	manufacturer-specific (Controlword 6040h)
oms	operation mode specific (Controlword 6040h)
eo	enable operation (Controlword 6040h)
r	reserved (Controlword 6040h)
qs	quick stop (Controlword 6040h)
ev	enable voltage (Controlword 6040h)
h	halt (Controlword 6040h)
so	switch on (Controlword 6040h)
fr	fault reset (Controlword 6040h)
RW	Read-Write
rw	read-write
ro	read-only
c	constant
Alarm	Error
Warning	Warning
Yes	Supported (or condition met)
No	Not supported (or condition not met)
-	Not applicable (or out of scope)

Data Type	
U8	Unsigned8
U16	Unsigned16
U32	Unsigned32
Int8	Integer8
Int16	Integer16
Int32	Integer32
VS	Visible String
BOOL	Boolean
OS	Octet String