

Pulgege trapezoidali POLY-V POLY-V Belt pulleys / Keilriemenscheiben POLY-V Poulies trapézoïdales POLY-V / Poleas trapezoidales POLY-V

Le pulegge per cinghie POLY-V presentate dalla S.A.T.I. nel presente catalogo sono tutte costruite secondo le tabelle ISO 9982.

Il materiale impiegato nella costruzione delle medesime è in ghisa EN-GJL-200 UNI EN 1561 e, successivamente alle lavorazioni meccaniche, subiscono un trattamento superficiale di FOSFATAZIONE.

Tutte le pulegge sono equilibrate STATICAMENTE ed idonee ad un funzionamento fino alla velocità periferica di 30 m/s.

POLY-V pulleys proposed by S.A.T.I. in this catalogue are all manufactured according to ISO 9982.

The material used for the construction of these pulleys is cast iron EN-GJL-200 UNI EN 1561 and after the machining all pulleys are being PHOSPHATED.

All pulleys are STATICALLY balanced and suitable for peripheral speed up to 30 m/s.

Die POLY-V Riemenscheiben, die von S.A.T.I. in diesem Katalog dargestellt sind, sind alle nach ISO 9982.

Das fuer die Produktion verwendete Material ist Grauguss EN-GJL-200 UNI EN 1561 und nach der Bearbeitung werden alle Keilriemenscheiben PHOSPHATIERT.

Alle Keilriemenscheiben sind STATISCH ausgewuchtet und fuer eine peripherische Betriebsgeschwindigkeit bis 30 m/s.

Les poulies POLY-V présentées par la S.A.T.I. sur ce catalogue sont toutes fabriquées suivant les normes ISO 9982.

Le matériel utilisé pour la fabrication des poulies est la fonte EN-GJL-200 UNI EN 1561 et après l'usinage elles sont toutes exposées à un traitement de PHOSPHATATION.

Toutes les pouliés sont équilibrées STATIQUEMENT et propres à tourner à une vitesse périphérique jusqu'à 30 m/s.

Las poleas POLY-V presentadas por la S.A.T.I. en el presente catálogo están todas construidas según las tablas ISO 9982.

El material empleado en la construcción de las mismas es el hierro fundido EN-GJL-200 UNI EN 1561 y después de las elaboraciones mecánicas están sometidas a un tratamiento superficial de FOSFATACIÓN.

Todas las poleas están equilibradas ESTÁTICAMENTE y son adecuadas para un funcionamiento de una velocidad de hasta 30 m/s.

Calcolo della velocità periferica Vp in m/s:	Calculation of peripheral speed Vp in m/s	Berechnung der Umfangsgeschwindigkeit Vp in m/s	Calcul de la vitesse périphérique Vp m/s	Cálculo de la velocidad periférica Vp en m/s
$V_p = \frac{\pi \cdot P \cdot \text{rpm}}{60 \cdot 1000} \approx \frac{P \cdot \text{rpm}}{19100} ; V_p \leq 30 \text{ m/s}$				
P= Diametro primitivo in mm rpm= Giri al minuto	P= Pitch diameter in mm rpm= Revolutions per minute	P= Teildurchmesser in mm rpm= Umdrehungen pro Minute	P= Diamètre primitif en mm rpm= Tours par minute	P= Diámetro primitivo en mm rpm= Revoluciones por minuto

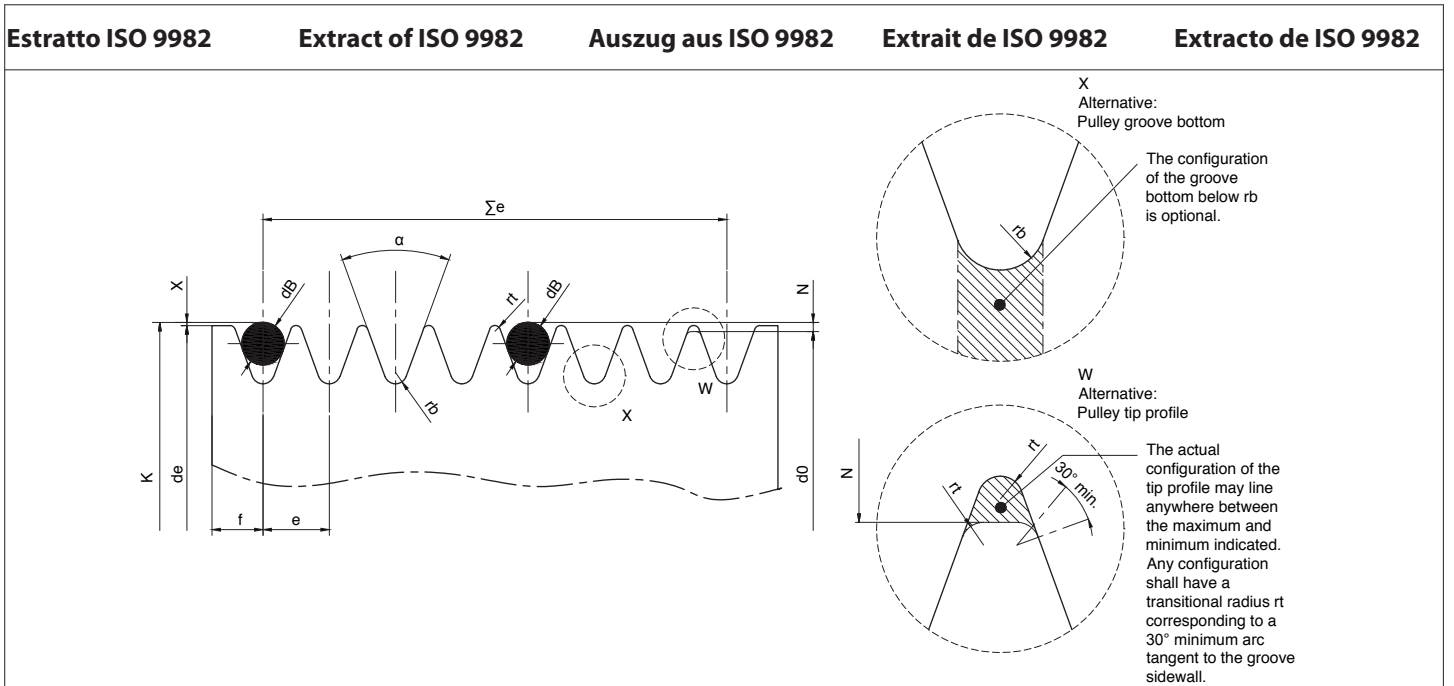

	Grooves	e ¹⁾²⁾	Σe $\pm 0,3$	α ³⁾ $\pm 0,5^\circ$	R_t min.	R_b max.	d_B $\pm 0,01$	$2X$ nom.	$2N$ ⁴⁾ max.	f min.
PJ	8	2,34	$\pm 0,03$	16,38	0,2	0,4	1,5	0,23	0,81	1,80
	12	2,34	$\pm 0,03$	25,74	0,2	0,4	1,5	0,23	0,81	1,80
	16	2,34	$\pm 0,03$	35,1	0,2	0,4	1,5	0,23	0,81	1,80
PL	8	4,7	$\pm 0,05$	32,9	0,4	0,4	3,5	2,36	3,5	3,30
	12	4,7	$\pm 0,05$	51,7	0,4	0,4	3,5	2,36	3,5	3,30
	16	4,7	$\pm 0,05$	70,5	0,4	0,4	3,5	2,36	3,5	3,30

1) The tolerance on e applies to the distance between the axes of two consecutive grooves.
 2) The sum of all deviations from the nominat value e for all grooves in any pulley shall not exceed $\pm 0,3$.
 3) The centreline of the groove shall make an angle of $90^\circ \pm 0,5^\circ$ with the axis of the pulley.
 4) N is not related to the nominal diameter of the pulley but is measured from the actual ride position of the ball or rod in the pulley.

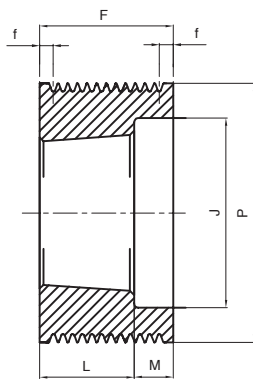

Tipo / Type / Typ
Type / Tipo :
3

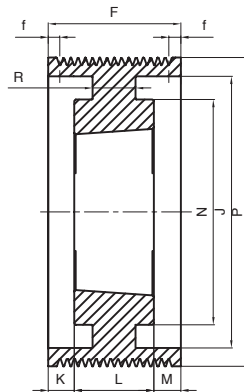

Tipo / Type / Typ
Type / Tipo :
7

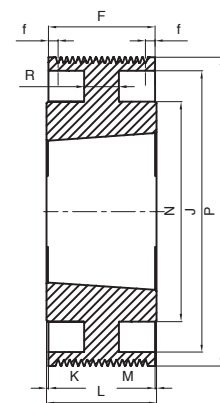

Tipo / Type / Typ
Type / Tipo :
8

POLY-V PL 8

Cod. interno Internal code Innerer Code Code interne Código interno	Descrizione Description Beschreibung Description Descripción	Gole Grooves Rillen Gorges Canales	P	Tipo Type Typ Type Tipo	Bussola Bush Buchse Moyeu Casquillo	∅ MAX	F ±0.1	f	J	K	L	M	N	R	Peso Weight Gewicht Poids Peso Kg
LT0758	75 PL 8	8	75	3	1210	32	48,0	7,55	56	-	26	22	-	-	0,66
LT0808	80 PL 8	8	80	3	1210	32	48,0	7,55	56	-	26	22	-	-	0,86
LT0858	85 PL 8	8	85	3	1210	32	48,0	7,55	61	-	26	22	-	-	1,00
LT0908	90 PL 8	8	90	3	1610	42	48,0	7,55	66	-	26	22	-	-	1,01
LT0958	95 PL 8	8	95	3	1610	42	48,0	7,55	71	-	26	22	-	-	1,16
LT1008	100 PL 8	8	100	3	1610	42	48,0	7,55	76	-	26	22	-	-	1,31
LT1068	106 PL 8	8	106	3	1610	42	48,0	7,55	82	-	26	22	-	-	1,53
LT1128	112 PL 8	8	112	3	1610	42	48,0	7,55	88	-	26	22	-	-	1,75
LT1188	118 PL 8	8	118	3	2012	50	48,0	7,55	94	-	32	16	-	-	1,88
LT1258	125 PL 8	8	125	3	2012	50	48,0	7,55	101	-	32	16	-	-	2,22
LT1328	132 PL 8	8	132	3	2012	50	48,0	7,55	108	-	32	16	-	-	2,54
LT1408	140 PL 8	8	140	3	2517	65	48,0	7,55	116	-	45	3	-	-	3,02
LT1508	150 PL 8	8	150	3	2517	65	48,0	7,55	126	-	45	3	-	-	3,75
LT1608	160 PL 8	8	160	3	2517	65	48,0	7,55	136	-	45	3	-	-	4,54
LT1708	170 PL 8	8	170	3	2517	65	48,0	7,55	146	-	45	3	-	-	5,35
LT1808	180 PL 8	8	180	7	2517	65	48,0	7,55	156	1,5	45	1,5	120	14	4,52
LT1908	190 PL 8	8	190	7	2517	65	48,0	7,55	166	1,5	45	1,5	120	12	4,72
LT2008	200 PL 8	8	200	7	2517	65	48,0	7,55	176	1,5	45	1,5	120	12	5,07
LT2128	212 PL 8	8	212	7	2517	65	48,0	7,55	188	1,5	45	1,5	120	12	5,50
LT2248	224 PL 8	8	224	7	2517	65	48,0	7,55	202	1,5	45	1,5	120	12	5,77
LT2508	250 PL 8	8	250	8	3020	75	48,0	7,55	228	2	52	2	146	12	7,39
LT2808	280 PL 8	8	280	8	3020	75	48,0	7,55	256	2	52	2	146	12	8,90
LT3158	315 PL 8	8	315	8	3020	75	48,0	7,55	285	2	52	2	146	12	11,30

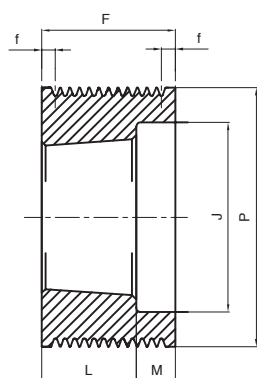

Tipo / Type / Typ
Type / Tipo :
3

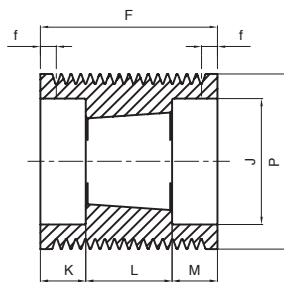

Tipo / Type / Typ
Type / Tipo :
6

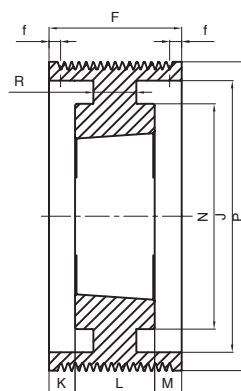

Tipo / Type / Typ
Type / Tipo :
7

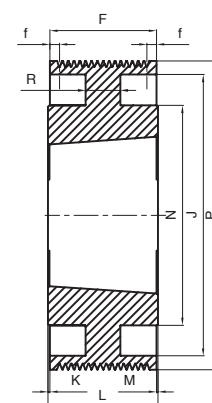

Tipo / Type / Typ
Type / Tipo :
8

POLY-V PL 12

Cod. interno Internal code Innerer Code Code interne Código interno	Descrizione Description Beschreibung Description Descripción	Gole Grooves Rillen Gorges Canales	P	Tipo Type Typ Type Tipo	Bussola Bush Buchse Moyeu Casquillo	∅ MAX	F ±0.1	f	J	K	L	M	N	R	Peso Weight Gewicht Poids Peso Kg
LT07512	75 PL 12	12	75	3	1215	28	67,0	7,65	56	-	42	25	-	-	0,97
LT08012	80 PL 12	12	80	3	1215	28	67,0	7,65	56	-	42	25	-	-	1,25
LT08512	85 PL 12	12	85	3	1215	28	67,0	7,65	61	-	42	25	-	-	1,47
LT09012	90 PL 12	12	90	3	1615	42	67,0	7,65	66	-	42	25	-	-	1,45
LT09512	95 PL 12	12	95	3	1615	42	67,0	7,65	71	-	42	25	-	-	1,71
LT10012	100 PL 12	12	100	3	2012	50	67,0	7,65	79	-	32	35	-	-	1,39
LT10612	106 PL 12	12	106	3	2012	50	67,0	7,65	82	-	32	35	-	-	1,73
LT11212	112 PL 12	12	112	3	2012	50	67,0	7,65	88	-	32	35	-	-	2,02
LT11812	118 PL 12	12	118	6	2517	65	67,0	7,65	97	11	45	11	-	-	1,96
LT12512	125 PL 12	12	125	6	2517	65	67,0	7,65	101	11	45	11	-	-	2,46
LT13212	132 PL 12	12	132	6	2517	65	67,0	7,65	108	11	45	11	-	-	2,97
LT14012	140 PL 12	12	140	6	2517	65	67,0	7,65	116	11	45	11	-	-	3,55
LT15012	150 PL 12	12	150	6	2517	65	67,0	7,65	126	11	45	11	-	-	4,30
LT16012	160 PL 12	12	160	6	2517	65	67,0	7,65	136	11	45	11	-	-	5,12
LT17012	170 PL 12	12	170	6	2517	65	67,0	7,65	146	11	45	11	-	-	6,03
LT18012	180 PL 12	12	180	7	2517	65	67,0	7,65	156	11	45	11	120	16	5,34
LT19012	190 PL 12	12	190	7	2517	65	67,0	7,65	166	11	45	11	120	14	5,60
LT20012	200 PL 12	12	200	7	3020	75	67,0	7,65	176	7,5	52	7,5	146	22	6,99
LT21212	212 PL 12	12	212	7	3020	75	67,0	7,65	188	7,5	52	7,5	146	14	7,06
LT22412	224 PL 12	12	224	7	3020	75	67,0	7,65	202	7,5	52	7,5	146	14	7,41
LT25012	250 PL 12	12	250	7	3020	75	67,0	7,65	228	7,5	52	7,5	146	14	8,67
LT28012	280 PL 12	12	280	7	3020	75	67,0	7,65	256	7,5	52	7,5	146	14	10,58
LT31512	315 PL 12	12	315	8	3535	90	67,0	7,65	285	11	89	11	178	14	18,23

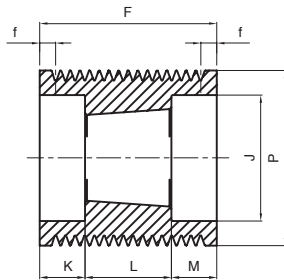

Tipo / Type / Typ
Type / Tipo :
6

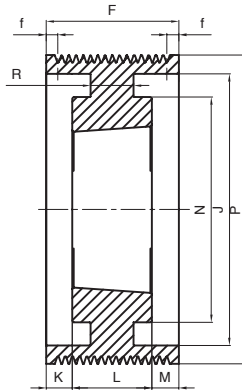

Tipo / Type / Typ
Type / Tipo :
7

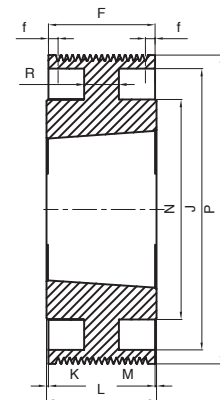

Tipo / Type / Typ
Type / Tipo :
8

POLY-V PL 16

Cod. interno Internal code Innerer Code Code interne Còdigo interno	Descrizione Description Beschreibung Description Descripción	Gole Grooves Rillen Gorges Canales	P	Tipo Type Typ Type Tipo	Bussola Bush Buchse Moyeu Casquillo	Ø MAX	F ±0.1	f	J	K	L	M	N	R	Peso Weight Gewicht Poids Peso Kg
LT08516	85 PL 16	16	85	6	1215	28	86,0	7,75	61	22	42	22	-	-	1,76
LT09016	90 PL 16	16	90	6	1615	42	86,0	7,75	66	22	42	22	-	-	1,78
LT09516	95 PL 16	16	95	6	1615	42	86,0	7,75	71	22	42	22	-	-	2,02
LT10016	100 PL 16	16	100	6	2012	50	86,0	7,75	79	27	32	27	-	-	1,69
LT10616	106 PL 16	16	106	6	2012	50	86,0	7,75	82	27	32	27	-	-	2,12
LT11216	112 PL 16	16	112	6	2012	50	86,0	7,75	88	27	32	27	-	-	2,42
LT11816	118 PL 16	16	118	6	2517	65	86,0	7,75	97	20,5	45	20,5	-	-	2,31
LT12516	125 PL 16	16	125	6	2517	65	86,0	7,75	101	20,5	45	20,5	-	-	2,92
LT13216	132 PL 16	16	132	6	2517	65	86,0	7,75	108	20,5	45	20,5	-	-	3,44
LT14016	140 PL 16	16	140	6	2517	65	86,0	7,75	116	20,5	45	20,5	-	-	4,05
LT15016	150 PL 16	16	150	6	2517	65	86,0	7,75	126	20,5	45	20,5	-	-	4,85
LT16016	160 PL 16	16	160	6	3020	75	86,0	7,75	136	17	52	17	-	-	4,88
LT17016	170 PL 16	16	170	6	3020	75	86,0	7,75	146	17	52	17	-	-	5,96
LT18016	180 PL 16	16	180	6	3020	75	86,0	7,75	156	17	52	17	-	-	7,09
LT19016	190 PL 16	16	190	6	3020	75	86,0	7,75	166	17	52	17	-	-	8,20
LT20016	200 PL 16	16	200	7	3020	75	86,0	7,75	176	17	52	17	146	25	7,92
LT21216	212 PL 16	16	212	7	3020	75	86,0	7,75	188	17	52	17	146	16	8,03
LT22416	224 PL 16	16	224	7	3020	75	86,0	7,75	202	17	52	17	146	16	8,42
LT25016	250 PL 16	16	250	8	3535	90	86,0	7,75	228	1,5	89	1,5	178	30	16,09
LT28016	280 PL 16	16	280	8	3535	90	86,0	7,75	256	1,5	89	1,5	178	18	17,10
LT31516	315 PL 16	16	315	8	3535	90	86,0	7,75	285	1,5	89	1,5	178	18	20,93